

MicroBlaze Processor Reference Guide

UG984 (v2025.1) May 29, 2025



Table of Contents

Chapter 1: Introduction.....	4
Guide Contents.....	4
Chapter 2: MicroBlaze Architecture.....	5
Introduction.....	5
Overview.....	5
Data Types and Endianness.....	9
Instructions.....	10
Registers.....	24
Pipeline Architecture.....	50
Memory Architecture.....	56
Privileged Instructions.....	58
Virtual-Memory Management.....	59
Reset, Interrupts, Exceptions, and Break.....	74
Instruction Cache.....	84
Data Cache.....	87
Floating-Point Unit (FPU).....	91
Stream Link Interfaces.....	97
Debug and Trace.....	98
Fault Tolerance.....	118
Lockstep Operation.....	126
Coherency.....	129
Data and Instruction Address Extension.....	131
Chapter 3: MicroBlaze Signal Interface Description.....	133
Introduction.....	133
Overview.....	133
MicroBlaze I/O Overview.....	134
AXI4 and ACE Interface Description.....	147
Local Memory Bus (LMB) Interface Description.....	152
Lockstep Interface Description.....	164
Debug Interface Description.....	170

Trace Interface Description.....	171
MicroBlaze Core Configurability.....	174
Chapter 4: MicroBlaze Application Binary Interface.....	185
Introduction.....	185
Data Types.....	185
Register Usage Conventions.....	186
Stack Convention.....	188
Memory Model.....	190
Interrupt, Break, and Exception Handling.....	191
Reset Handling.....	193
ELF Format.....	193
Chapter 5: MicroBlaze Instruction Set Architecture.....	197
Introduction.....	197
Notation.....	197
Formats.....	199
MicroBlaze 32-bit Instructions.....	199
MicroBlaze 64-bit Instructions.....	347
Appendix A: Performance and Resource Utilization.....	431
Performance.....	431
Resource Utilization.....	432
IP Characterization and F_{MAX} Margin System Methodology.....	441
Appendix B: Additional Resources and Legal Notices.....	443
Finding Additional Documentation.....	443
Support Resources.....	444
References.....	444
Revision History.....	445
Please Read: Important Legal Notices.....	449

Introduction

The MicroBlaze™ Processor Reference Guide provides information about the 32-bit and 64-bit soft processor, MicroBlaze, which is included in the AMD Vivado™ Design Suite. The document is intended as a guide to the MicroBlaze hardware architecture.

Guide Contents

This guide contains the following sections:

- **Chapter 2: MicroBlaze Architecture:** Contains an overview of MicroBlaze features as well as information on Big-Endian and Little-Endian bit-reversed format, 32-bit or 64-bit general purpose registers, cache software support, and AXI4-Stream interfaces.
- **Chapter 3: MicroBlaze Signal Interface Description:** Describes the types of signal interfaces that can be used to connect MicroBlaze.
- **Chapter 4: MicroBlaze Application Binary Interface:** Describes the Application Binary Interface important for developing software in assembly language for the processor.
- **Chapter 5: MicroBlaze Instruction Set Architecture:** Provides notation, formats, and instructions for the Instruction Set Architecture (ISA) of MicroBlaze.
- **Appendix A: Performance and Resource Utilization:** Contains maximum frequencies and resource utilization numbers for different configurations and devices.
- **Appendix B: Additional Resources and Legal Notices:** Provides links to documentation and additional resources.

MicroBlaze Architecture

Introduction

This section contains an overview of MicroBlaze™ features and detailed information on MicroBlaze architecture including Big-Endian or Little-Endian bit-reversed format, 32-bit or 64-bit general purpose registers, virtual-memory management, cache software support, and AXI4-Stream interfaces.

Overview

The MicroBlaze embedded processor soft core is a reduced instruction set computer (RISC) optimized for implementation in AMD Field Programmable Gate Arrays (FPGAs). The following figure shows a functional block diagram of the MicroBlaze core.

Figure 1: MicroBlaze Core Block Diagram

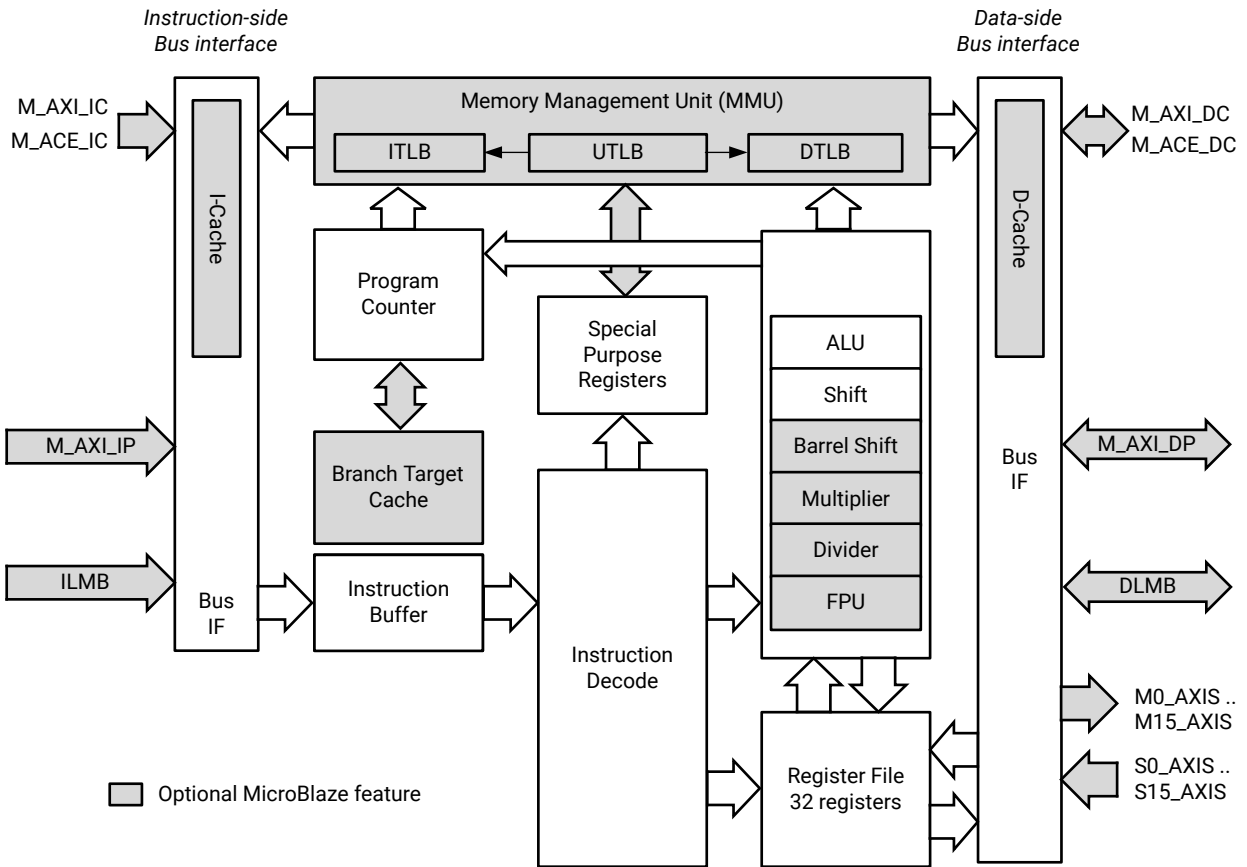

X19738-100218

Features

The MicroBlaze soft core processor is highly configurable, allowing you to select a specific set of features required by your design.

The fixed feature set of the processor includes:

- Thirty-two 32-bit or 64-bit general purpose registers
- 32-bit instruction word with three operands and two addressing modes
- Default 32-bit address bus, extensible to 64 bits
- Single issue pipeline

In addition to these fixed features, the MicroBlaze processor is parameterized to allow selective enabling of additional functionality. Older (deprecated) versions of MicroBlaze support a subset of the optional features described in this manual. Only the latest (preferred) version of MicroBlaze (v11.0) supports all options.



RECOMMENDED: AMD recommends that all new designs use the latest preferred version of the MicroBlaze processor.

The following table provides an overview of the configurable features by MicroBlaze versions.

Table 1: Configurable Feature Overview by MicroBlaze Version

Feature	MicroBlaze versions					
	v9.3	v9.4	v9.5	v9.6	v10.0	v11.0
Version Status	deprecated	deprecated	deprecated	deprecated	deprecated	preferred
Processor pipeline depth	3/5	3/5	3/5	3/5	3/5/8	3/5/8
Local Memory Bus (LMB) data side interface	option	option	option	option	option	option
Local Memory Bus (LMB) instruction side interface	option	option	option	option	option	option
Hardware barrel shifter	option	option	option	option	option	option
Hardware divider	option	option	option	option	option	option
Hardware debug logic	option	option	option	option	option	option
Stream link interfaces	0-16 AXI	0-16 AXI	0-16 AXI	0-16 AXI	0-16 AXI	0-16 AXI
Machine status set and clear instructions	option	option	option	option	option	option
Cache line word length	4, 8	4, 8	4, 8, 16	4, 8, 16	4, 8, 16	4, 8, 16
Hardware exception support	option	option	option	option	option	option
Pattern compare instructions	option	option	option	option	option	option
Floating-point unit (FPU)	option	option	option	option	option	option
Disable hardware multiplier ¹	option	option	option	option	option	option
Hardware debug readable ESR and EAR	Yes	Yes	Yes	Yes	Yes	Yes
Processor Version Register (PVR)	option	option	option	option	option	option
Area or speed optimized	option	option	option	option	option	option
Hardware multiplier 64-bit result	option	option	option	option	option	option
LUT cache memory	option	option	option	option	option	option
Floating-point conversion and square root instructions	option	option	option	option	option	option
Memory Management Unit (MMU)	option	option	option	option	option	option
Extended stream instructions	option	option	option	option	option	option
Use Cache Interface for All I-Cache Memory Accesses	option	option	option	option	option	option
Use Cache Interface for All D-Cache Memory Accesses	option	option	option	option	option	option
Use Write-back Caching Policy for D-Cache	option	option	option	option	option	option
Branch Target Cache (BTC)	option	option	option	option	option	option
Streams for I-Cache	option	option	option	option	option	option
Victim handling for I-Cache	option	option	option	option	option	option
Victim handling for D-Cache	option	option	option	option	option	option

Table 1: Configurable Feature Overview by MicroBlaze Version (cont'd)

Feature	MicroBlaze versions					
	v9.3	v9.4	v9.5	v9.6	v10.0	v11.0
AXI4 (M_AXI_DP) data side interface	option	option	option	option	option	option
AXI4 (M_AXI_IP) instruction side interface	option	option	option	option	option	option
AXI4 (M_AXI_DC) protocol for D-Cache	option	option	option	option	option	option
AXI4 (M_AXI_IC) protocol for I-Cache	option	option	option	option	option	option
AXI4 protocol for stream accesses	option	option	option	option	option	option
Fault tolerant features	option	option	option	option	option	option
Force distributed RAM for cache tags	option	option	option	option	option	option
Configurable cache data widths	option	option	option	option	option	option
Count Leading Zeros instruction	option	option	option	option	option	option
Memory Barrier instruction	Yes	Yes	Yes	Yes	Yes	Yes
Stack overflow and underflow detection	option	option	option	option	option	option
Allow stream instructions in user mode	option	option	option	option	option	option
Lockstep support	option	option	option	option	option	option
Configurable use of FPGA primitives	option	option	option	option	option	option
Low-latency interrupt mode	option	option	option	option	option	option
Swap instructions	option	option	option	option	option	option
Sleep mode and sleep instruction	Yes	Yes	Yes	Yes	Yes	Yes
Relocatable base vectors	option	option	option	option	option	option
ACE (M_ACE_DC) protocol for D-Cache	option	option	option	option	option	option
ACE (M_ACE_IC) protocol for I-Cache	option	option	option	option	option	option
Extended debug: performance monitoring, program trace, non-intrusive profiling	option	option	option	option	option	option
Reset mode: enter sleep or debug halt at reset	option	option	option	option	option	option
Extended debug: external program trace		option	option	option	option	option
Extended data addressing				option	option	option
Pipeline pause functionality				Yes	Yes	Yes
Hibernate and suspend instructions				Yes	Yes	Yes
Non-secure mode				Yes	Yes	Yes
Bit field instructions ²					option	option
Parallel debug interface					option	option
MMU Physical Address Extension					option	option
64-bit mode						option

Notes:

1. Used for saving DSP48E primitives.
2. Bit field instructions are available when `C_USE_BARREL = 1`.

Data Types and Endianness

The MicroBlaze processor uses Big-Endian or Little-Endian format to represent data, depending on the selected endianness. The parameter `C_ENDIANNES` is set to 1 (little-endian) by default.

The hardware supported data types for 32-bit MicroBlaze are word, half word, and byte. With 64-bit MicroBlaze the data types long and double are also available in hardware.

When using the reversed load and store instructions LHUR, LWR, LLR, SHR, SWR, and SLR, the bytes in the data are reversed, as indicated by the byte-reversed order.

The following tables show the bit and byte organization for each type.

Table 2: Long Data Type (only 64-bit MicroBlaze)

Big-Endian Byte Address	n	n+1	n+2	n+3	n+4	n+5	n+6	n+7
Big-Endian Byte Significance	MSByte							LSByte
Big-Endian Byte Order	n	n+1	n+2	n+3	n+4	n+5	n+6	n+7
Big-Endian Byte-Reversed Order	n+7	n+6	n+5	n+4	n+3	n+2	n+1	n
Little-Endian Byte Address	n+7	n+6	n+5	n+4	n+3	n+2	n+1	n
Little-Endian Byte Significance	MSByte							LSByte
Little-Endian Byte Order	n+7	n+6	n+5	n+4	n+3	n+2	n+1	n
Little-Endian Byte-Reversed Order	n	n+1	n+2	n+3	n+4	n+5	n+6	n+7
Bit Label	0				63			
Bit Significance	MSBit				LSBit			

Table 3: Word Data Type

Big-Endian Byte Address	n	n+1	n+2	n+3
Big-Endian Byte Significance	MSByte			LSByte
Big-Endian Byte Order	n	n+1	n+2	n+3
Big-Endian Byte-Reversed Order	n+3	n+2	n+1	n
Little-Endian Byte Address	n+3	n+2	n+1	n
Little-Endian Byte Significance	MSByte			LSByte
Little-Endian Byte Order	n+3	n+2	n+1	n
Little-Endian Byte-Reversed Order	n	n+1	n+2	n+3
Bit Label	0		31	
Bit Significance	MSBit		LSBit	

Table 4: Half Word Data Type

Big-Endian Byte Address	n	n+1
Big-Endian Byte Significance	MSByte	LSByte
Big-Endian Byte Order	n	n+1
Big-Endian Byte-Reversed Order	n+1	n
Little-Endian Byte Address	n+1	n
Little-Endian Byte Significance	MSByte	LSByte
Little-Endian Byte Order	n+1	n
Little-Endian Byte-Reversed Order	n	n+1
Bit Label	0	15
Bit Significance	MSBit	LSBit

Table 5: Byte Data Type

Byte Address	n	
Bit Label	0	7
Bit Significance	MSBit	LSBit

Instructions

Instruction Summary

All MicroBlaze instructions are 32 bits and are defined as either Type A or Type B. Type A instructions have up to two source register operands and one destination register operand. Type B instructions have one source register and a 16-bit immediate operand (which can be extended to 32 bits by preceding the Type B instruction with an imm instruction).

Type B instructions have a single destination register operand. Instructions are provided in the following functional categories: arithmetic, logical, branch, load/store, and special. The following table describes the instruction set nomenclature used in the semantics of each instruction. The following table lists the MicroBlaze instruction set. See [Chapter 5: MicroBlaze Instruction Set Architecture](#), for more information on these instructions.

Table 6: Instruction Set Nomenclature

Symbol	Description
Ra	R0 - R31, General Purpose Register, source operand a <ul style="list-style-type: none"> With 32-bit MicroBlaze represents the entire 32-bit register With 64-bit MicroBlaze and L = 0, represents the 32 least significant bits With 64-bit MicroBlaze and L = 1, represents the entire 64-bit register The instruction bit L is defined in the following table.

Table 6: Instruction Set Nomenclature (cont'd)

Symbol	Description
Rb	R0 - R31, General Purpose Register, source operand b <ul style="list-style-type: none"> With 32-bit MicroBlaze represents the entire 32-bit register With 64-bit MicroBlaze and L = 0, represents the 32 least significant bits With 64-bit MicroBlaze and L = 1, represents the entire 64-bit register The instruction bit L is defined in the following table.
Rd	R0 - R31, General Purpose Register, destination operand <ul style="list-style-type: none"> With 32-bit MicroBlaze the entire 32-bit register is assigned the result With 64-bit MicroBlaze and L = 0, the 32 least significant bits are assigned the result With 64-bit MicroBlaze and L = 1, the entire 64-bit register is assigned the result The instruction bit L is defined in the following table.
SPR[x]	Special Purpose Register number x
MSR	Machine Status Register = SPR[1]
ESR	Exception Status Register = SPR[5]
EAR	Exception Address Register = SPR[3]
FSR	Floating-point Unit Status Register = SPR[7]
PVRx	Processor Version Register, where x is the register number = SPR[8192 + x]
BTR	Branch Target Register = SPR[11]
PC	Execute stage Program Counter = SPR[0]
x[y]	Bit y of register x
x[]	Bit range y to z of register x
x	Bit inverted value of register x
Imm	16-bit immediate value
Immx	x bit immediate value
FSLx	4-bit AXI4-Stream port designator, where x is the port number
C	Carry flag, MSR[29]
Sa	Special Purpose Register, source operand
Sd	Special Purpose Register, destination operand
s(x)	Sign extend argument x to 32-bit or 64-bit value
*Addr	Memory contents at location Addr (data-size aligned)
:=	Assignment operator
=	Equality comparison
!=	Inequality comparison
>	Greater than comparison
>=	Greater than or equal comparison
<	Less than comparison
<=	Less than or equal comparison
+	Arithmetic add
*	Arithmetic multiply
/	Arithmetic divide
>> x	Bit shift right x bits

Table 6: Instruction Set Nomenclature (cont'd)

Symbol	Description
<< x	Bit shift left x bits
and	Logic AND
or	Logic OR
xor	Logic exclusive OR
op1 if cond else op2	Perform $op1$ if condition <i>cond</i> is true, else perform $op2$
&	Concatenate. For example "0000100 & Imm7" is the concatenation of the fixed field "0000100" and a 7 bit immediate value.
signed	Operation performed on signed integer data type. All arithmetic operations are performed on signed word operands, unless otherwise specified
unsigned	Operation performed on unsigned integer data type
float	Operation performed on floating-point data type
clz(r)	Count leading zeros

Table 7: MicroBlaze Instruction Set Summary

Type A	0-5	6-10	11-15	16-20	21-31	Semantics
Type B	0-5	6-10	11-15	16-31		
ADD Rd,Ra,Rb	000000	Rd	Ra	Rb	00L00000000	$Rd := Rb + Ra$
RSUB Rd,Ra,Rb	000001	Rd	Ra	Rb	00L00000000	$Rd := Rb + \overline{Ra} + 1$
ADDC Rd,Ra,Rb	000010	Rd	Ra	Rb	00L00000000	$Rd := Rb + Ra + C$
RSUBC Rd,Ra,Rb	000011	Rd	Ra	Rb	00L00000000	$Rd := Rb + \overline{Ra} + C$
ADDK Rd,Ra,Rb	000100	Rd	Ra	Rb	00L00000000	$Rd := Rb + Ra$
RSUBK Rd,Ra,Rb	000101	Rd	Ra	Rb	00L00000000	$Rd := Rb + \overline{Ra} + 1$
CMP Rd,Ra,Rb	000101	Rd	Ra	Rb	00L00000001	$Rd := Rb + \overline{Ra} + 1$ $Rd[0] := 0$ if $(Rb \geq Ra)$ else $Rd[0] := 1$
CMPU Rd,Ra,Rb	000101	Rd	Ra	Rb	00L00000011	$Rd := Rb + \overline{Ra} + 1$ (unsigned) $Rd[0] := 0$ if $(Rb \geq Ra,$ unsigned) else $Rd[0] := 1$
ADDKC Rd,Ra,Rb	000110	Rd	Ra	Rb	00L00000000	$Rd := Rb + Ra + C$
RSUBKC Rd,Ra,Rb	000111	Rd	Ra	Rb	00L00000000	$Rd := Rb + \overline{Ra} + C$
ADDI Rd,Ra,Imm	001000	Rd	Ra	Imm		$Rd := s(Imm) + Ra$
RSUBI Rd,Ra,Imm	001001	Rd	Ra	Imm		$Rd := s(Imm) + \overline{Ra} + 1$
ADDIC Rd,Ra,Imm	001010	Rd	Ra	Imm		$Rd := s(Imm) + Ra + C$
RSUBIC Rd,Ra,Imm	001011	Rd	Ra	Imm		$Rd := s(Imm) + \overline{Ra} + C$
ADDIK Rd,Ra,Imm	001100	Rd	Ra	Imm		$Rd := s(Imm) + Ra$
RSUBIK Rd,Ra,Imm	001101	Rd	Ra	Imm		$Rd := s(Imm) + \overline{Ra} + 1$
ADDIKC Rd,Ra,Imm	001110	Rd	Ra	Imm		$Rd := s(Imm) + Ra + C$
RSUBIKC Rd,Ra,Imm	001111	Rd	Ra	Imm		$Rd := s(Imm) + \overline{Ra} + C$
MUL Rd,Ra,Rb	010000	Rd	Ra	Rb	00000000000	$Rd := Ra * Rb$

Table 7: MicroBlaze Instruction Set Summary (cont'd)

Type A	0-5	6-10	11-15	16-20	21-31	Semantics
Type B	0-5	6-10	11-15	16-31		
MULH Rd,Ra,Rb	010000	Rd	Ra	Rb	0000000001	Rd := (Ra * Rb) >> 32 (signed)
MULHU Rd,Ra,Rb	010000	Rd	Ra	Rb	0000000011	Rd := (Ra * Rb) >> 32 (unsigned)
MULHSU Rd,Ra,Rb	010000	Rd	Ra	Rb	0000000010	Rd := (Ra, signed * Rb, unsigned) >> 32 (signed)
BSRL Rd,Ra,Rb	010001	Rd	Ra	Rb	00L0000000	Rd := 0 & (Ra >> Rb)
BSRA Rd,Ra,Rb	010001	Rd	Ra	Rb	01L0000000	Rd := s(Ra >> Rb)
BSLL Rd,Ra,Rb	010001	Rd	Ra	Rb	10L0000000	Rd := (Ra << Rb) & 0
IDIV Rd,Ra,Rb	010010	Rd	Ra	Rb	0000000000	Rd := Rb/Ra
IDIVU Rd,Ra,Rb	010010	Rd	Ra	Rb	0000000010	Rd := Rb/Ra, unsigned
TNEAGETD Rd,Rb	010011	Rd	00000	Rb	0N0TAE 00000	Rd := FSL Rb[28:31] (data read) MSR[FSL] := 1 if (FSL_S_Control = 1) MSR[C] := not FSL_S_Exists if N = 1
TNAPUTD Ra,Rb	010011	00000	Ra	Rb	1N0TA0 00000	FSL Rb[28:31] := Ra (data write) MSR[C] := FSL_M_Full if N = 1
TNECAGETD Rd,Rb	010011	Rd	00000	Rb	0N1TAE 00000	Rd := FSL Rb[28:31] (control read) MSR[FSL] := 1 if (FSL_S_Control = 0) MSR[C] := not FSL_S_Exists if N = 1
TNCAPUTD Ra,Rb	010011	00000	Ra	Rb	1N1TA0 00000	FSL Rb[28:31] := Ra (control write) MSR[C] := FSL_M_Full if N = 1
FADD Rd,Ra,Rb	010110	Rd	Ra	Rb	0000000000	Rd := Rb+Ra, float ¹
FRSUB Rd,Ra,Rb	010110	Rd	Ra	Rb	0001000000	Rd := Rb-Ra, float ¹
FMUL Rd,Ra,Rb	010110	Rd	Ra	Rb	0010000000	Rd := Rb*Ra, float ¹
FDIV Rd,Ra,Rb	010110	Rd	Ra	Rb	0011000000	Rd := Rb/Ra, float ¹
FCMP.UN Rd,Ra,Rb	010110	Rd	Ra	Rb	0100000000	Rd := 1 if (Rb = NaN or Ra = NaN, float ¹) else Rd := 0
FCMP.LT Rd,Ra,Rb	010110	Rd	Ra	Rb	0100001000	Rd := 1 if (Rb < Ra, float ¹) else Rd := 0
FCMP.EQ Rd,Ra,Rb	010110	Rd	Ra	Rb	0100010000	Rd := 1 if (Rb = Ra, float ¹) else Rd := 0
FCMP.LE Rd,Ra,Rb	010110	Rd	Ra	Rb	0100011000	Rd := 1 if (Rb <= Ra, float ¹) else Rd := 0
FCMP.GT Rd,Ra,Rb	010110	Rd	Ra	Rb	0100100000	Rd := 1 if (Rb > Ra, float ¹) else Rd := 0
FCMP.NE Rd,Ra,Rb	010110	Rd	Ra	Rb	0100101000	Rd := 1 if (Rb != Ra, float ¹) else Rd := 0

Table 7: MicroBlaze Instruction Set Summary (cont'd)

Type A	0-5	6-10	11-15	16-20	21-31	Semantics
Type B	0-5	6-10	11-15	16-31		
FCMP.GE Rd,Ra,Rb	010110	Rd	Ra	Rb	01001100000	Rd := 1 if (Rb >= Ra, float ¹) else Rd := 0
FLT Rd,Ra	010110	Rd	Ra	0	01010000000	Rd := float (Ra) ¹
FINT Rd,Ra	010110	Rd	Ra	0	01100000000	Rd := int (Ra) ¹
FSQRT Rd,Ra	010110	Rd	Ra	0	01110000000	Rd := sqrt (Ra) ¹
DADD Rd,Ra,Rb ²	010110	Rd	Ra	Rb	10000000000	Rd := Rb+Ra, double ¹
DRSUB Rd,Ra,Rb ²	010110	Rd	Ra	Rb	10010000000	Rd := Rb-Ra, double ¹
DMUL Rd,Ra,Rb ²	010110	Rd	Ra	Rb	10100000000	Rd := Rb*Ra, double ¹
DDIV Rd,Ra,Rb ²	010110	Rd	Ra	Rb	10110000000	Rd := Rb/Ra, double ¹
DCMP.UN Rd,Ra,Rb ²	010110	Rd	Ra	Rb	11000000000	Rd := 1 if (Rb = NaN or Ra = NaN, double ¹) else Rd := 0
DCMP.LT Rd,Ra,Rb ²	010110	Rd	Ra	Rb	11000010000	Rd := 1 if (Rb < Ra, double ¹) else Rd := 0
DCMP.EQ Rd,Ra,Rb ²	010110	Rd	Ra	Rb	11000100000	Rd := 1 if (Rb = Ra, double ¹) else Rd := 0
DCMP.LE Rd,Ra,Rb ²	010110	Rd	Ra	Rb	11000110000	Rd := 1 if (Rb <= Ra, double ¹) else Rd := 0
DCMP.GT Rd,Ra,Rb ²	010110	Rd	Ra	Rb	11001000000	Rd := 1 if (Rb > Ra, double ¹) else Rd := 0
DCMP.NE Rd,Ra,Rb ²	010110	Rd	Ra	Rb	11001010000	Rd := 1 if (Rb != Ra, double ¹) else Rd := 0
DCMP.GE Rd,Ra,Rb ²	010110	Rd	Ra	Rb	11001100000	Rd := 1 if (Rb >= Ra, double ¹) else Rd := 0
DBL Rd,Ra ²	010110	Rd	Ra	0	11010000000	Rd := double (Ra) ¹
DLONG Rd,Ra ²	010110	Rd	Ra	0	11100000000	Rd := long (Ra) ¹
DSQRT Rd,Ra ²	010110	Rd	Ra	0	11110000000	Rd := dsqrt (Ra) ¹
MULI Rd,Ra,Imm	011000	Rd	Ra	Imm		Rd := Ra * s(Imm)
BSRLI Rd,Ra,Imm	011001	Rd	Ra	00L00000000 & Imm5		Rd := 0 & (Ra >> Imm5)
BSRAI Rd,Ra,Imm	011001	Rd	Ra	00L00010000 & Imm5		Rd := s(Ra >> Imm5)
BSLLI Rd,Ra,Imm	011001	Rd	Ra	00L00100000 & Imm5		Rd := (Ra << Imm5) & 0
BSEFI Rd,Ra, Imm _W ,Imm _S	011001	Rd	Ra	01L00 & Imm _W & 0 & Imm _S		Rd[0:31-Imm _W] := 0 Rd[32-Imm _W :31] := (Ra >> Imm _S)
BSIFI Rd,Ra, Width,Imm _S	011001	Rd	Ra	10L00 & Imm _W & 0 & Imm _S		M := (0xffffffff << (Imm _W + 1)) xor (0xffffffff << Imm _S) Rd := ((Ra << Imm _S) and M) xor (Rd and \bar{M}) Imm _W := Imm _S + Width - 1

Table 7: MicroBlaze Instruction Set Summary (cont'd)

Type A	0-5	6-10	11-15	16-20	21-31	Semantics
Type B	0-5	6-10	11-15	16-31		
ADDLI Rd,Imm ²	011010	Rd	00000	Imm		Rd[0:63] := s(Imm) + Rd[0:63]
RSUBLI Rd,Imm ²	011010	Rd	00001	Imm		Rd[0:63] := s(Imm) + $\overline{\text{Rd}}[0:63]$
ADDLIC Rd,Imm ²	011010	Rd	00010	Imm		Rd[0:63] := s(Imm) + Rd[0:63] + C
RSUBLIC Rd,Imm ²	011010	Rd	00011	Imm		Rd[0:63] := s(Imm) + $\overline{\text{Rd}}[0:63]$ + C
ADDLIK Rd,Imm ²	011010	Rd	00100	Imm		Rd[0:63] := s(Imm) + Rd[0:63]
RSUBLIK Rd,Imm ²	011010	Rd	00101	Imm		Rd[0:63] := s(Imm) + $\overline{\text{Rd}}[0:63]$
ADDLIKC Rd,Imm ²	011010	Rd	00110	Imm		Rd[0:63] := s(Imm) + Rd[0:63] + C
RSUBLIKC Rd,Imm ²	011010	Rd	00111	Imm		Rd[0:63] := s(Imm) + $\overline{\text{Rd}}[0:63]$ + C
ORLI Rd,Imm ²	011010	Rd	10000	Imm		Rd[0:63] := s(Imm) or Rd[0:63]
ANDLI Rd,Imm ²	011010	Rd	10001	Imm		Rd[0:63] := s(Imm) and Rd[0:63]
XORLI Rd,Imm ²	011010	Rd	10010	Imm		Rd[0:63] := s(Imm) xor Rd[0:63]
ANDNLI Rd,Imm ²	011010	Rd	10011	Imm		Rd[0:63] := s(Imm) and $\overline{\text{Rd}}[0:63]$
TNEAGET Rd,FSLx	011011	Rd	00000	0N07AE000000 & FSLx		Rd := FSLx (data read, blocking if N = 0) MSR[FSL] := 1 if (FSLx_S_Control = 1) MSR[C] := not FSLx_S_Exists if N = 1
TNAPUT Ra,FSLx	011011	00000	Ra	1N07AE000000 & FSLx		FSLx := Ra (data write, block if N = 0) MSR[C] := FSLx_M_Full if N = 1
TNECAGET Rd,FSLx	011011	Rd	00000	0N17AE000000 & FSLx		Rd := FSLx (control read, block if N = 0) MSR[FSL] := 1 if (FSLx_S_Control = 0) MSR[C] := not FSLx_S_Exists if N = 1
TNCAPUT Ra,FSLx	011011	00000	Ra	1N17AE000000 & FSLx		FSLx := Ra (control write, block if N = 0) MSR[C] := FSLx_M_Full if N = 1
OR Rd,Ra,Rb	100000	Rd	Ra	Rb	00000000000	Rd := Ra or Rb
PCMPBF Rd,Ra,Rb	100000	Rd	Ra	Rb	10000000000	Rd := 1 if (Rb[0:7] = Ra[0:7]) else Rd := 2 if (Rb[8:15] = Ra[8:15]) else Rd := 3 if (Rb[16:23] = Ra[16:23]) else Rd := 4 if (Rb[24:31] = Ra[24:31]) else Rd := 0
AND Rd,Ra,Rb	100001	Rd	Ra	Rb	00000000000	Rd := Ra and Rb
XOR Rd,Ra,Rb	100010	Rd	Ra	Rb	00000000000	Rd := Ra xor Rb

Table 7: MicroBlaze Instruction Set Summary (cont'd)

Type A	0-5	6-10	11-15	16-20	21-31	Semantics
Type B	0-5	6-10	11-15	16-31		
PCMPEQ Rd,Ra,Rb	100010	Rd	Ra	Rb	10000000000	Rd := 1 if (Rb = Ra) else Rd := 0
ANDN Rd,Ra,Rb	100011	Rd	Ra	Rb	00000000000	Rd := Ra and \bar{Rb}
PCMPNE Rd,Ra,Rb	100011	Rd	Ra	Rb	10000000000	Rd := 1 if (Rb != Ra) else Rd := 0
SRA Rd,Ra	100100	Rd	Ra	0000000000000001		Rd := s(Ra >> 1) C := Ra[31]
SRC Rd,Ra	100100	Rd	Ra	0000000000100001		Rd := C & (Ra >> 1) C := Ra[31]
SRL Rd,Ra	100100	Rd	Ra	0000000001000001		Rd := 0 & (Ra >> 1) C := Ra[31]
SEXT8 Rd,Ra	100100	Rd	Ra	0000000001100000		Rd := s(Ra[24:31])
SEXT16 Rd,Ra	100100	Rd	Ra	0000000001100001		Rd := s(Ra[16:31])
SEXTL32 Rd,Ra ²	100100	Rd	Ra	0000000001100010		Rd := s(Ra[32:63])
CLZ Rd, Ra	100100	Rd	Ra	0000000011100000		Rd = clz(Ra)
SWAPB Rd, Ra	100100	Rd	Ra	0000000111100000		Rd = (Ra)[24:31, 16:23, 8:15, 0:7]
SWAPH Rd, Ra	100100	Rd	Ra	0000000111100010		Rd = (Ra)[16:31, 0:15]
WIC Ra,Rb	100100	00000	Ra	Rb	00001101000	ICache_Line[Ra >> 4].Tag := 0 if (C_ICACHE_LINE_LEN = 4) ICache_Line[Ra >> 5].Tag := 0 if (C_ICACHE_LINE_LEN = 8) ICache_Line[Ra >> 6].Tag := 0 if (C_ICACHE_LINE_LEN = 16)
WDC Ra,Rb	100100	00000	Ra	Rb	00001100100	Cache line is cleared, discarding stored data. DCache_Line[Ra >> 4].Tag := 0 if (C_DCACHE_LINE_LEN = 4) DCache_Line[Ra >> 5].Tag := 0 if (C_DCACHE_LINE_LEN = 8) DCache_Line[Ra >> 6].Tag := 0 if (C_DCACHE_LINE_LEN = 16)
WDC.FLUSH Ra,Rb	100100	00000	Ra	Rb	00001110100	Cache line is flushed, writing stored data to memory, and then cleared. Used when C_DCACHE_USE_WRITEBACK = 1.
WDC.CLEAR Ra,Rb	100100	00000	Ra	Rb	00001100110	Cache line with matching address is cleared, discarding stored data. Used when C_DCACHE_USE_WRITEBACK = 1.

Table 7: MicroBlaze Instruction Set Summary (cont'd)

Type A	0-5	6-10	11-15	16-20	21-31	Semantics
Type B	0-5	6-10	11-15	16-31		
WDC.CLEAR.EA Ra,Rb	100100	00000	Ra	Rb	00011100110	Cache line with matching extended address Ra & Rb is cleared. Used when C_DCCACHE_USE_WRITEBACK = 1.
MTS Sd,Ra	100101	00000	Ra	11 & Sd		SPR[Sd] := Ra, where: <ul style="list-style-type: none"> SPR[0x0001] is MSR SPR[0x0007] is FSR SPR[0x0800] is SLR SPR[0x0802] is SHR SPR[0x1000] is PID SPR[0x1001] is ZPR SPR[0x1002] is TLBX SPR[0x1003] is TLBLO[LSH] SPR[0x1004] is TLBHI SPR[0x1005] is TLBSX
MTSE Sd,Ra	100101	01000	Ra	11 & Sd		SPR[Sd] := Ra, where: <ul style="list-style-type: none"> SPR[0x1003] is TLBLO[MSH]
MFS Rd,Sa	100101	Rd	00000	10 & Sa		Rd := SPR[Sa], where: <ul style="list-style-type: none"> SPR[0x0000] is PC SPR[0x0001] is MSR SPR[0x0003] is EAR[LSH] SPR[0x0005] is ESR SPR[0x0007] is FSR SPR[0x000B] is BTR SPR[0x000D] is EDR SPR[0x0800] is SLR SPR[0x0802] is SHR SPR[0x1000] is PID SPR[0x1001] is ZPR SPR[0x1002] is TLBX SPR[0x1003] is TLBLO[LSH] SPR[0x1004] is TLBHI SPR[0x2000-200B] is PVR[0-12][LSH]
MFSE Rd,Sa	100101	Rd	01000	10 & Sa		Rd := SPR[Sa][MSH], where: <ul style="list-style-type: none"> SPR[0x0003] is EAR[MSH] SPR[0x1003] is TLBLO[MSH] SPR[0x2006-2009] is PVR[6-9][MSH]
MSRCLR Rd,Imm	100101	Rd	10001	0 & Imm15		Rd := MSR MSR := MSR and $\overline{\text{Imm15}}$

Table 7: MicroBlaze Instruction Set Summary (cont'd)

Type A	0-5	6-10	11-15	16-20	21-31	Semantics
Type B	0-5	6-10	11-15	16-31		
MSRSET Rd,Imm	100101	Rd	10000	0 & Imm15		Rd := MSR MSR := MSR or Imm15
BR Rb	100110	00000	00000	Rb	00000000000	PC := PC + Rb
BRD Rb	100110	00000	10000	Rb	00000000000	PC := PC + Rb
BRLD Rd,Rb	100110	Rd	10100	Rb	00000000000	PC := PC + Rb Rd := PC
BRA Rb	100110	00000	01000	Rb	00000000000	PC := Rb
BRAD Rb	100110	00000	11000	Rb	00000000000	PC := Rb
BRALD Rd,Rb	100110	Rd	11100	Rb	00000000000	PC := Rb Rd := PC
BRK Rd,Rb	100110	Rd	01100	Rb	00000000000	PC := Rb Rd := PC MSR[BIP] := 1
BEQ Ra,Rb	100111	0L000	Ra	Rb	00000000000	PC := PC + Rb if Ra = 0
BNE Ra,Rb	100111	0L001	Ra	Rb	00000000000	PC := PC + Rb if Ra != 0
BLT Ra,Rb	100111	0L010	Ra	Rb	00000000000	PC := PC + Rb if Ra < 0
BLE Ra,Rb	100111	0L011	Ra	Rb	00000000000	PC := PC + Rb if Ra <= 0
BGT Ra,Rb	100111	0L100	Ra	Rb	00000000000	PC := PC + Rb if Ra > 0
BGE Ra,Rb	100111	0L101	Ra	Rb	00000000000	PC := PC + Rb if Ra >= 0
BEQD Ra,Rb	100111	1L000	Ra	Rb	00000000000	PC := PC + Rb if Ra = 0
BNED Ra,Rb	100111	1L001	Ra	Rb	00000000000	PC := PC + Rb if Ra != 0
BLTD Ra,Rb	100111	1L010	Ra	Rb	00000000000	PC := PC + Rb if Ra < 0
BLED Ra,Rb	100111	1L011	Ra	Rb	00000000000	PC := PC + Rb if Ra <= 0
BGTD Ra,Rb	100111	1L100	Ra	Rb	00000000000	PC := PC + Rb if Ra > 0
BGED Ra,Rb	100111	1L101	Ra	Rb	00000000000	PC := PC + Rb if Ra >= 0
ORI Rd,Ra,Imm	101000	Rd	Ra	Imm		Rd := Ra or s(Imm)
ANDI Rd,Ra,Imm	101001	Rd	Ra	Imm		Rd := Ra and s(Imm)
XORI Rd,Ra,Imm	101010	Rd	Ra	Imm		Rd := Ra xor s(Imm)
ANDNI Rd,Ra,Imm	101011	Rd	Ra	Imm		Rd := Ra and $\overline{s(Imm)}$
IMM Imm	101100	00000	00000	Imm		Imm[0:15] := Imm
IMML Imm24 ²	101100	10	Imm24			Imm[24:47] := Imm24
RTSD Ra,Imm	101101	10000	Ra	Imm		PC := Ra + s(Imm)
RTID Ra,Imm	101101	10001	Ra	Imm		PC := Ra + s(Imm) MSR[IE] := 1
RTBD Ra,Imm	101101	10010	Ra	Imm		PC := Ra + s(Imm) MSR[BIP] := 0
RTED Ra,Imm	101101	10100	Ra	Imm		PC := Ra + s(Imm) MSR[EE] := 1, MSR[EIP] := 0 ESR := 0

Table 7: MicroBlaze Instruction Set Summary (cont'd)

Type A	0-5	6-10	11-15	16-20	21-31	Semantics
Type B	0-5	6-10	11-15	16-31		
BRI Imm	101110	00000	00000	Imm		PC := PC + s(Imm)
MBAR Imm	101110	Imm	00010	0000000000000100		PC := PC + 4; Wait for memory accesses.
BRID Imm	101110	00000	10000	Imm		PC := PC + s(Imm)
BRLID Rd,Imm	101110	Rd	10100	Imm		PC := PC + s(Imm) Rd := PC
BRAI Imm	101110	00000	01000	Imm		PC := s(Imm)
BRAID Imm	101110	00000	11000	Imm		PC := s(Imm)
BRALID Rd,Imm	101110	Rd	11100	Imm		PC := s(Imm) Rd := PC
BRKI Rd,Imm	101110	Rd	01100	Imm		PC := s(Imm) Rd := PC MSR[BIP] := 1
BEQI Ra,Imm	101111	0L000	Ra	Imm		PC := PC + s(Imm) if Ra = 0
BNEI Ra,Imm	101111	0L001	Ra	Imm		PC := PC + s(Imm) if Ra != 0
BLTI Ra,Imm	101111	0L010	Ra	Imm		PC := PC + s(Imm) if Ra < 0
BLEI Ra,Imm	101111	0L011	Ra	Imm		PC := PC + s(Imm) if Ra <= 0
BGTI Ra,Imm	101111	0L100	Ra	Imm		PC := PC + s(Imm) if Ra > 0
BGEI Ra,Imm	101111	0L101	Ra	Imm		PC := PC + s(Imm) if Ra >= 0
BEQID Ra,Imm	101111	1L000	Ra	Imm		PC := PC + s(Imm) if Ra = 0
BNEID Ra,Imm	101111	1L001	Ra	Imm		PC := PC + s(Imm) if Ra != 0
BLTID Ra,Imm	101111	1L010	Ra	Imm		PC := PC + s(Imm) if Ra < 0
BLEID Ra,Imm	101111	1L011	Ra	Imm		PC := PC + s(Imm) if Ra <= 0
BGTID Ra,Imm	101111	1L100	Ra	Imm		PC := PC + s(Imm) if Ra > 0
BGEID Ra,Imm	101111	1L101	Ra	Imm		PC := PC + s(Imm) if Ra >= 0
LBU Rd,Ra,Rb LBUR Rd,Ra,Rb	110000	Rd	Ra	Rb	0000000000 0100000000	Addr := Ra + Rb Rd[0:23] := 0 Rd[24:31] := *Addr[0:7]
LBUEA Rd,Ra,Rb	110000	Rd	Ra	Rb	0001000000	Addr := Ra & Rb Rd[0:23] := 0 Rd[24:31] := *Addr[0:7]
LHU Rd,Ra,Rb LHUR Rd,Ra,Rb	110001	Rd	Ra	Rb	0000000000 0100000000	Addr := Ra + Rb Rd[0:15] := 0 Rd[16:31] := *Addr[0:15]
LHUEA Rd,Ra,Rb	110001	Rd	Ra	Rb	0001000000	Addr := Ra & Rb Rd[0:15] := 0 Rd[16:31] := *Addr[0:15]
LW Rd,Ra,Rb LWR Rd,Ra,Rb	110010	Rd	Ra	Rb	0000000000 0100000000	Addr := Ra + Rb Rd := *Addr

Table 7: MicroBlaze Instruction Set Summary (cont'd)

Type A	0-5	6-10	11-15	16-20	21-31	Semantics
Type B	0-5	6-10	11-15	16-31		
LWX Rd,Ra,Rb	110010	Rd	Ra	Rb	1000000000	Addr := Ra + Rb Rd := *Addr Reservation := 1
LWEA Rd,Ra,Rb	110010	Rd	Ra	Rb	0001000000	Addr := Ra & Rb Rd := *Addr
LL Rd,Ra,Rb ² LLR Rd,Ra,Rb ²	110010	Rd	Ra	Rb	0010000000 0110000000	Addr := Ra[0:63] + Rb[0:63] Rd[0:63] := *Addr[0:63]
SB Rd,Ra,Rb SBR Rd,Ra,Rb	110100	Rd	Ra	Rb	0000000000 0100000000	Addr := Ra + Rb *Addr[0:8] := Rd[24:31]
SBEA Rd,Ra,Rb	110100	Rd	Ra	Rb	0001000000	Addr := Ra & Rb *Addr[0:8] := Rd[24:31]
SH Rd,Ra,Rb SHR Rd,Ra,Rb	110101	Rd	Ra	Rb	0000000000 0100000000	Addr := Ra + Rb *Addr[0:16] := Rd[16:31]
SHEA Rd,Ra,Rb	110101	Rd	Ra	Rb	0001000000	Addr := Ra & Rb *Addr[0:16] := Rd[16:31]
SW Rd,Ra,Rb SWR Rd,Ra,Rb	110110	Rd	Ra	Rb	0000000000 0100000000	Addr := Ra + Rb *Addr := Rd
SWX Rd,Ra,Rb	110110	Rd	Ra	Rb	1000000000	Addr := Ra + Rb *Addr := Rd if Reservation = 1 Reservation := 0
SWEA Rd,Ra,Rb	110110	Rd	Ra	Rb	0001000000	Addr := Ra & Rb *Addr := Rd
SL Rd,Ra,Rb ² SLR Rd,Ra,Rb ²	110110	Rd	Ra	Rb	0010000000 0110000000	Addr := Ra[0:63] + Rb[0:63] *Addr[0:63] := Rd[0:63]
LBUI Rd,Ra,Imm	111000	Rd	Ra	Imm		Addr := Ra + s(Imm) Rd[0:23] := 0 Rd[24:31] := *Addr[0:7]
LHUI Rd,Ra,Imm	111001	Rd	Ra	Imm		Addr := Ra + s(Imm) Rd[0:15] := 0 Rd[16:31] := *Addr[0:15]
LWI Rd,Ra,Imm	111010	Rd	Ra	Imm		Addr := Ra + s(Imm) Rd := *Addr
LLI Rd,Ra,Imm ²	111011	Rd	Ra	Imm		Addr := Ra[0:63] + s(Imm) Rd[0:63] := *Addr[0:63]
SBI Rd,Ra,Imm	111100	Rd	Ra	Imm		Addr := Ra + s(Imm) *Addr[0:7] := Rd[24:31]
SHI Rd,Ra,Imm	111101	Rd	Ra	Imm		Addr := Ra + s(Imm) *Addr[0:15] := Rd[16:31]
SWI Rd,Ra,Imm	111110	Rd	Ra	Imm		Addr := Ra + s(Imm) *Addr := Rd

Table 7: MicroBlaze Instruction Set Summary (cont'd)

Type A	0-5	6-10	11-15	16-20	21-31	Semantics
Type B	0-5	6-10	11-15	16-31		
SLI Rd,Ra,Imm ²	111111	Rd	Ra	Imm		Addr := Ra[0:63] + s(Imm) *Addr[0:63] := Rd[0:63]

Notes:

1. Due to the many different corner cases involved in floating-point arithmetic, only the normal behavior is described. A full description of the behavior can be found in [Chapter 5: MicroBlaze Instruction Set Architecture](#).
2. Only available with 64-bit MicroBlaze.

Semaphore Synchronization

The LWX and SWX instructions are used to implement common semaphore operations, including test and set, compare and swap, exchange memory, and fetch and add. They are also used to implement spinlocks.

These instructions are typically used by system programs and are called by application programs as needed.

Generally, a program uses LWX to load a semaphore from memory, causing the reservation to be set (the processor maintains the reservation internally). The program can compute a result based on the semaphore value and conditionally store the result back to the same memory location using the SWX instruction. The conditional store is performed based on the existence of the reservation established by the preceding LWX instruction. If the reservation exists when the store is executed, the store is performed and MSR[C] is cleared to 0. If the reservation does not exist when the store is executed, the target memory location is not modified and MSR[C] is set to 1.

If the store is successful, the sequence of instructions from the semaphore load to the semaphore store appear to be executed atomically—no other device modified the semaphore location between the read and the update. Other devices can read from the semaphore location during the operation.

For a semaphore operation to work properly, the LWX instruction must be paired with an SWX instruction, and both must specify identical addresses.

The reservation granularity in MicroBlaze is a word. For both instructions, the address must be word aligned. No unaligned exceptions are generated for these instructions.

The conditional store is always attempted when a reservation exists, even if the store address does not match the load address that set the reservation.

Only one reservation can be maintained at a time. The address associated with the reservation can be changed by executing a subsequent LWX instruction.

The conditional store is performed based upon the reservation established by the last LWX instruction executed. Executing an SWX instruction always clears a reservation held by the processor, whether the address matches that established by the LWX or not.

Reset, interrupts, exceptions, and breaks (including the BRK and BRKI instructions) all clear the reservation.

The following provides general guidelines for using the LWX and SWX instructions:

- The LWX and SWX instructions should be paired and use the same address.
- An unpaired SWX instruction to an arbitrary address can be used to clear any reservation held by the processor.
- A conditional sequence begins with an LWX instruction. It can be followed by memory accesses and/or computations on the loaded value. The sequence ends with an SWX instruction. In most cases, failure of the SWX instruction should cause a branch back to the LWX for a repeated attempt.
- An LWX instruction can be left unpaired when executing certain synchronization primitives if the value loaded by the LWX is not zero. An implementation of Test and Set exemplifies this:

```

loop:      lwx          r5,r3,r0    ; load and reserve
          bnei         r5,next     ; branch if not equal to zero
          addik        r5,r5,1     ; increment value
          swx          r5,r3,r0    ; try to store non-zero value
          addic        r5,r0,0     ; check reservation
          bnei         r5,loop     ; loop if reservation lost
next:

```

- Performance can be improved by minimizing looping on an LWX instruction that fails to return a desired value. Performance can also be improved by using an ordinary load instruction to do the initial value check. An implementation of a spinlock exemplifies this:

```

loop:      lw          r5,r3,r0    ; load the word
          bnei         r5,loop     ; loop back if word not equal to 0
          lwx         r5,r3,r0    ; try reserving again
          bnei         r5,loop     ; likely that no branch is needed
          addik        r5,r5,1     ; increment value
          swx         r5,r3,r0    ; try to store non-zero value
          addic        r5,r0,0     ; check reservation
          bnei         r5,loop     ; loop if reservation lost

```

- Minimizing the looping on an LWX/SWX instruction pair increases the likelihood that forward progress is made. The old value should be tested before attempting the store. If the order is reversed (store before load), more SWX instructions are executed and reservations are more likely to be lost between the LWX and SWX instructions.

Self-Modifying Code

When using self-modifying code software must ensure that the modified instructions have been written to memory prior to fetching them for execution. There are several aspects to consider:

- The instructions to be modified could already have been fetched prior to modification:
 - Into the instruction prefetch buffer
 - Into the instruction cache, if it is enabled
 - Into a stream buffer, if instruction cache stream buffers are used
 - Into the instruction cache, and then saved in a victim buffer, if victim buffers are used.

To ensure that the modified code is always executed instead of the old unmodified code, software must handle all these cases.

- If one or more of the instructions to be modified is a branch, and the branch target cache is used, the branch target address might have been cached.

To avoid using the cached branch target address, software must ensure that the branch target cache is cleared prior to executing the modified code.

- The modified instructions might not have been written to memory prior to execution:
 - They might be en-route to memory, in temporary storage in the interconnect or the memory controller.
 - They might be stored in the data cache, if write-back cache is used.
 - They might be saved in a victim buffer, if write-back cache and victim buffers are used.

Software must ensure that the modified instructions have been written to memory before being fetched by the processor.

The annotated code below shows how each of the above issues can be addressed. This code assumes that both instruction cache and write-back data cache is used. If not, the corresponding instructions can be omitted.

The following code exemplifies storing a modified instruction:

```
swi          r5,r6,0 ; r5 = new instruction
              ; r6 = physical instruction address
wdc.flush   r6,r0 ; flush write-back data cache line
mbar        1 ; ensure new instruction is written to memory
wic         r7,r0 ; invalidate line, empty stream & victim buffers
              ; r7 = virtual instruction address
mbar        2 ; empty prefetch buffer, clear branch target cache
```

The physical and virtual addresses above are identical, unless MMU virtual mode is used. If the MMU is enabled, the code sequences must be executed in real mode, because WIC and WDC are privileged instructions. The first instruction after the code sequences above must not be modified, because it might have been prefetched.

Registers

MicroBlaze has an orthogonal instruction set architecture. It has thirty-two 32-bit or 64-bit general purpose registers and up to sixteen special purpose registers, depending on configured options. The most significant bit of all registers is denoted as bit 0.

General Purpose Registers

The thirty-two 32-bit or 64-bit General Purpose Registers are numbered R0 through R31. The register file is reset on bit stream download (reset value is 0x00000000). The following figure is a representation of a General Purpose Register and the following table provides a description of each register and the register reset value (if existing).

When 64-bit MicroBlaze is enabled (`C_DATA_SIZE = 64`), the General Purpose Registers have 64 bits, otherwise they have 32 bits.

Note: The register file is not reset by the external reset inputs: `Reset` and `Debug_Rst`.

Figure 2: R0-R31

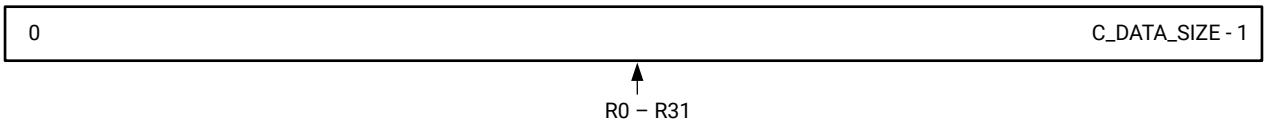

X19739-111417

Table 8: General Purpose Registers (R0-R31)

Bits ¹	Name	Description	Reset Value
0:63	R0	Always has a value of zero. Anything written to R0 is discarded	0x0
0:31	R1 through R13	General purpose registers	-
	R14	Register used to store return addresses for interrupts.	-
	R15	General purpose register. Recommended for storing return addresses for user vectors.	-
	R16	Register used to store return addresses for breaks.	-
	R17	If MicroBlaze is configured to support hardware exceptions, this register is loaded with the address of the instruction following the instruction causing the HW exception, except for exceptions in delay slots that use BTR instead (see Branch Target Register); if not, it is a general purpose register.	-
	R18 through R31	General purpose registers.	-

Notes:

1. 64 bits with 64-bit MicroBlaze (`C_DATA_SIZE = 64`) and 32 bits otherwise.

See (Table 92: Register Usage Conventions) for software conventions on general purpose register usage.

Special Purpose Registers

Program Counter

The program counter (PC) is the address of the execution instruction. It can be read with an MFS instruction, but it cannot be written with an MTS instruction. When used with the MFS instruction the PC register is specified by setting Sa = 0x0000. The following figure illustrates the PC and the following table provides a description and reset value.

When 64-bit MicroBlaze is enabled (C_DATA_SIZE = 64), the Program Counter has up to 64 bits, according to the C_ADDR_SIZE parameter, otherwise it has 32 bits.

Figure 3: PC

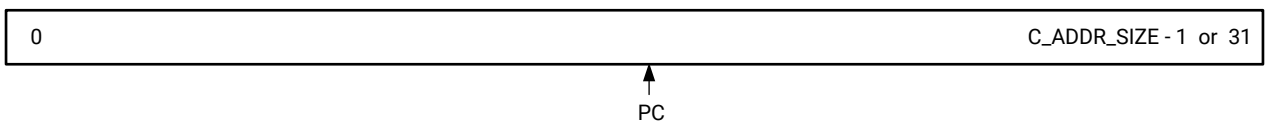

X19740-111417

Table 9: Program Counter (PC)

Bits ¹	Name	Description	Reset Value
0:31 0:C_ADDR_SIZE-1	PC	Program Counter Address of executing instruction, that is, "mfs r2 0" stores the address of the mfs instruction itself in R2.	C_BASE_VECTORS

Notes:

1. C_ADDR_SIZE bits with 64-bit MicroBlaze (C_DATA_SIZE = 64) and 32 bits otherwise.

Machine Status Register

The Machine Status Register (MSR) contains control and status bits for the processor. It can be read with an MFS instruction. When reading the MSR, the carry bit is replicated in the carry copy bit. MSR can be written using either an MTS instruction or the dedicated MSRSET and MSRCLR instructions.

When writing to the MSR using MSRSET or MSRCLR, the Carry bit takes effect immediately and the remaining bits take effect one clock cycle later. When writing using MTS, all bits take effect one clock cycle later. Any value written to the carry copy bit is discarded.

When used with an MTS or MFS instruction, the MSR is specified by setting Sx = 0x0001. The following figure illustrates the MSR register and the following table provides the bit description and reset values.

Figure 4: MSR

32-bit MicroBlaze: C_DATA_SIZE = 32

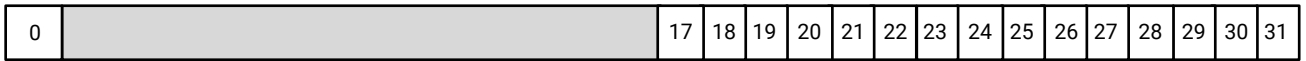

64-bit MicroBlaze: C_DATA_SIZE = 64

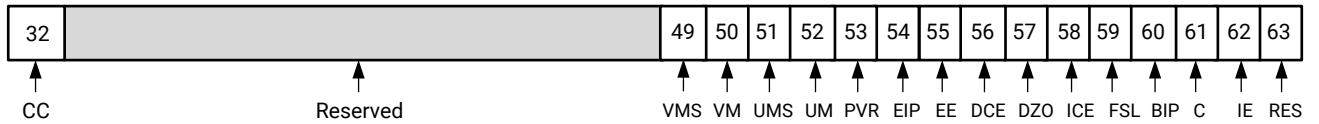

X19741-111517

Table 10: Machine Status Register (MSR)

Bits ¹	Name	Description	Reset Value
0, 32	CC	Arithmetic Carry Copy Copy of the Arithmetic Carry. CC is always the same as bit C.	0
1:16 2:48	Reserved		
17, 49	VMS	Virtual Protected Mode Save Only available when configured with an MMU (if C_USE_MMU > 1 and C_AREA_OPTIMIZED = 0 or 2) Read/Write	0
18, 50	VM	Virtual Protected Mode 0 = MMU address translation and access protection disabled, with C_USE_MMU = 3 (Virtual). Access protection disabled with C_USE_MMU = 2 (Protection) 1 = MMU address translation and access protection enabled, with C_USE_MMU = 3 (Virtual). Access protection enabled, with C_USE_MMU = 2 (Protection). Only available when configured with an MMU (if C_USE_MMU > 1 and C_AREA_OPTIMIZED = 0 or 2) Read/Write	0
19, 51	UMS	User Mode Save Only available when configured with an MMU (if C_USE_MMU > 0 and C_AREA_OPTIMIZED = 0 or 2) Read/Write	0
20, 52	UM	User Mode 0 = Privileged Mode, all instructions are allowed 1 = User Mode, certain instructions are not allowed Only available when configured with an MMU (if C_USE_MMU > 0 and C_AREA_OPTIMIZED = 0 or 2) Read/Write	0
21, 53	PVR	Processor Version Register exists 0 = No Processor Version Register 1 = Processor Version Register exists Read only	Based on parameter C_PVR

Table 10: Machine Status Register (MSR) (cont'd)

Bits ¹	Name	Description	Reset Value
22, 54	EIP	Exception In Progress 0 = No hardware exception in progress 1 = Hardware exception in progress Only available if configured with exception support (C*_EXCEPTION or C_USE_MMU > 0) Read/Write	0
23, 55	EE	Exception Enable 0 = Hardware exceptions disabled ² 1 = Hardware exceptions enabled Only available if configured with exception support (C*_EXCEPTION or C_USE_MMU > 0) Read/Write	0
24, 56	DCE	Data Cache Enable 0 = Data Cache disabled 1 = Data Cache enabled Only available if configured to use data cache (C_USE_DCACHE = 1) Read/Write	0
25, 57	DZO	Division by Zero or Division Overflow ³ 0 = No division by zero or division overflow has occurred 1 = Division by zero or division overflow has occurred Only available if configured to use hardware divider (C_USE_DIV = 1) Read/Write	0
26, 58	ICE	Instruction Cache Enable 0 = Instruction Cache disabled 1 = Instruction Cache enabled Only available if configured to use instruction cache (C_USE_ICACHE = 1) Read/Write	0
27, 59	FSL	AXI4-Stream Error 0 = get or getd had no error 1 = get or getd control type mismatch This bit is sticky, that is it is set by a get or getd instruction when a control bit mismatch occurs. To clear it an MTS or MSRCLR instruction must be used. Only available if configured to use stream links (C_FSL_LINKS > 0) Read/Write	0
28, 60	BIP	Break in Progress 0 = No Break in Progress 1 = Break in Progress Break Sources can be software break instruction or hardware break from Ext_Brk or Ext_NM_Brk pin. Read/Write	0

Table 10: Machine Status Register (MSR) (cont'd)

Bits ¹	Name	Description	Reset Value
29, 61	C	Arithmetic Carry 0 = No Carry (Borrow) 1 = Carry (No Borrow) Read/Write	0
30, 62	IE	Interrupt Enable 0 = Interrupts disabled 1 = Interrupts enabled Read/Write	0
31, 63	-	Reserved	0

Notes:

1. Bit numbers depend on if 64-bit MicroBlaze (C_DATA_SIZE = 64) is enabled or not.
2. The MMU exceptions (Data Storage Exception, Instruction Storage Exception, Data TLB Miss Exception, Instruction TLB Miss Exception) cannot be disabled, and are not affected by this bit.
3. This bit is only used for integer divide-by-zero or divide overflow signaling. There is a floating point equivalent in the FSR. The DZO-bit flags divide by zero or divide overflow conditions regardless if the processor is configured with exception handling or not.

Exception Address Register

The Exception Address Register (EAR) stores the full load/store address that caused the exception for the following:

- An unaligned access exception that specifies the unaligned access data address
- An M_AXI_DP exception that specifies the failing AXI4 data access address
- A data storage exception that specifies the (virtual) effective address accessed
- An instruction storage exception that specifies the (virtual) effective address read
- A data TLB miss exception that specifies the (virtual) effective address accessed
- An instruction TLB miss exception that specifies the (virtual) effective address read

The contents of this register are undefined for all other exceptions. When read with the MFS or MFSE instruction, the EAR is specified by setting Sa = 0x0003. The EAR register is illustrated in the following figure and the following table provides bit descriptions and reset values.

With 32-bit MicroBlaze (parameter C_DATA_SIZE = 32) and extended data addressing is enabled (parameter C_ADDR_SIZE > 32), the 32 least significant bits of the register are read with the MFS instruction, and the most significant bits with the MFSE instruction.

With 64-bit MicroBlaze (parameter C_DATA_SIZE = 64) the entire register can be read with the MFS instruction.

Figure 5: EAR

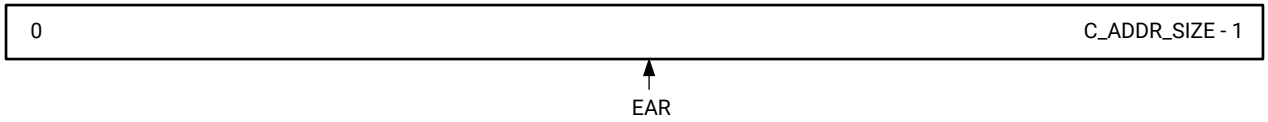

X19742-111517

Table 11: Exception Address Register (EAR)

Bits	Name	Description	Reset Value
0:C_ADDR_SIZE-1	EAR	Exception Address Register	0

Exception Status Register

The Exception Status Register (ESR) contains status bits for the processor. When read with the MFS instruction, the ESR is specified by setting Sa = 0x0005. The ESR register is illustrated in the following figure, the following table provides bit descriptions and reset values, and [Table 13: Exception Specific Status \(ESS\)](#) provides the Exception Specific Status (ESS).

Figure 6: ESR

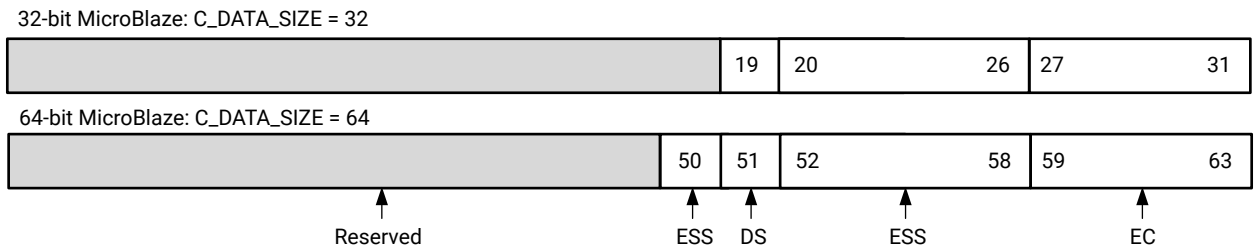

X19743-111517

Table 12: Exception Status Register (ESR)

Bits ¹	Name	Description	Reset Value
0:17 0:49	Reserved		
-, 50	ESS	Exception Specific Status, only available with 64-bit MicroBlaze (C_DATA_SIZE = 64), otherwise reserved. For details refer to Table 13: Exception Specific Status (ESS) . Read-only	See Table 13: Exception Specific Status (ESS)
19, 51	DS	Delay Slot Exception. 0 = not caused by delay slot instruction 1 = caused by delay slot instruction Read-only	0

Table 12: Exception Status Register (ESR) (cont'd)

Bits ¹	Name	Description	Reset Value
20:26 52:58	ESS	Exception Specific Status For details refer to Table 13: Exception Specific Status (ESS) . Read-only	See Table 13: Exception Specific Status (ESS)
27:31 59:63	EC	Exception Cause 00000 = Stream exception 00001 = Unaligned data access exception 00010 = Illegal op-code exception 00011 = Instruction bus error exception 00100 = Data bus error exception 00101 = Divide exception 00110 = Floating point unit exception 00111 = Privileged instruction exception 00111 = Stack protection violation exception 10000 = Data storage exception 10001 = Instruction storage exception 10010 = Data TLB miss exception 10011 = Instruction TLB miss exception Read-only	0

Notes:

1. Bit numbers depend on if 64-bit MicroBlaze (C_DATA_SIZE = 64) is enabled or not.

Table 13: Exception Specific Status (ESS)

Exception Cause	Bits ¹	Name	Description	Reset Value
Unaligned Data Access	-, 50	L	Long Access Exception 0 = unaligned word or halfword access 1 = unaligned long access	0
	20, 52	W	Word Access Exception 0 = unaligned halfword access 1 = unaligned word access	0
	21, 53	S	Store Access Exception 0 = unaligned load access 1 = unaligned store access	0
	22:26 54:58	Rx	Source/Destination Register General purpose register used as source (Store) or destination (Load) in unaligned access	0
Illegal Instruction	20:26 52:58	Reserved		0
Instruction bus error	20, 52	ECC	Exception caused by ILMB correctable or uncorrectable error	0
	21:26 53:58	Reserved		0

Table 13: Exception Specific Status (ESS) (cont'd)

Exception Cause	Bits ¹	Name	Description	Reset Value
Data bus error	20, 52	ECC	Exception caused by DLMB correctable or uncorrectable error	0
	21:26 53:58	Reserved		0
Divide	20, 52	DEC	Divide - Division exception cause 0 = Divide-By-Zero 1 = Division Overflow	0
	21:26 53:58	Reserved		0
Floating point unit	20:26 52:58	Reserved		0
Privileged instruction	20:26 52:58	Reserved		0
Stack protection violation	20:26 52:58	Reserved		0
Stream	20:22 52:54	Reserved		0
	23:26 55:58	FSL	AXI4-Stream index that caused the exception	0
Data storage	20, 52	DIZ	Data storage - Zone protection 0 = Did not occur 1 = Occurred	0
	21, 53	S	Data storage - Store instruction 0 = Did not occur 1 = Occurred	0
	22:26 54:58	Reserved		0
Instruction storage	20, 52	DIZ	Instruction storage - Zone protection 0 = Did not occur 1 = Occurred	0
	21:26 53:58	Reserved		0
Data TLB miss	20, 52	Reserved		0
	21, 53	S	Data TLB miss - Store instruction 0 = Did not occur 1 = Occurred	0
	22:26 54:58	Reserved		0
Instruction TLB miss	20:26 52:58	Reserved		0

Notes:

1. Bit numbers depend on if 64-bit MicroBlaze (C_DATA_SIZE = 64) is enabled or not.

Branch Target Register

The Branch Target Register (BTR) only exists if the MicroBlaze processor is configured to use exceptions. The register stores the branch target address for all delay slot branch instructions executed while MSR[EIP] = 0. If an exception is caused by an instruction in a delay slot (that is, ESR[DS]=1), the exception handler should return execution to the address stored in BTR instead of the normal exception return address stored in R17. When read with the MFS instruction, the BTR is specified by setting Sa = 0x000B. The BTR register is illustrated in the following figure and the following table provides bit descriptions and reset values.

When 64-bit MicroBlaze is enabled (C_DATA_SIZE = 64), the Branch Target Register has up to 64 bits, according to the C_ADDR_SIZE parameter, otherwise it has 32 bits.

Figure 7: BTR

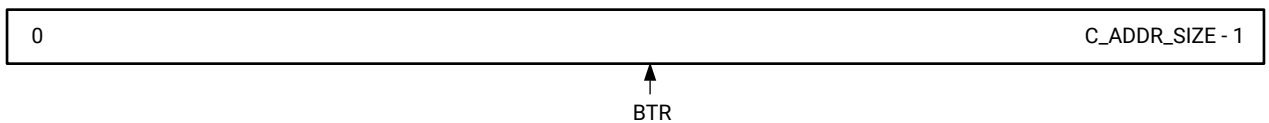

X19744-111517

Table 14: Branch Target Register (BTR)

Bits ¹	Name	Description	Reset Value
0:31 0:C_ADDR_SIZE-1	BTR	Branch target address used by handler when returning from an exception caused by an instruction in a delay slot. Read-only	0x0

Notes:

- C_ADDR_SIZE bits with 64-bit MicroBlaze (C_DATA_SIZE = 64) and 32 bits otherwise.

Floating-Point Status Register

The Floating-Point Status Register contains status bits for the floating-point unit. It can be read with an MFS, and written with an MTS instruction. When read or written, the register is specified by setting Sa = 0x0007. The bits in this register are sticky - floating-point instructions can only set bits in the register, and the only way to clear the register is by using the MTS instruction. The following figure illustrates the FSR register and the following table provides bit descriptions and reset values.

Figure 8: FSR

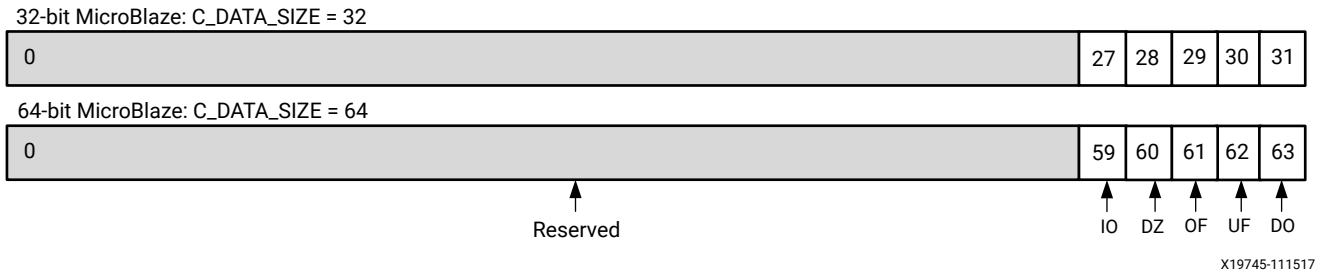

Table 15: Floating Point Status Register (FSR)

Bits ¹	Name	Description	Reset Value
0:26 0:58	Reserved		undefined
27, 59	IO	Invalid operation	0
28, 60	DZ	Divide-by-zero	0
29, 61	OF	Overflow	0
30, 62	UF	Underflow	0
31, 63	DO	Denormalized operand error	0

Notes:

1. Bit numbers depend on if 64-bit MicroBlaze (C_DATA_SIZE = 64) is enabled or not.

Exception Data Register

The Exception Data Register (EDR) stores data read on an AXI4-Stream link that caused a stream exception.

The contents of this register are undefined for all other exceptions. When read with the MFS instruction, the EDR is specified by setting Sa = 0x000D. The following figure illustrates the EDR register and the following table provides bit descriptions and reset values.

Note: The register is only implemented if C_FSL_LINKS is greater than 0 and C_FSL_EXCEPTION is set to 1.

Figure 9: EDR

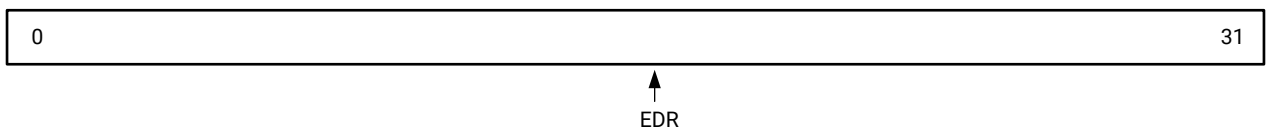

Table 16: Exception Data Register (EDR)

Bits	Name	Description	Reset Value
0:31	EDR	Exception Data Register	0x00000000

Stack Low Register

The Stack Low Register (SLR) stores the stack low limit use to detect stack overflow. When the address of a load or store instruction using the stack pointer (register R1) as rA is less than the Stack Low Register, a stack overflow occurs, causing a Stack Protection Violation exception if exceptions are enabled in MSR.

When read with the MFS instruction, the SLR is specified by setting Sa = 0x0800. The following figure illustrates the SLR register and the following table provides bit descriptions and reset values.

When 64-bit MicroBlaze is enabled (C_DATA_SIZE = 64), the Stack Low Register has up to 64 bits, according to the C_ADDR_SIZE parameter, otherwise it has 32 bits.

Note: The register is only implemented if stack protection is enabled by setting the parameter C_USE_STACK_PROTECTION to 1. If stack protection is not implemented, writing to the register has no effect.

Note: Stack protection is not available when the MMU is enabled (C_USE_MMU > 0). With the MMU page-based memory protection is provided through the UTLB instead.

Figure 10: SLR

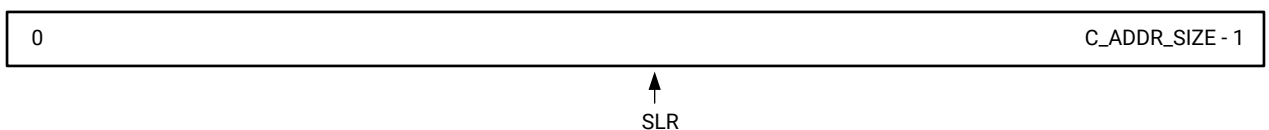

X19747-111517

Table 17: Stack Low Register (SLR)

Bits ¹	Name	Description	Reset Value
0:31 0:C_ADDR_SIZE-1	SLR	Stack Low Register	0x0

Notes:

1. C_ADDR_SIZE bits with 64-bit MicroBlaze (C_DATA_SIZE = 64) and 32 bits otherwise.

Stack High Register

The Stack High Register (SHR) stores the stack high limit use to detect stack underflow. When the address of a load or store instruction using the stack pointer (register R1) as rA is greater than the Stack High Register, a stack underflow occurs, causing a Stack Protection Violation exception if exceptions are enabled in MSR.

When read with the MFS instruction, the SHR is specified by setting Sa = 0x0802. The following figure illustrates the SHR register and the following table provides bit descriptions and reset values.

When 64-bit MicroBlaze is enabled (C_DATA_SIZE = 64), the Stack High Register has up to 64 bits, according to the C_ADDR_SIZE parameter, otherwise it has 32 bits.

Note: The register is only implemented if stack protection is enabled by setting the parameter C_USE_STACK_PROTECTION to 1. If stack protection is not implemented, writing to the register has no effect.

Note: Stack protection is not available when the MMU is enabled (C_USE_MMU > 0). With the MMU page-based memory protection is provided through the UTLB instead.

Figure 11: SHR

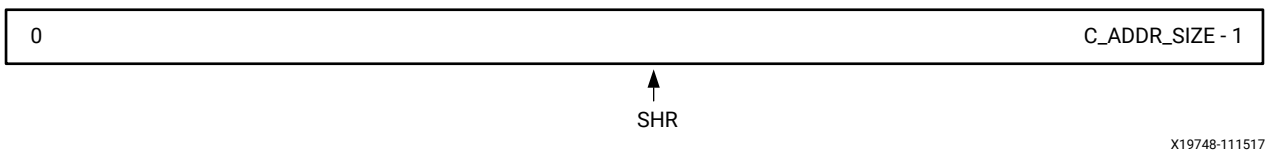

X19748-111517

Table 18: Stack High Register (SHR)

Bits ¹	Name	Description	Reset Value
0:31 0:C_ADDR_SIZE-1	SHR	Stack High Register	All bits set to 1

Notes:

1. C_ADDR_SIZE bits with 64-bit MicroBlaze (C_DATA_SIZE = 64) and 32 bits otherwise.

Process Identifier Register

The Process Identifier Register (PID) is used to uniquely identify a software process during MMU address translation. It is controlled by the C_USE_MMU configuration option on MicroBlaze. The register is only implemented if C_USE_MMU is greater than 1 (User Mode) and C_AREA_OPTIMIZED is set to 0 (Performance) or 2 (Frequency).

When accessed with the MFS and MTS instructions, the PID is specified by setting Sa = 0x1000. The register is accessible according to the memory management special registers parameter C_MMU_TLB_ACCESS.

Figure 13: ZPR

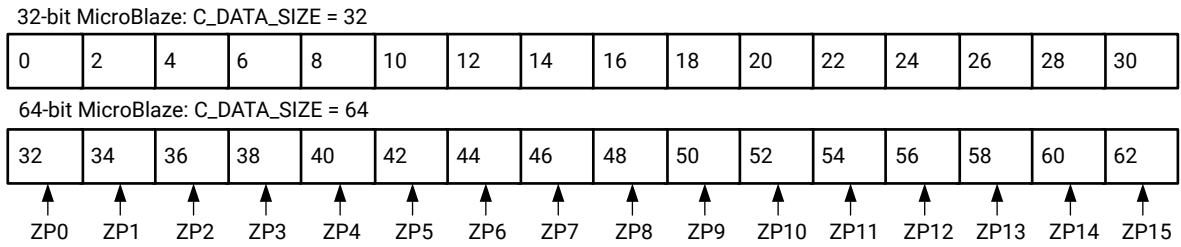

X19750-111517

Table 20: Zone Protection Register (ZPR)

Bits ¹	Name	Description	Reset Value
0:1	ZP0	Zone Protect <i>User mode (MSR[UM] = 1):</i> 00 = Override V in TLB entry. No access to the page is allowed. 01 = No override. Use V, WR and EX from TLB entry. 10 = No override. Use V, WR and EX from TLB entry. 11 = Override WR and EX in TLB entry. Access the page as writable and executable. <i>Privileged mode (MSR[UM] = 0):</i> 00 = No override. Use V, WR and EX from TLB entry. 01 = No override. Use V, WR and EX from TLB entry. 10 = Override WR and EX in TLB entry. Access the page as writable and executable. 11 = Override WR and EX in TLB entry. Access the page as writable and executable. Read/Write	0x0
2:3	ZP1		
...	...		
30:31	ZP15		
32:33	ZP0		
34:35	ZP1		
...	...		
62:63	ZP15		

Notes:

1. Bit numbers depend on if 64-bit MicroBlaze (C_DATA_SIZE = 64) is enabled or not.

Translation Look-Aside Buffer Low Register

The Translation Look-Aside Buffer Low (TLBLO) Register is used to access MMU Unified Translation Look-Aside Buffer (UTLB) entries. It is controlled by the C_USE_MMU configuration option on MicroBlaze. The register is only implemented if C_USE_MMU is greater than 1 (User Mode), and C_AREA_OPTIMIZED is set to 0 (Performance) or 2 (Frequency). When accessed with the MFS and MTS instructions, the TLBLO is specified by setting Sa = 0x1003.

When reading or writing TLBLO, the UTLB entry indexed by the TLBX register is accessed. The register is readable according to the memory management special registers parameter C_MMU_TLB_ACCESS.

When the MMU Physical Address Extension (PAE) is enabled (parameters `C_DATA_SIZE = 32`, `C_USE_MMU = 3` and `C_ADDR_SIZE > 32`), the 32 least significant bits of TLBLO are accessed with the MFS and MTS instructions, and the most significant bits with the MFSE and MTSE instruction. When writing the register with PAE enabled, the most significant bits must be written first.

With 64-bit MicroBlaze (parameter `C_DATA_SIZE = 64`) the entire register can be read with the MFS instruction.

The UTLB is reset on bit stream download (reset value is 0x00000000 for all TLBLO entries).

Note: The UTLB is *not* reset by the external reset inputs: `Reset` and `Debug_Rst`. This means that the entire UTLB must be initialized after reset, to avoid any stale data.

The following figure illustrates the TLBLO register and the following table provides bit descriptions and reset values. When PAE is enabled the RPN field of the register is extended according to the `C_ADDR_SIZE` parameter up to 54 bits to be able to hold up to a 64-bit physical address.

Figure 14: TLBLO

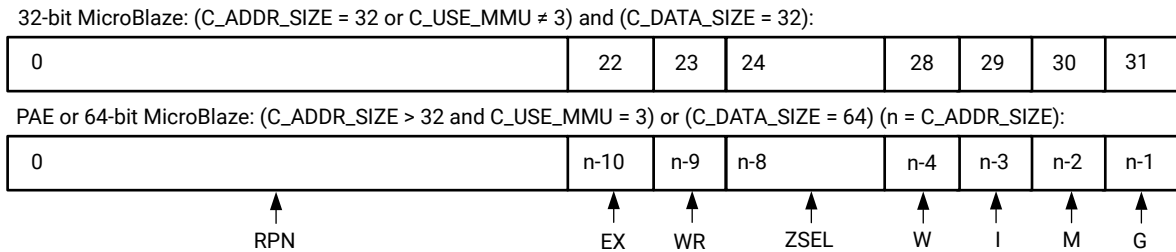

X19751-111517

Table 21: Translation Look-Aside Buffer Low Register (TLBLO)

Bits ¹	Name	Description	Reset Value
0:21 0:n-11	RPN	Real Page Number or Physical Page Number When a TLB hit occurs, this field is read from the TLB entry and is used to form the physical address. Depending on the value of the SIZE field, some of the RPN bits are not used in the physical address. Software must clear unused bits in this field to zero. Only defined when <code>C_USE_MMU=3</code> (Virtual). Read/Write	0x000000
22 n-10	EX	Executable When bit is set to 1, the page contains executable code, and instructions can be fetched from the page. When bit is cleared to 0, instructions cannot be fetched from the page. Attempts to fetch instructions from a page with a clear EX bit cause an instruction-storage exception. Read/Write	0

Table 21: Translation Look-Aside Buffer Low Register (TLBLO) (cont'd)

Bits ¹	Name	Description	Reset Value
23 n-9	WR	Writable When bit is set to 1, the page is writable and store instructions can be used to store data at addresses within the page. When bit is cleared to 0, the page is read-only (not writable). Attempts to store data into a page with a clear WR bit cause a data storage exception. Read/Write	0
24:27 n-8:n-5	ZSEL	Zone Select This field selects one of 16 zone fields (Z0-Z15) from the zone-protection register (ZPR). For example, if ZSEL 0x5, zone field Z5 is selected. The selected ZPR field is used to modify the access protection specified by the TLB entry EX and WR fields. It is also used to prevent access to a page by overriding the TLB V (valid) field. Read/Write	0x0
28 n-4	W	Write Through When the parameter C_DCACHE_USE_WRITEBACK is set to 1, this bit controls caching policy. A write-through policy is selected when set to 1, and a write-back policy is selected otherwise. This bit is fixed to 1, and write-through is always used, when C_DCACHE_USE_WRITEBACK is cleared to 0. Read/Write	0/1
29 n-3	I	Inhibit Caching When bit is set to 1, accesses to the page are not cached (caching is inhibited). When cleared to 0, accesses to the page are cacheable. Read/Write	0
30 n-2	M	Memory Coherent This bit is fixed to 0, because memory coherence is not implemented on MicroBlaze. Read Only	0
31 n-1	G	Guarded When bit is set to 1, speculative page accesses are not allowed (memory is guarded). When cleared to 0, speculative page accesses are allowed. The G attribute can be used to protect memory-mapped I/O devices from inappropriate instruction accesses. Read/Write	0

Notes:

1. The bit index n = C_ADDR_SIZE applies when PAE or 64-bit MicroBlaze is enabled.

Translation Look-Aside Buffer High Register

The Translation Look-Aside Buffer High (TLBHI) Register is used to access MMU Unified Translation Look-Aside Buffer (UTLB) entries. It is controlled by the C_USE_MMU configuration option on MicroBlaze. The register is only implemented if C_USE_MMU is greater than 1 (User Mode), and C_AREA_OPTIMIZED is set to 0 (Performance) or 2 (Frequency). When accessed with the MFS and MTS instructions, the TLBHI is specified by setting Sa = 0x1004. When reading or writing TLBHI, the UTLB entry indexed by the TLBX register is accessed.

The register is readable according to the memory management special registers parameter C_MMU_TLB_ACCESS.

PID is also used when accessing a TLB entry:

- When writing TLBHI the value of PID is stored in the TID field of the TLB entry.
- When reading TLBHI and MSR[UM] is not set, the value in the TID field is stored in PID.

The UTLB is reset on bit stream download (reset value is 0x00000000 for all TLBHI entries).

When 64-bit MicroBlaze is enabled (C_DATA_SIZE = 64), TLBHI has up to 64 bits, according to the C_ADDR_SIZE parameter, otherwise it has 32 bits.

Note: The UTLB is not reset by the external reset inputs: Reset and Debug_Rst.

The following figure illustrates the TLBHI register and the following table provides bit descriptions and reset values.

Figure 15: TLBHI

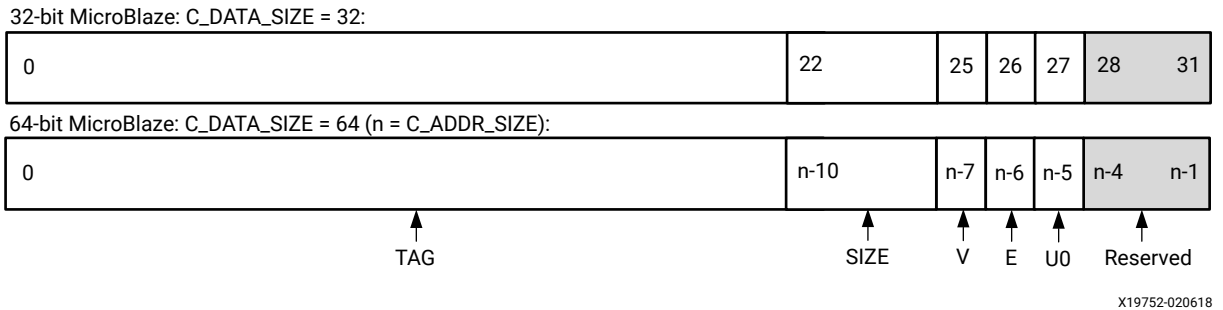

Table 22: Translation Look-Aside Buffer High Register (TLBHI)

Bits ¹	Name	Description	Reset Value
0:21 0:n-11	TAG	TLB-entry tag Is compared with the page number portion of the virtual memory address under the control of the SIZE field. Read/Write	0x0

Table 22: Translation Look-Aside Buffer High Register (TLBHI) (cont'd)

Bits ¹	Name	Description	Reset Value
22:24 n-10:n-8	SIZE	Size Specifies the page size. The SIZE field controls the bit range used in comparing the TAG field with the page number portion of the virtual memory address. The page sizes defined by this field are listed in Table 39: Page-Translation Bit Ranges by Page Size . Read/Write	000
25 n-7	V	Valid When this bit is set to 1, the TLB entry is valid and contains a page-translation entry. When cleared to 0, the TLB entry is invalid. Read/Write	0
26 n-6	E	Endian When this bit is set to 1, the page is accessed as a big endian page. When cleared to 0, the page is accessed as a little endian page. The E bit only affects data read or data write accesses. Instruction accesses are not affected. The E bit is only implemented when the parameter C_USE_REORDER_INSTR is set to 1, otherwise it is fixed to 0. Read/Write	0
27 n-5	U0	User Defined This bit is fixed to 0, because there are no user defined storage attributes on MicroBlaze. Read Only	0
28:31 n-4:n-1	Reserved		

Notes:

- The bit index n = C_ADDR_SIZE applies when 64-bit MicroBlaze is enabled.

Translation Look-Aside Buffer Index Register

The Translation Look-Aside Buffer Index (TLBX) Register is used as an index to the Unified Translation Look-Aside Buffer (UTLB) when accessing the TLBLO and TLBHI registers. It is controlled by the C_USE_MMU configuration option on MicroBlaze. The register is only implemented if C_USE_MMU is greater than 1 (User Mode), and C_AREA_OPTIMIZED is set to 0 (Performance) or 2 (Frequency). When accessed with the MFS and MTS instructions, the TLBX is specified by setting Sa = 0x1002.

The following figure illustrates the TLBX register and the following table provides bit descriptions and reset values.

When 64-bit MicroBlaze is enabled ($C_DATA_SIZE = 64$), TLBSX has up to 64 bits, according to the C_ADDR_SIZE parameter, otherwise it has 32 bits.

Figure 17: TLBSX

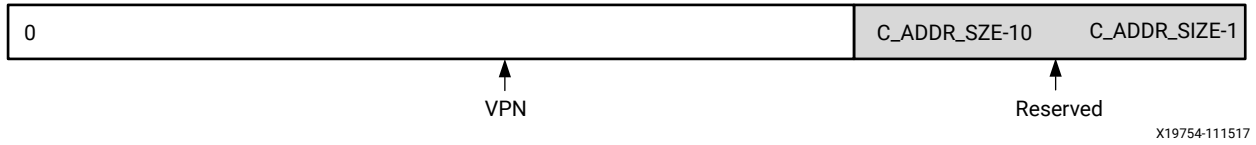

Table 24: Translation Look-Aside Buffer Index Search Register (TLBSX)

Bits ¹	Name	Description	Reset Value
0:21 0:n-9	VPN	Virtual Page Number This field represents the page number portion of the virtual memory address. It is compared with the page number portion of the virtual memory address under the control of the SIZE field, in each of the Translation Look-Aside Buffer entries that have the V bit set to 1. If the virtual page number is found, the TLBX register is written with the index of the TLB entry and the MISS bit in TLBX is cleared to 0. If the virtual page number is not found in any of the TLB entries, the MISS bit in the TLBX register is set to 1. Write Only	
22:31 n-10:n-1	Reserved		

Notes:

- The bit index $n = C_ADDR_SIZE$ applies when 64-bit MicroBlaze is enabled.

Processor Version Register

The Processor Version Register (PVR) is controlled by the C_PVR configuration option on MicroBlaze.

- When C_PVR is set to 0 (None) the processor does not implement any PVR and $MSR[PVR]=0$.
- When C_PVR is set to 1 (Basic), MicroBlaze implements only the first register: PVR0, and if set to 2 (Full), all 13 PVR registers (PVR0 to PVR12) are implemented.

When read with the MFS or MFSE instruction the PVR is specified by setting $Sa = 0x200x$, with x being the register number between $0x0$ and $0xB$.

With extended data addressing is enabled (parameter $C_DATA_SIZE = 32$ and $C_ADDR_SIZE > 32$), the 32 least significant bits of PVR8 and PVR9 are read with the MFS instruction, and the most significant bits with the MFSE instruction.

When physical address extension (PAE) is enabled (parameters $C_DATA_SIZE = 32$, $C_USE_MMU = 3$ and $C_ADDR_SIZE > 32$), the 32 least significant bits of PVR6 and PVR7 are read with the MFS instruction, and the most significant bits with the MFSE instruction.

With 64-bit MicroBlaze (parameter `C_DATA_SIZE = 64`) the entire contents of the PVR6 - PVR9 and PVR12 registers can be read with the MFS instruction.

Table 25: Processor Version Register 0 (PVR0) through Table 37: Processor Version Register 12 (PVR12) provide bit descriptions and values.

Table 25: Processor Version Register 0 (PVR0)

Bits ¹	Name	Description	Value
0, 32	CFG	PVR implementation: 0 = Basic, 1 = Full	Based on C_PVR
1, 33	BS	Use barrel shifter	C_USE_BARREL
2, 34	DIV	Use divider	C_USE_DIV
3, 35	MUL	Use hardware multiplier	C_USE_HW_MUL > 0 (None)
4, 36	FPU	Use FPU	C_USE_FPU > 0 (None)
5, 37	EXC	Use any type of exceptions	Based on C_*_EXCEPTION Also set if C_USE_MMU > 0 (None)
6, 38	ICU	Use instruction cache	C_USE_ICACHE
7, 39	DCU	Use data cache	C_USE_DCACHE
8, 40	MMU	Use MMU	C_USE_MMU > 0 (None)
9, 41	BTC	Use branch target cache	C_USE_BRANCH_TARGET_CACHE
10, 42	ENDI	Selected endianness: Always 1 = Little endian	C_ENDIANNES
11, 43	FT	Implement fault tolerant features	C_FAULT_TOLERANT
12, 44	SPROT	Use stack protection	C_USE_STACK_PROTECTION
13, 45	REORD	Implement reorder instructions	C_USE_REORDER_INSTR
14, 46	64BIT	64-bit MicroBlaze	C_DATA_SIZE = 64
15, 47	Reserved		0
16:23	MBV	MicroBlaze release version code	Release Specific
48:55		0x19 = v8.40.b 0x1B = v9.0 0x1D = v9.1 0x1F = v9.2 0x20 = v9.3	0x21 = v9.4 0x22 = v9.5 0x23 = v9.6 0x24 = v10.0 0x25 = v11.0
24:31 56:63	USR1	User configured value 1	C_PVR_USER1

Notes:

1. Bit numbers depend on if 64-bit MicroBlaze (`C_DATA_SIZE = 64`) is enabled or not.

Table 26: Processor Version Register 1 (PVR1)

Bits ¹	Name	Description	Value
0:31 32:63	USR2	User configured value 2	C_PVR_USER2

Notes:

1. Bit numbers depend on if 64-bit MicroBlaze (C_DATA_SIZE = 64) is enabled or not.

Table 27: Processor Version Register 2 (PVR2)

Bits ¹	Name	Description	Value
0, 32	DAXI	Data side AXI4 or ACE in use	C_D_AXI
1, 33	DLMB	Data side LMB in use	C_D_LMB
2, 34	IAXI	Instruction side AXI4 or ACE in use	C_I_AXI
3, 35	ILMB	Instruction side LMB in use	C_I_LMB
4, 36	IRQEDGE	Interrupt is edge triggered	C_INTERRUPT_IS_EDGE
5, 37	IRQPOS	Interrupt edge is positive	C_EDGE_IS_POSITIVE
6, 38	CEEXC	Generate bus exceptions for ECC correctable errors in LMB memory	C_ECC_USE_CE_EXCEPTION
7, 39	FREQ	Select implementation to optimize processor frequency	C_AREA_OPTIMIZED=2 (Frequency)
8, 40	Reserved		0
9, 41	Reserved		1
10, 42	ACE	Use ACE interconnect	C_INTERCONNECT = 3 (ACE)
11, 43	AXI4DP	Data Peripheral AXI interface uses AXI4 protocol, with support for exclusive access	C_M_AXI_DP_EXCLUSIVE_ACCESS
12, 44	FSL	Use extended AXI4-Stream instructions	C_USE_EXTENDED_FSL_INSTR
13, 45	FSLEXC	Generate exception for AXI4-Stream control bit mismatch	C_FSL_EXCEPTION
14, 46	MSR	Use msrset and msrlr instructions	C_USE_MSR_INSTR
15, 47	PCMP	Use pattern compare and CLZ instructions	C_USE_PCMP_INSTR
16, 48	AREA	Select implementation to optimize area with lower instruction throughput	C_AREA_OPTIMIZED = 1 (Area)
17, 49	BS	Use barrel shifter	C_USE_BARREL
18, 50	DIV	Use divider	C_USE_DIV
19, 51	MUL	Use hardware multiplier	C_USE_HW_MUL > 0 (None)
20, 52	FPU	Use FPU	C_USE_FPU > 0 (None)
21, 53	MUL64	Use 64-bit hardware multiplier	C_USE_HW_MUL = 2 (Mul64)
22, 54	FPU2	Use floating point conversion and square root instructions	C_USE_FPU = 2 (Extended)
23, 55	IMPEXC	Allow imprecise exceptions for ECC errors in LMB memory	C_IMPRECISE_EXCEPTIONS
24, 56	Reserved		0
25, 57	OP0EXC	Generate exception for 0x0 illegal opcode	C_OPCODE_0x0_ILLEGAL
26, 58	UNEXC	Generate exception for unaligned data access	C_UNALIGNED_EXCEPTIONS

Table 27: Processor Version Register 2 (PVR2) (cont'd)

Bits ¹	Name	Description	Value
27, 59	OPEXC	Generate exception for any illegal opcode	C_ILL_OPCODE_EXCEPTION
28, 60	AXIDEXC	Generate exception for M_AXI_D error	C_M_AXI_D_BUS_EXCEPTION
29, 61	AXIIEXC	Generate exception for M_AXI_I error	C_M_AXI_I_BUS_EXCEPTION
30, 62	DIVEXC	Generate exception for division by zero or division overflow	C_DIV_ZERO_EXCEPTION
31, 63	FPUExc	Generate exceptions from FPU	C_FPU_EXCEPTION

Notes:

1. Bit numbers depend on if 64-bit MicroBlaze (C_DATA_SIZE = 64) is enabled or not.

Table 28: Processor Version Register 3 (PVR3)

Bits ¹	Name	Description	Value
0, 32	DEBUG	Use debug logic	C_DEBUG_ENABLED > 0
1, 33	EXT_DEBUG	Use extended debug logic	C_DEBUG_ENABLED = 2 (Extended)
2, 34	Reserved		
3:6 35:38	PCBRK	Number of PC breakpoints	C_NUMBER_OF_PC_BRK
7:9 39:41	Reserved		
10:12 42:44	RDADDR	Number of read address breakpoints	C_NUMBER_OF_RD_ADDR_BRK
13:15 45:47	Reserved		
16:18 48:50	WRADDR	Number of write address breakpoints	C_NUMBER_OF_WR_ADDR_BRK
19, 51	Reserved		0
20:24 52:56	FSL	Number of AXI4-Stream links	C_FSL_LINKS
25:28 57:60	Reserved		
29:31 61:63	BTC_SIZE	Branch Target Cache size	C_BRANCH_TARGET_CACHE_SIZE

Notes:

1. Bit numbers depend on if 64-bit MicroBlaze (C_DATA_SIZE = 64) is enabled or not.

Table 29: Processor Version Register 4 (PVR4)

Bits ¹	Name	Description	Value
0, 32	ICU	Use instruction cache	C_USE_ICACHE
1:5 33:37	ICTS	Instruction cache tag size	C_ADDR_TAG_BITS

Table 29: Processor Version Register 4 (PVR4) (cont'd)

Bits ¹	Name	Description	Value
6, 38	Reserved		1
7, 39	ICW	Allow instruction cache write	C_ALLOW_ICACHE_WR
8:10 40:42	ICLL	The base two logarithm of the instruction cache line length	$\log_2(C_ICACHE_LINE_LEN)$
11:15 43:47	ICBS	The base two logarithm of the instruction cache byte size	$\log_2(C_CACHE_BYTE_SIZE)$
16, 48	IAU	The instruction cache is used for all memory accesses within the cacheable range	C_ICACHE_ALWAYS_USED
17:18 49:50	Reserved		0
19:21 51:53	ICV	Instruction cache victims	0-3: C_ICACHE_VICTIMS = 0,2,4,8
22:23 54:55	ICS	Instruction cache streams	C_ICACHE_STREAMS
24, 56	IFTL	Instruction cache tag uses distributed RAM	C_ICACHE_FORCE_TAG_LUTRAM
25, 57	ICDW	Instruction cache data width	C_ICACHE_DATA_WIDTH > 0
26:31 58:63	Reserved		0

Notes:

1. Bit numbers depend on if 64-bit MicroBlaze (C_DATA_SIZE = 64) is enabled or not.

Table 30: Processor Version Register 5 (PVR5)

Bits ¹	Name	Description	Value
0, 32	DCU	Use data cache	C_USE_DCACHE
1:5 33:37	DCTS	Data cache tag size	C_DCACHE_ADDR_TAG
6, 38	Reserved		1
7, 39	DCW	Allow data cache write	C_ALLOW_DCACHE_WR
8:10 40:42	DCLL	The base two logarithm of the data cache line length	$\log_2(C_DCACHE_LINE_LEN)$
11:15 43:47	DCBS	The base two logarithm of the data cache byte size	$\log_2(C_DCACHE_BYTE_SIZE)$
16, 48	DAU	The data cache is used for all memory accesses within the cacheable range	C_DCACHE_ALWAYS_USED
17, 49	DWB	Data cache policy is write-back	C_DCACHE_USE_WRITEBACK
18, 50	Reserved		0
19:21 51:53	DCV	Data cache victims	0-3: C_DCACHE_VICTIMS = 0,2,4,8
22:23 54:55	Reserved		0
24, 56	DFTL	Data cache tag uses distributed RAM	C_DCACHE_FORCE_TAG_LUTRAM

Table 30: Processor Version Register 5 (PVR5) (cont'd)

Bits ¹	Name	Description	Value
25, 57	DCDW	Data cache data width	C_DCACHE_DATA_WIDTH > 0
26, 58	AXI4DC	Data Cache AXI interface uses AXI4 protocol, with support for exclusive access	C_M_AXI_DC_EXCLUSIVE_ACCESS
27:31 59:63	Reserved		0

Notes:

1. Bit numbers depend on if 64-bit MicroBlaze (C_DATA_SIZE = 64) is enabled or not.

Table 31: Processor Version Register 6 (PVR6)

Bits	Name	Description	Value
0:C_ADDR_SIZE-1	ICBA	Instruction Cache Base Address	C_ICACHE_BASEADDR

Table 32: Processor Version Register 7 (PVR7)

Bits	Name	Description	Value
0:C_ADDR_SIZE-1	ICHA	Instruction Cache High Address	C_ICACHE_HIGHADDR

Table 33: Processor Version Register 8 (PVR8)

Bits	Name	Description	Value
0:C_ADDR_SIZE-1	DCBA	Data Cache Base Address	C_DCACHE_BASEADDR

Table 34: Processor Version Register 9 (PVR9)

Bits	Name	Description	Value
0:C_ADDR_SIZE-1	DCHA	Data Cache High Address	C_DCACHE_HIGHADDR

Table 35: Processor Version Register 10 (PVR10)

Bits ¹	Name	Description	Value
0:7 32:39	ARCH	Target architecture: 0xF = AMD Virtex™ 7, Defense Grade AMD Virtex™ 7 Q 0x10 = AMD Kintex™ 7, Defense Grade Kintex 7 Q 0x11 = AMD Artix™ 7, Automotive Artix 7, Defense Grade Artix 7 Q 0x12 = AMD Zynq™ 7000, Automotive Zynq 7000, Defense Grade Zynq 7000 Q 0x13 = AMD UltraScale™ Virtex 0x14 = Kintex UltraScale 0x15 = AMD Zynq™ UltraScale+™ 0x16 = Virtex UltraScale+ 0x17 = Kintex UltraScale+ 0x18 = Spartan™ 7 0x19 = AMD Versal™ 0x20 = Artix UltraScale+ 0x21 = Spartan UltraScale+	Defined by parameter C_FAMILY

Notes:

1. Bit numbers depend on if 64-bit MicroBlaze (C_DATA_SIZE = 64) is enabled or not.

Table 36: Processor Version Register 11 (PVR11)

Bits ¹	Name	Description	Value
0:1 32:33	MMU	Use MMU: 0 = None 1 = User Mode 2 = Protection 3 = Virtual	C_USE_MMU
2:4 34:36	ITLB	Instruction Shadow TLB size	$\log_2(C_MMU_ITLB_SIZE)$
5:7 37:39	DTLB	Data Shadow TLB size	$\log_2(C_MMU_DTLB_SIZE)$
8:9 40:41	TLBACC	TLB register access: 0 = Minimal 1 = Read 2 = Write 3 = Full	C_MMU_TLB_ACCESS
10:14 42:46	ZONES	Number of memory protection zones	C_MMU_ZONES
15, 47	PRIVINS	Privileged instructions: 0 = Full Protection 1 = Allow Stream Instructions	C_MMU_PRIVILEGED_INSTR
16, 48	Reserved	Reserved for future use	0

Table 36: Processor Version Register 11 (PVR11) (cont'd)

Bits ¹	Name	Description	Value
17:31 49:63	RSTMSR	Reset value for MSR	C_RESET_MSR_IE << 2 C_RESET_MSR_BIP << 4 C_RESET_MSR_ICE << 6 C_RESET_MSR_DCE << 8 C_RESET_MSR_EE << 9 C_RESET_MSR_EIP << 10

Notes:

1. Bit numbers depend on if 64-bit MicroBlaze (C_DATA_SIZE = 64) is enabled or not.

Table 37: Processor Version Register 12 (PVR12)

Bits ¹	Name	Description	Value
0:31 0:C_ADDR_SIZE-1	VECTORS	Location of MicroBlaze vectors	C_BASE_VECTORS

Notes:

1. C_ADDR_SIZE bits with 64-bit MicroBlaze (C_DATA_SIZE = 64) and 32 bits otherwise.

Pipeline Architecture

MicroBlaze instruction execution is pipelined. For most instructions, each stage takes one clock cycle to complete. Consequently, the number of clock cycles necessary for a specific instruction to complete is equal to the number of pipeline stages, and one instruction is completed on every cycle in the absence of data, control, or structural hazards.

A data hazard occurs when the result of an instruction is needed by a subsequent instruction. This can result in stalling the pipeline, unless the result can be forwarded to the subsequent instruction. The MicroBlaze GNU Compiler attempts to avoid data hazards by reordering instructions during optimization.

A control hazard occurs when a branch is taken, and the next instruction is not immediately available. This results in stalling the pipeline. MicroBlaze provides delay slot branches and the optional branch target cache to reduce the number of stall cycles.

A structural hazard occurs for a few instructions that require multiple clock cycles in the execute stage or a later stage to complete. This is achieved by stalling the pipeline.

Load and store instructions accessing slower memory might take multiple cycles. The pipeline is stalled until the access completes. MicroBlaze provides the optional data cache to improve the average latency of slower memory.

When executing from slower memory, instruction fetches might take multiple cycles. This additional latency directly affects the efficiency of the pipeline. MicroBlaze implements an instruction prefetch buffer that reduces the impact of such multi-cycle instruction memory latency. While the pipeline is stalled for any other reason, the prefetch buffer continues to load sequential instructions speculatively. When the pipeline resumes execution, the fetch stage can load new instructions directly from the prefetch buffer instead of waiting for the instruction memory access to complete.

If instructions are modified during execution (for example with self-modifying code), the prefetch buffer should be emptied before executing the modified instructions, to ensure that it does not contain the old unmodified instructions.



RECOMMENDED: *The recommended way to do this is using an MBAR instruction, although it is also possible to use a synchronizing branch instruction, for example BRI 4.*

MicroBlaze also provides the optional instruction cache to improve the average instruction fetch latency of slower memory.

All hazards are independent, and can potentially occur simultaneously. In such cases, the number of cycles the pipeline is stalled is defined by the hazard with the longest stall duration.

Three Stage Pipeline

With `C_AREA_OPTIMIZED` set to 1 (Area), the pipeline is divided into three stages to minimize hardware cost: Fetch, Decode, and Execute.

Figure 18: Three Stage Pipeline

	cycle1	cycle2	cycle3	cycle4	cycle5	cycle6	cycle7
Instruction 1	Fetch	Decode	Execute				
Instruction 2		Fetch	Decode	Execute	Execute	Execute	
Instruction 3			Fetch	Decode	Stall	Stall	Execute

X28183-060923

The three stage pipeline does not have any data hazards. Pipeline stalls are caused by control hazards, structural hazards due to multi-cycle instructions, memory accesses using slower memory, instruction fetch from slower memory, or stream accesses.

The multi-cycle instruction categories are barrel shift, multiply, divide, and floating-point instructions.

Five Stage Pipeline

With `C_AREA_OPTIMIZED` set to 0 (Performance), the pipeline is divided into five stages to maximize performance: Fetch (IF), Decode (OF), Execute (EX), Access Memory (MEM), and Writeback (WB).

Figure 19: Five Stage Pipeline

	cycle1	cycle2	cycle3	cycle4	cycle5	cycle6	cycle7	cycle8	cycle9
Instruction 1	IF	OF	EX	MEM	WB				
Instruction 2		IF	OF	EX	MEM	MEM	MEM	WB	
Instruction 3			IF	OF	EX	Stall	Stall	MEM	WB

X28186-061223

The five stage pipeline has two types of data hazard:

- An instruction in OF needs the result from an instruction in EX as a source operand. In this case, the EX instruction categories are load, store, barrel shift, multiply, divide, and floating-point instructions. This results in a 1-2 cycle stall.
- An instruction in OF uses the result from an instruction in MEM as a source operand. In this case, the MEM instruction categories are load, multiply, and floating-point instructions. This results in a 1 cycle stall.

Pipeline stalls are caused by data hazards, control hazards, structural hazards due to multi-cycle instructions, memory accesses using slower memory, instruction fetch from slower memory, or stream accesses.

The multi-cycle instruction categories are divide and floating-point instructions.

Eight Stage Pipeline

With `C_AREA_OPTIMIZED` set to 2 (Frequency), the pipeline is divided into eight stages to maximize possible frequency: Fetch (IF), Decode (OF), Execute (EX), Access Memory 0 (M0), Access Memory 1 (M1), Access Memory 2 (M2), Access Memory 3 (M3) and Writeback (WB).

Figure 20: Eight Stage Pipeline

	cycle1	cycle2	cycle3	cycle4	cycle5	cycle6	cycle7	cycle8	cycle9	cycle10	cycle11
Instruction 1	IF	OF	EX	M0	M1	M2	M3	WB			
Instruction 2		IF	OF	EX	M0	M0	M1	M2	M3	WB	
Instruction 3			IF	OF	EX	Stall	M0	M1	M2	M3	WB

X28187-061223

The eight stage pipeline has four types of data hazard:

- An instruction in OF needs the result from an instruction in EX as a source operand. In this case, the EX instruction categories are load, store, barrel shift, multiply, divide, and floating-point instructions. This results in a 1-5 cycle stall.
- An instruction in OF uses the result from an instruction in M0 as a source operand. In this case, the M0 instruction categories are load, multiply, divide, and floating-point instructions. This results in a 1-4 cycle stall.
- An instruction in OF uses the result from an instruction in M1 or M2 as a source operand. In this case, the M1 or M2 instruction categories are load, divide, and floating-point instructions. This results in a 1-3 or 1-2 cycle stall respectively.
- An instruction in OF uses the result from an instruction in M3 as a source operand. In this case, M3 instruction categories are load and floating-point instructions. This results in a 1 cycle stall.

In addition to multi-cycle instructions, there are two other types of structural hazards:

- An instruction in OF is a stream instruction, and the instruction in EX, M0, M1, M2, or M3 is a load, store, divide, or floating-point instruction with corresponding exception implemented. This results in a 1-5 cycle stall.
- An instruction in M0 is a load or store instruction, and the instruction in M1, M2, or M3 is a load, store, divide, or floating-point instruction with corresponding exception implemented. This results in a 1-3 cycle stall.

Pipeline stalls are caused by data hazards, control hazards, structural hazards, memory accesses using slower memory, instruction fetch from slower memory, or stream accesses.

The multi-cycle instruction categories are divide instructions and floating-point instructions FDIV, FLT, FSQRT, DDIV, DBL, and DSQRT.

Branches

Normally the instructions in the fetch and decode stages (as well as prefetch buffer) are flushed when executing a taken branch. The fetch pipeline stage is then reloaded with a new instruction from the calculated branch address. A taken branch in MicroBlaze takes three clock cycles to execute, two of which are required for refilling the pipeline. To reduce this latency overhead, MicroBlaze supports branches with delay slots and the optional branch target cache.

Delay Slots

When executing a taken branch with delay slot, only the fetch pipeline stage in MicroBlaze is flushed. The instruction in the decode stage (branch delay slot) is allowed to complete. This technique effectively reduces the branch penalty from two clock cycles to one. Branch instructions with delay slots have a D appended to the instruction mnemonic. For example, the BNE instruction does not execute the subsequent instruction (does not have a delay slot), whereas BNED executes the next instruction before control is transferred to the branch location.

A delay slot must not contain the following instructions: IMM, IMML, branch, or break. Interrupts and external hardware breaks are deferred until after the delay slot branch has been completed. Instructions that could cause recoverable exceptions (for example unaligned word or halfword load and store) are allowed in the delay slot.

If an exception is caused in a delay slot the ESR[DS] bit is set, and the exception handler is responsible for returning the execution to the branch target (stored in the special purpose register BTR). If the ESR[DS] bit is set, register R17 is not valid (otherwise it contains the address following the instruction causing the exception).

Branch Target Cache

To improve branch performance, MicroBlaze provides a branch target cache (BTC) coupled with a branch prediction scheme. With the BTC enabled, a correctly predicted immediate branch or return instruction incurs no overhead.

The BTC operates by saving the target address of each immediate branch and return instruction the first time the instruction is encountered. The next time it is encountered, it is usually found in the Branch Target Cache, and the Instruction Fetch Program Counter is then simply changed to the saved target address, in case the branch should be taken. Unconditional branches and return instructions are always taken, whereas conditional branches use branch prediction, to avoid taking a branch that should not be taken and vice versa.

The BTC is cleared when a memory barrier (MBAR 0) or synchronizing branch (BRI 4) is executed. This also occurs when the memory barrier or synchronizing branch follows immediately after a branch instruction, even if that branch is taken. To avoid inadvertently clearing the BTC, the memory barrier or synchronizing branch should not be placed immediately after a branch instruction.

There are three cases where the branch prediction can cause a mispredict, namely:

- A conditional branch that should not be taken, is actually taken,
- A conditional branch that should actually be taken, is not taken,
- The target address of a return instruction is incorrect, which might occur when returning from a function called from different places in the code.

All of these cases are detected and corrected when the branch or return instruction reaches the execute stage, and the branch prediction bits or target address are updated in the BTC, to reflect the actual instruction behavior. This correction incurs a penalty of 2 clock cycles for the 5-stage pipeline and 7 clock cycles (with MMU disabled) or 9 clock cycles (with MMU enabled) for the 8-stage pipeline due to additional instruction fetch pipeline stages.

The size of the BTC can be selected with `C_BRANCH_TARGET_CACHE_SIZE`. The default recommended setting uses one block RAM with 32-bit address (`C_ADDR_SIZE = 32`) and provides 512 entries. When selecting 64 entries or below, distributed RAM is used to implement the BTC, otherwise block RAM is used.

When the BTC uses block RAM, and `C_FAULT_TOLERANT` is set to 1, block RAMs are protected by parity. In case of a parity error, the branch is not predicted. To avoid accumulating errors in this case, the BTC should be cleared periodically by a synchronizing branch.

The Branch Target Cache is available when `C_USE_BRANCH_TARGET_CACHE` is set to 1 and `C_AREA_OPTIMIZED` is set to 0 (Performance) or 2 (Frequency).

Pipeline Hazard Example

The effect of a data hazard is illustrated in the following table, using the five stage pipeline.

The example shows a data hazard for a multiplication instruction, where the subsequent add instruction needs the result in register r3 to proceed. This means that the add instruction is stalled in OF during cycle 3 and 4 until the multiplication is complete.

Table 38: Multiplication Data Hazard Example

Cycle	IF	OF	EX	MEM	WB
1	mul r3, r4, r5				
2	add r6, r3, r4	mul r3, r4, r5			
3		add r6, r3, r4	mul r3, r4, r5		
4		add r6, r3, r4	-	mul r3, r4, r5	
5		add r6, r3, r4	-	-	mul r3, r4, r5
6			add r6, r3, r4	-	-

Avoiding Data Hazards

In some cases, the MicroBlaze GNU Compiler is not able to optimize code to completely avoid data hazards. However, it is often possible to change the source code to achieve this, mainly by better utilization of the general purpose registers.

Two C code examples are shown here:

- Multiplication of a static array in memory.

```
static int a[4], b[4], c[4];
register int a0, a1, a2, a3, b0, b1, b2, b3, c0, c1, c2, c3;

a0 = a[0]; a1 = a[1]; a2 = a[2]; a3 = a[3];
b0 = b[0]; b1 = b[1]; b2 = b[2]; b3 = b[3];
c0 = a0 * b0; c1 = a1 * b1; c2 = a2 * b2; c3 = a3 * b3;
c[3] = c3; c2 = c[2]; c1 = c[1]; c0 = c[0];
```

This code ensures that load instructions are first executed to load operands into separate registers, which are then multiplied and finally stored. The code can be extended up to 8 multiplications without running out of general purpose registers.

- Fetching a data packet from an AXI4-Stream interface.

```
#include <mb_interface.h>

static int a[4];
register int a0, a1, a2, a3;

getfsl(a0, 0); getfsl(a1, 0); getfsl(a2, 0); getfsl(a3, 0);
a[3] = a3; a[1] = a1; a[2] = a2; a[0] = a0;
```

This code ensures that get instructions using different registers are first executed, and then data is stored. The code can be extended to up to 16 accesses without running out of general purpose registers.

Memory Architecture

MicroBlaze is implemented with a Harvard memory architecture; instruction and data accesses are done in separate address spaces.

The instruction address space has a 32-bit virtual address range with 32-bit MicroBlaze (that is, handles up to 4 GB of instructions), and can be extended up to a 64-bit physical address range when using the MMU in virtual mode. With 64-bit MicroBlaze, the instruction address space has a default 32-bit range, and can be extended up to a 64-bit range (that is, handles from 4 GB to 16 EB of instructions).

The data address space has a default 32-bit range, and can be extended up to a 64-bit range (that is, handles from 4 GB to 16 EB of data). The instruction and data memory ranges can be made to overlap by mapping them both to the same physical memory. The latter is necessary for software debugging.

Both instruction and data interfaces of MicroBlaze are default 32 bits wide and use big endian or little endian, bit-reversed format, depending on the selected endianness. MicroBlaze supports word, halfword, and byte accesses to data memory.

Big endian format is supported when using the MMU in virtual or protected mode (`C_USE_MMU > 1`) or when reorder instructions are enabled (`C_USE_REORDER_INSTR = 1`).

Data accesses must be aligned (word accesses must be on word boundaries, halfword on halfword boundaries), unless the processor is configured to support unaligned exceptions. All instruction accesses must be word aligned.

MicroBlaze prefetches instructions to improve performance, using the instruction prefetch buffer and (if enabled) instruction cache streams. To avoid attempts to prefetch instructions beyond the end of physical memory, which might cause an instruction bus error or a processor stall, instructions must not be located too close to the end of physical memory. The instruction prefetch buffer requires 16 bytes margin, and using instruction cache streams adds two additional cache lines (32, 64, or 128 bytes).

MicroBlaze does not separate data accesses to I/O and memory (it uses memory-mapped I/O). The processor has up to three interfaces for memory accesses:

- Local Memory Bus (LMB)
- Advanced eXtensible Interface (AXI4) for peripheral access
- Advanced eXtensible Interface (AXI4) or AXI Coherency Extension (ACE) for cache access

The LMB memory address range must not overlap with AXI4 ranges.

The `C_ENDIANNES` parameter is always set to little endian.

MicroBlaze has a single cycle latency for accesses to local memory (LMB) and for cache read hits, except with `C_AREA_OPTIMIZED` set to 1 (Area), when data side accesses and data cache read hits require two clock cycles, and with `C_FAULT_TOLERANT` set to 1, when byte writes and halfword writes to LMB normally require two clock cycles.

The data cache write latency depends on `C_DCACHE_USE_WRITEBACK`. When `C_DCACHE_USE_WRITEBACK` is set to 1, the write latency normally is one cycle (more if the cache needs to do memory accesses). When `C_DCACHE_USE_WRITEBACK` is cleared to 0, the write latency normally is two cycles (more if the posted-write buffer in the memory controller is full).

The MicroBlaze instruction and data caches can be configured to use 4, 8, or 16 word cache lines. When using a longer cache line, more bytes are prefetched, which generally improves performance for software with sequential access patterns. However, for software with a more random access pattern the performance can instead decrease for a given cache size. This is caused by a reduced cache hit rate due to fewer available cache lines.

For details on the different memory interfaces, see [Chapter 3: MicroBlaze Signal Interface Description](#).

Privileged Instructions

The following MicroBlaze instructions are privileged:

- GET, GETD, PUT, PUTD (except when explicitly allowed)
- WIC, WDC
- MTS, MTSE
- MSRCLR, MSRSET (except when only the C bit is affected)
- BRK
- RTID, RTBD, RTED
- BRKI (except when jumping to physical address `C_BASE_VECTORS + 0x8` or `C_BASE_VECTORS + 0x18`)
- SLEEP, HIBERNATE, SUSPEND
- LBUEA, LHUEA, LWEA, SBEA, SHEA, SWEA (except when explicitly allowed)

Attempted use of these instructions when running in user mode causes a privileged instruction exception. When setting the parameter `C_MMU_PRIVILEGED_INSTR` to 1 or 3, the instructions GET, GETD, PUT, and PUTD are not considered privileged, and can be executed when running in user mode.



CAUTION! *It is strongly discouraged to do this, unless absolutely necessary for performance reasons, because it allows application processes to interfere with each other.*

When setting the parameter `C_MMU_PRIVILEGED_INSTR` to 2 or 3, the extended address instructions LBUEA, LHUEA, LWEA, SBEA, SHEA, and SWEA are not considered privileged, and will bypass the MMU translation, treating the extended address as a physical address. This is useful to run software in virtual mode while still having direct access to the full physical address space, but is discouraged in all cases where protection between application processes is necessary.

There are six ways to leave user mode and virtual mode:

1. Hardware generated reset (including debug reset)

2. Hardware exception
3. Non-maskable break or hardware break
4. Interrupt
5. Executing "`BRALID Re, C_BASE_VECTORS + 0x8`" to perform a user vector exception
6. Executing the software break instructions "`BRKI`" jumping to physical address `C_BASE_VECTORS + 0x8` or `C_BASE_VECTORS + 0x18`

In all of these cases, except hardware generated reset, the user mode and virtual mode status is saved in the MSR UMS and VMS bits.

Application (user-mode) programs transfer control to system-service routines (privileged mode programs) using the `BRALID` or `BRKI` instruction, jumping to physical address `C_BASE_VECTORS + 0x8`. Executing this instruction causes a system-call exception to occur. The exception handler determines which system-service routine to call and whether the calling application has permission to call that service. If permission is granted, the exception handler performs the actual procedure call to the system-service routine on behalf of the application program.

The execution environment expected by the system-service routine requires the execution of prologue instructions to set up that environment. Those instructions usually create the block of storage that holds procedural information (the activation record), update and initialize pointers, and save volatile registers (the registers that the system-service routine uses). Prologue code can be inserted by the linker when creating an executable module, or it can be included as stub code in either the system-call interrupt handler or the system-library routines.

Returns from the system-service routine reverse the process described above. Epilogue code is executed to unwind and deallocate the activation record, restore pointers, and restore volatile registers. The interrupt handler executes a return from exception instruction (`RTED`) to return to the application.

Virtual-Memory Management

Programs running on MicroBlaze use effective addresses to access a flat 4 GB address space with 32-bit MicroBlaze, and up to a 16 EB address space with 64-bit MicroBlaze depending on parameter `C_ADDR_SIZE`.

The processor can interpret this address space in one of two ways, depending on the translation mode:

- In real mode, effective addresses are used to directly access physical memory.
- In virtual mode, effective addresses are translated into physical addresses by the virtual-memory management hardware in the processor.

Virtual mode provides system software with the ability to relocate programs and data anywhere in the physical address space. System software can move inactive programs and data out of physical memory when space is required by active programs and data.

Relocation can make it appear to a program that more memory exists than is actually implemented by the system. This frees the programmer from working within the limits imposed by the amount of physical memory present in a system. Programmers do not need to know which physical-memory addresses are assigned to other software processes and hardware devices. The addresses visible to programs are translated into the appropriate physical addresses by the processor.

Virtual mode provides greater control over memory protection. Blocks of memory as small as 1 KB can be individually protected from unauthorized access. Protection and relocation enable system software to support multitasking. This capability gives the appearance of simultaneous or near-simultaneous execution of multiple programs.

In MicroBlaze, virtual mode is implemented by the memory-management unit (MMU), available when `C_USE_MMU` is set to 3 (Virtual) and `C_AREA_OPTIMIZED` is set to 0 (Performance) or 2 (Frequency). The MMU controls effective-address to physical-address mapping and supports memory protection. Using these capabilities, system software can implement demand-paged virtual memory and other memory management schemes.

The MicroBlaze MMU implementation is based upon the PowerPC™ 405 processor.

The MMU features are summarized as follows:

- Translates effective addresses into physical addresses
- Controls page-level access during address translation
- Provides additional virtual-mode protection control through the use of zones
- Provides independent control over instruction-address and data-address translation and protection
- Supports eight page sizes: 1 kB, 4 kB, 16 kB, 64 kB, 256 kB, 1 MB, 4 MB, and 16 MB. Any combination of page sizes can be used by system software
- Software controls the page-replacement strategy

Real Mode

The processor references memory when it fetches an instruction and when it accesses data with a load or store instruction. Programs reference memory locations using a 32-bit effective address with 32-bit MicroBlaze, and up to a 64-bit effective address with 64-bit MicroBlaze, calculated by the processor.

When real mode is enabled, the physical address is identical to the effective address and the processor uses it to access physical memory. After a processor reset, the processor operates in real mode. Real mode can also be enabled by clearing the VM bit in the MSR.

Physical-memory data accesses (loads and stores) are performed in real mode using the effective address. Real mode does not provide system software with virtual address translation, but the full memory access-protection is available, implemented when `C_USE_MMU > 1` (User Mode) and `C_AREA_OPTIMIZED = 0` (Performance) or 2 (Frequency). Implementation of a real-mode memory manager is more straightforward than a virtual-mode memory manager.

Real mode is often an appropriate solution for memory management in simple embedded environments, when access-protection is necessary, but virtual address translation is not required. This can be achieved by configuring memory management to act as a Memory Protection Unit (MPU) by setting `C_USE_MMU` to 2 (Protection).

Virtual Mode

In virtual mode, the processor translates an effective address into a physical address using the process shown in the following figure. With 64-bit MicroBlaze and with the Physical Address Extension (PAE) the physical address can be extended up to 64 bits. Virtual mode can be enabled by setting the VM bit in the MSR.

Figure 21: Virtual-Mode Address Translation

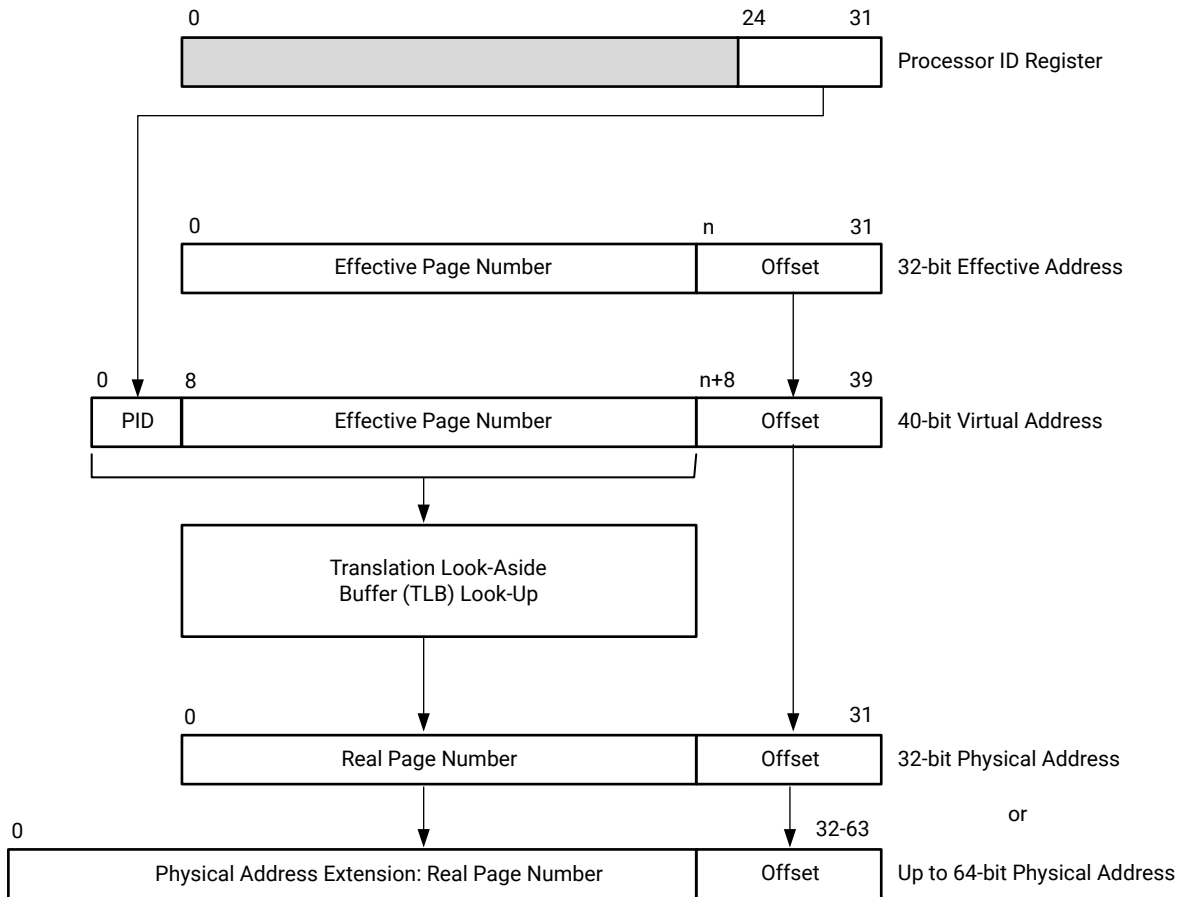

X19755-111617

Each address shown in the previous figure contains a page-number field and an offset field. The page number represents the portion of the address translated by the MMU. The offset represents the byte offset into a page and is not translated by the MMU. The virtual address consists of an additional field, called the process ID (PID), which is taken from the PID register (see [Process Identifier Register](#)). The combination of PID and effective page number (EPN) is referred to as the virtual page number (VPN). The value n is determined by the page size, as shown in ([Table 39: Page-Translation Bit Ranges by Page Size](#)).

System software maintains a page-translation table that contains entries used to translate each virtual page into a physical page. The page size defined by a page translation entry determines the size of the page number and offset fields. For example, with 32-bit MicroBlaze, when a 4 kB page size is used, the page-number field is 20 bits and the offset field is 12 bits. The VPN in this case is 28 bits.

Then the most frequently used page translations are stored in the translation look-aside buffer (TLB). When translating a virtual address, the MMU examines the page-translation entries for a matching VPN (PID and EPN). Rather than examining all entries in the table, only entries contained in the processor TLB are examined. When a page-translation entry is found with a matching VPN, the corresponding physical-page number is read from the entry and combined with the offset to form the physical address. This physical address is used by the processor to reference memory.

System software can use the PID to uniquely identify software processes (tasks, subroutines, threads) running on the processor. Independently compiled processes can operate in effective-address regions that overlap each other. This overlap must be resolved by system software if multitasking is supported. Assigning a PID to each process enables system software to resolve the overlap by relocating each process into a unique region of virtual-address space. The virtual-address space mappings enable independent translation of each process into the physical-address space.

Page-Translation Table

The page-translation table is a software-defined and software-managed data structure containing page translations. The requirement for software-managed page translation represents an architectural trade-off targeted at embedded-system applications. Embedded systems tend to have a tightly controlled operating environment and a well-defined set of application software. That environment enables virtual-memory management to be optimized for each embedded system in the following ways:

- The page-translation table can be organized to maximize page-table search performance (also called table walking) so that a given page-translation entry is located quickly. Most general-purpose processors implement either an indexed page table (simple search method, large page-table size) or a hashed page table (complex search method, small page-table size). With software table walking, any hybrid organization can be employed that suits the particular embedded system. Both the page-table size and access time can be optimized.
- Independent page sizes can be used for application modules, device drivers, system service routines, and data. Independent page-size selection enables system software to more efficiently use memory by reducing fragmentation (unused memory). For example, a large data structure can be allocated to a 16 MB page and a small I/O device-driver can be allocated to a 1 KB page.
- Page replacement can be tuned to minimize the occurrence of missing page translations. As described in the following section, the most-frequently used page translations are stored in the translation look-aside buffer (TLB).

Software is responsible for deciding which translations are stored in the TLB and which translations are replaced when a new translation is required. The replacement strategy can be tuned to avoid thrashing, whereby page-translation entries are constantly being moved in and out of the TLB. The replacement strategy can also be tuned to prevent replacement of critical-page translations, a process sometimes referred to as page locking.

The unified 64-entry TLB, managed by software, caches a subset of instruction and data page-translation entries accessible by the MMU. Software is responsible for reading entries from the page-translation table in system memory and storing them in the TLB. The following section describes the unified TLB in more detail. Internally, the MMU also contains shadow TLBs for instructions and data, with sizes configurable by `C_MMU_ITLB_SIZE` and `C_MMU_DTLB_SIZE` respectively.

These shadow TLBs are managed entirely by the processor (transparent to software) and are used to minimize access conflicts with the unified TLB.

Translation Look-Aside Buffer

The translation look-aside buffer (TLB) is used by the MicroBlaze MMU for address translation when the processor is running in virtual mode, memory protection, and storage control. Each entry within the TLB contains the information necessary to identify a virtual page (PID and effective page number), specify its translation into a physical page, determine the protection characteristics of the page, and specify the storage attributes associated with the page.

The MicroBlaze TLB is physically implemented as three separate TLBs:

- **Unified TLB:** The UTLB contains 64 entries and is pseudo-associative. Instruction-page and data-page translation can be stored in any UTLB entry. The initialization and management of the UTLB is controlled completely by software.
- **Instruction Shadow TLB:** The ITLB contains instruction page-translation entries and is fully associative. The page-translation entries stored in the ITLB represent the most-recently accessed instruction-page translations from the UTLB. The ITLB is used to minimize contention between instruction translation and UTLB-update operations. The initialization and management of the ITLB is controlled completely by hardware and is transparent to software.
- **Data Shadow TLB:** The DTLB contains data page-translation entries and is fully associative. The page-translation entries stored in the DTLB represent the most-recently accessed data-page translations from the UTLB. The DTLB is used to minimize contention between data translation and UTLB-update operations. The initialization and management of the DTLB is controlled completely by hardware and is transparent to software.

The following figure provides the translation flow for TLB.

Figure 22: TLB Address Translation Flow

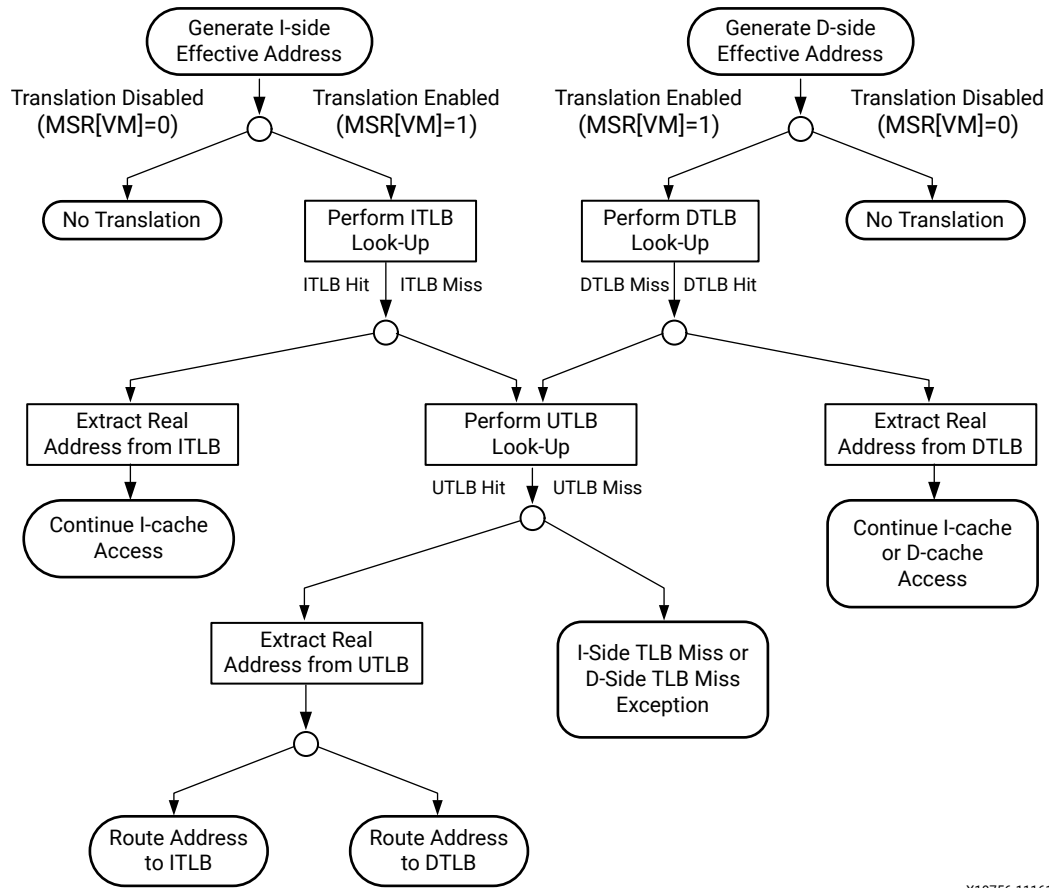

X19756-111617

TLB Entry Format

The following figure shows the format of a TLB entry. Each TLB entry ranges from 68 bits up to 100 bits and is composed of two portions: TLBLO (also referred to as the data entry), and TLBHI (also referred to as the tag entry).

Figure 23: TLB Entry Format (PAE Disabled)

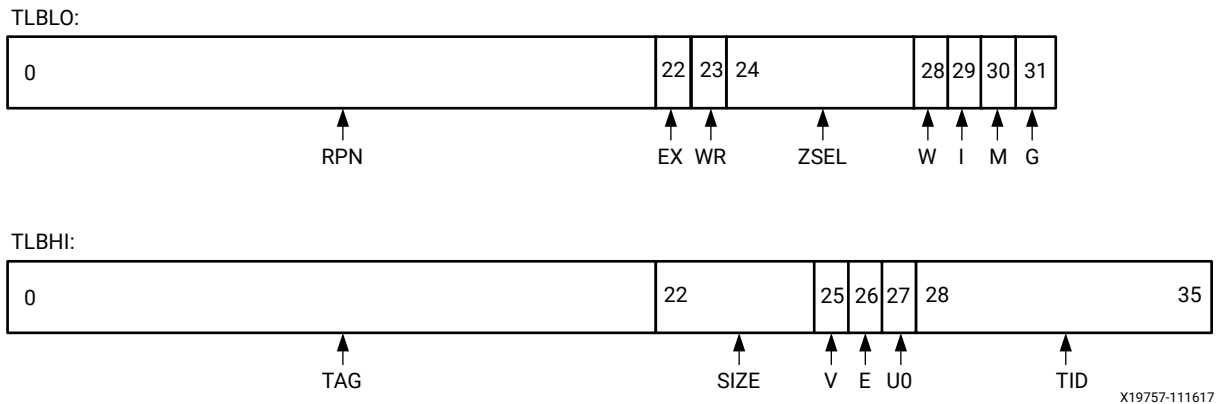

When 64-bit MicroBlaze or the Physical Address Extension (PAE) is enabled, the TLB entry is extended with up to 32 additional bits in the TLBLO RPN field to support up to a 64 bit physical address.

The TLB entry contents are described in more detail in [Translation Look-Aside Buffer Low Register](#) and [Translation Look-Aside Buffer High Register](#), including the TLBLO format with PAE or 64-bit MicroBlaze enabled.

The fields within a TLB entry are categorized as follows:

- Virtual-page identification (TAG, SIZE, V, TID): These fields identify the page-translation entry. They are compared with the virtual-page number during the translation process.
- Physical-page identification (RPN, SIZE): These fields identify the translated page in physical memory.
- Access control (EX, WR, ZSEL): These fields specify the type of access allowed in the page and are used to protect pages from improper accesses.
- Storage attributes (W, I, M, G, E, UO): These fields specify the storage-control attributes, such as caching policy for the data cache (write-back or write-through), whether a page is cacheable, and how bytes are ordered (endianness).

The following table shows the relationship between the TLB-entry SIZE field and the translated page size. This table also shows how the page size determines which address bits are involved in a tag comparison, which address bits are used as a page offset, and which bits in the physical page number are used in the physical address. With 64-bit MicroBlaze or PAE enabled, the most significant bits of the physical address are directly taken from the extended RPN field.

Table 39: Page-Translation Bit Ranges by Page Size

Page Size	SIZE TLBHI Field	Tag Comparison Bit Range ¹	Page Offset	PAE Disabled		PAE or 64-bit Enabled ²	
				Physical Page Number	RPN Bits Clear to 0	Physical Page Number	RPN Bits Clear to 0
1 KB	000	TAG and Address[0:n-11]	Address[22:31]	RPN[0:21]	-	RPN[0:n-11]	-
4 KB	001	TAG and Address[0:n-13]	Address[20:31]	RPN[0:19]	20:21	RPN[0:n-13]	n-12:n-11
16 KB	010	TAG and Address[0:n-15]	Address[18:31]	RPN[0:17]	18:21	RPN[0:n-15]	n-14:n-11
64 KB	011	TAG and Address[0:n-17]	Address[16:31]	RPN[0:15]	16:21	RPN[0:n-17]	n-16:n-11
256 KB	100	TAG and Address[0:n-19]	Address[14:31]	RPN[0:13]	14:21	RPN[0:n-19]	n-18:n-11
1 MB	101	TAG and Address[0:n-21]	Address[12:31]	RPN[0:11]	12:21	RPN[0:n-21]	n-20:n-11
4 MB	110	TAG and Address[0:n-23]	Address[10:31]	RPN[0:9]	10:21	RPN[0:n-23]	n-22:n-11
16 MB	111	TAG and Address[0:n-25]	Address[8:31]	RPN[0:7]	8:21	RPN[0:n-25]	n-24:n-11

Notes:

1. The bit index $n = C_ADDR_SIZE$ with 64-bit MicroBlaze, and 32 otherwise.
2. The bit index $n = C_ADDR_SIZE$.

TLB Access

When the MMU translates a virtual address (the combination of PID and effective address) into a physical address, it first examines the appropriate shadow TLB for the page translation entry. If an entry is found, it is used to access physical memory. If an entry is not found, the MMU examines the UTLB for the entry. A delay occurs each time the UTLB must be accessed due to a shadow TLB miss. The miss latency ranges from 2-32 cycles. The DTLB has priority over the ITLB if both simultaneously access the UTLB.

[Figure 24: General Process for Examining a TLB Entry](#) shows the logical process the MMU follows when examining a page-translation entry in one of the shadow TLBs or the UTLB. All valid entries in the TLB are checked.

A TLB hit occurs when all of the following conditions are met by a TLB entry:

- The entry is valid
- The TAG field in the entry matches the effective address EPN under the control of the SIZE field in the entry
- The TID field in the entry matches the PID

If any of the above conditions are not met, a TLB miss occurs. A TLB miss causes an exception, described as follows:

A TID value of 0x00 causes the MMU to ignore the comparison between the TID and PID. Only the TAG and EA[EPN] are compared. A TLB entry with TID=0x00 represents a process-independent translation. Pages that are accessed globally by all processes should be assigned a TID value of 0x00. A PID value of 0x00 does not identify a process that can access any page. When PID=0x00, a page-translation hit only occurs when TID=0x00. It is possible for software to load the TLB with multiple entries that match an EA[EPN] and PID combination. However, this is considered a programming error and results in undefined behavior.

When a hit occurs, the MMU reads the RPN field from the corresponding TLB entry. Some or all of the bits in this field are used, depending on the value of the SIZE field (see the previous table).

For example, with PAE disabled and 32-bit MicroBlaze, if the SIZE field specifies a 256 kB page size, RPN[0:13] represents the physical page number and is used to form the physical address. RPN[14:21] is not used, and software must clear those bits to 0 when initializing the TLB entry. The remainder of the physical address is taken from the page-offset portion of the EA. If the page size is 256 kB, the 32-bit physical address is formed by concatenating RPN[0:13] with bits 14:31 of the effective address.

Instead, with PAE enabled and assuming a physical address size of 40 bits (C_ADDR_SIZE set to 40), RPN[0:21] represents the physical page number and RPN[22:29] is not used. The 40-bit physical address is formed by concatenating RPN[0:21] with bits 14:31 of the effective address.

Prior to accessing physical memory, the MMU examines the TLB-entry access-control fields. These fields indicate whether the currently executing program is allowed to perform the requested memory access.

If access is allowed, the MMU checks the storage-attribute fields to determine how to access the page. The storage-attribute fields specify the caching policy for memory accesses.

TLB Access Failures

A TLB-access failure causes an exception to occur. This interrupts execution of the instruction that caused the failure and transfers control to an interrupt handler to resolve the failure. A TLB access can fail for two reasons:

- A matching TLB entry was not found, resulting in a TLB miss.
- A matching TLB entry was found, but access to the page was prevented by either the storage attributes or zone protection.

When an interrupt occurs, the processor enters real mode by clearing MSR[VM] to 0. In real mode, all address translation and memory-protection checks performed by the MMU are disabled. After system software initializes the UTLB with page-translation entries, management of the MicroBlaze UTLB is usually performed using interrupt handlers running in real mode.

The following figure diagrams the general process for examining a TLB entry.

Figure 24: General Process for Examining a TLB Entry

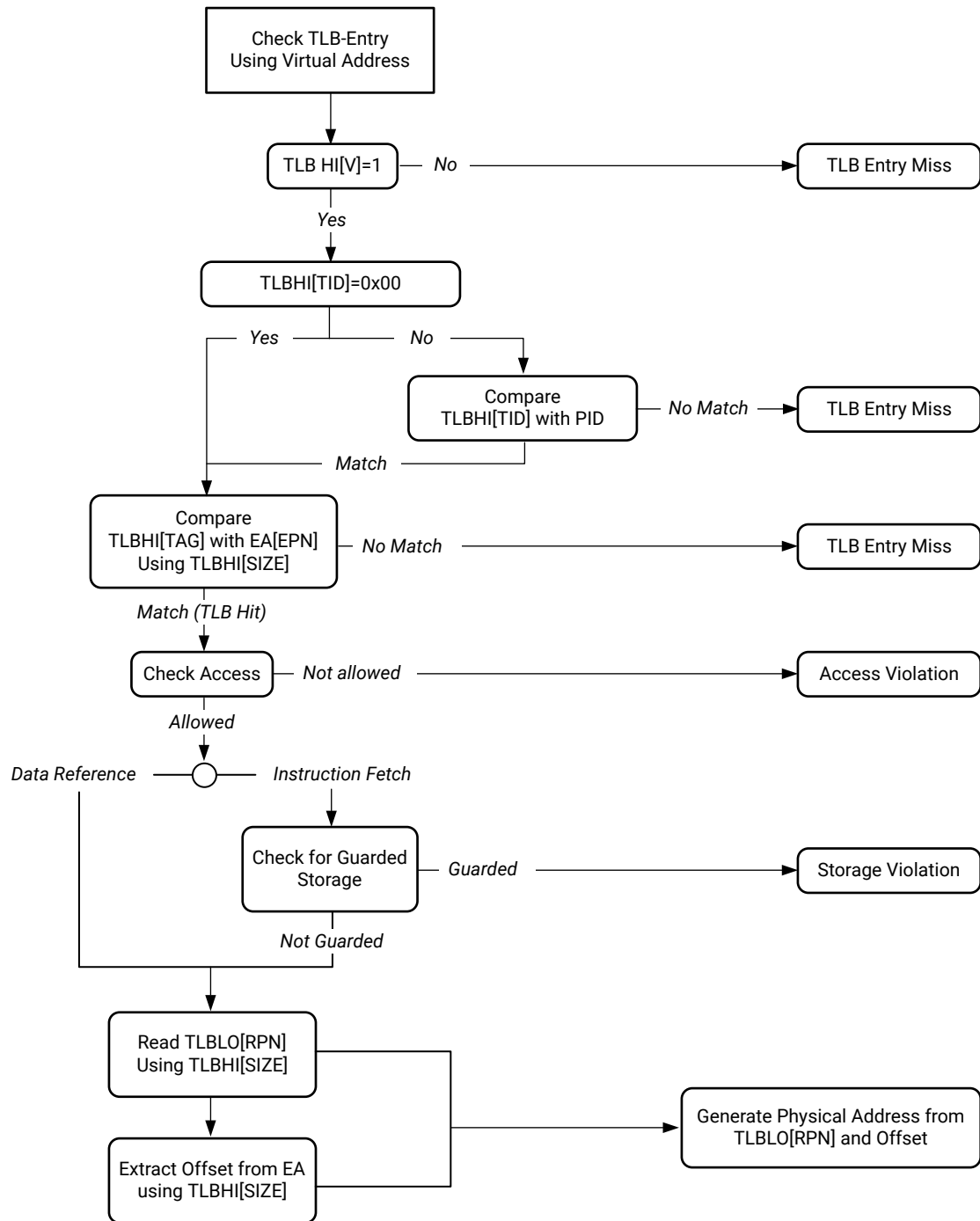

X19758-111617

The following sections describe the conditions under which exceptions occur due to TLB access failures.

Data-Storage Exception

When virtual mode is enabled, (MSR[VM]=1), a data-storage exception occurs when access to a page is not permitted for any of the following reasons:

- From user mode:
 - The TLB entry specifies a zone field that prevents access to the page (ZPR[Zn]=00). This applies to load and store instructions.
 - The TLB entry specifies a read-only page (TLBLO[WR]=0) that is not otherwise overridden by the zone field (ZPR[Zn], 11). This applies to store instructions.
- From privileged mode:
 - The TLB entry specifies a read-only page (TLBLO[WR]=0) that is not otherwise overridden by the zone field (ZPR[Zn], 10 and ZPR[Zn], 11). This applies to store instructions.

Instruction-Storage Exception

When virtual mode is enabled, (MSR[VM]=1), an instruction-storage exception occurs when access to a page is not permitted for any of the following reasons:

- From user mode:
 - The TLB entry specifies a zone field that prevents access to the page (ZPR[Zn]=00).
 - The TLB entry specifies a non-executable page (TLBLO[EX]=0) that is not otherwise overridden by the zone field (ZPR[Zn], 11).
 - The TLB entry specifies a guarded-storage page (TLBLO[G]=1).
- From privileged mode:
 - The TLB entry specifies a non-executable page (TLBLO[EX]=0) that is not otherwise overridden by the zone field (ZPR[Zn], 10 and ZPR[Zn], 11).
 - The TLB entry specifies a guarded-storage page (TLBLO[G]=1).

Data TLB-Miss Exception

When virtual mode is enabled (MSR[VM]=1) a data TLB-miss exception occurs if a valid, matching TLB entry was not found in the TLB (shadow and UTLB). Any load or store instruction can cause a data TLB-miss exception.

Instruction TLB-Miss Exception

When virtual mode is enabled (MSR[VM]=1) an instruction TLB-miss exception occurs if a valid, matching TLB entry was not found in the TLB (shadow and UTLB). Any instruction fetch can cause an instruction TLB-miss exception.

Access Protection

System software uses access protection to protect sensitive memory locations from improper access. System software can restrict memory accesses for both user-mode and privileged-mode software. Restrictions can be placed on reads, writes, and instruction fetches. Access protection is available when virtual protected mode is enabled.

Access control applies to instruction fetches, data loads, and data stores. The TLB entry for a virtual page specifies the type of access allowed to the page.

The TLB entry also specifies a zone-protection field in the zone-protection register that is used to override the access controls specified by the TLB entry.

TLB Access-Protection Controls

Each TLB entry controls three types of access:

- **Process:**

Processes are protected from unauthorized access by assigning a unique process ID (PID) to each process. When system software starts a user-mode application, it loads the PID for that application into the PID register. As the application executes, memory addresses are translated using only TLB entries with a TID field in Translation Look-Aside Buffer High (TLBHI) that matches the PID. This enables system software to restrict accesses for an application to a specific area in virtual memory.

A TLB entry with TID=0x00 represents a process-independent translation. Pages that are accessed globally by all processes should be assigned a TID value of 0x00.

- **Execution:** The processor executes instructions only if they are fetched from a virtual page marked as executable (TLBLO[EX]=1). Clearing TLBLO[EX] to 0 prevents execution of instructions fetched from a page, instead causing an instruction-storage interrupt (ISI) to occur. The ISI does not occur when the instruction is fetched, but instead occurs when the instruction is executed. This prevents speculatively fetched instructions that are later discarded (rather than executed) from causing an ISI.

The zone-protection register can override execution protection.

- **Read/Write:** Data is written only to virtual pages marked as writable (TLBLO[WR]=1). Clearing TLBLO[WR] to 0 marks a page as read-only. An attempt to write to a read-only page causes a data-storage interrupt (DSI) to occur.

The zone-protection register can override write protection.

TLB entries cannot be used to prevent programs from reading pages. In virtual mode, zone protection is used to read-protect pages. This is done by defining a no-access-allowed zone ($ZPR[Zn] = 00$) and using it to override the TLB-entry access protection. Only programs running in user mode can be prevented from reading a page. Privileged programs always have read access to a page.

Zone Protection

Zone protection is used to override the access protection specified in a TLB entry. Zones are an arbitrary grouping of virtual pages with common access protection. Zones can contain any number of pages specifying any combination of page sizes. There is no requirement for a zone to contain adjacent pages.

The zone-protection register (ZPR) is a 32-bit register used to specify the type of protection override applied to each of 16 possible zones. The protection override for a zone is encoded in the ZPR as a 2-bit field.

The 4-bit zone-select field in a TLB entry (TLBLO[ZSEL]) selects one of the 16 zone fields from the ZPR (Z0–Z15). For example, zone Z5 is selected when ZSEL = 0101.

Changing a zone field in the ZPR applies a protection override across all pages in that zone. Without the ZPR, protection changes require individual alterations to each page translation entry within the zone.

Unimplemented zones (when $C_MMU_ZONES < 16$) are treated as if they contained 11.

UTLB Management

The UTLB serves as the interface between the processor MMU and memory-management software. System software manages the UTLB to tell the MMU how to translate virtual addresses into physical addresses. When a problem occurs due to a missing translation or an access violation, the MMU communicates the problem to system software using the exception mechanism. System software is responsible for providing interrupt handlers to correct these problems so that the MMU can proceed with memory translation.

Software reads and writes UTLB entries using the MFS and MTS instructions, respectively. With PAE enabled, the MFSE and MTSE instructions are used to access the most significant part of the real page number. These instructions use the TLBX register index (numbered 0 to 63) corresponding to one of the 64 entries in the UTLB. The tag and data portions are read and written separately, so software must execute two MFS or MTS instructions, and also an additional MFSE or MTSE instruction when PAE is enabled, to completely access an entry.

With 64-bit MicroBlaze, the MFS and MTS instructions can access the entire contents of the UTLB entry directly.

The UTLB is searched for a specific translation using the TLBSX register. TLBSX locates a translation using an effective address and loads the corresponding UTLB index into the TLBX register.

Individual UTLB entries are invalidated using the MTS instruction to clear the valid bit in the tag portion of a TLB entry (TLBHI[V]).

When `C_FAULT_TOLERANT` is set to 1, the UTLB block RAM is protected by parity. In case of a parity error, a TLB miss exception occurs. To avoid accumulating errors in this case, each entry in the UTLB should be periodically invalidated.

Recording Page Access and Page Modification

Software management of virtual-memory poses several challenges:

- In a virtual-memory environment, software and data often consume more memory than is physically available. Some of the software and data pages must be stored outside physical memory, such as on a hard drive, when they are not used. Ideally, the most-frequently used pages stay in physical memory and infrequently used pages are stored elsewhere.
- When pages in physical-memory are replaced to make room for new pages, it is important to know whether the replaced (old) pages were modified.

If they were modified, they must be saved prior to loading the replacement (new) pages. If the old pages were not modified, the new pages can be loaded without saving the old pages.

- A limited number of page translations are kept in the UTLB. The remaining translations must be stored in the page-translation table. When a translation is not found in the UTLB (due to a miss), system software must decide which UTLB entry to discard so that the missing translation can be loaded. It is desirable for system software to replace infrequently used translations rather than frequently used translations.

Solving the above problems in an efficient manner requires keeping track of page accesses and page modifications. MicroBlaze does not track page access and page modification in hardware. Instead, system software can use the TLB-miss exceptions and the data-storage exception to collect this information. As the information is collected, it can be stored in a data structure associated with the page-translation table.

Page-access information is used to determine which pages should be kept in physical memory and which are replaced when physical-memory space is required. System software can use the valid bit in the TLB entry (TLBHI[V]) to monitor page accesses. This requires page translations be initialized as not valid (TLBHI[V]=0) to indicate they have not been accessed. The first attempt to access a page causes a TLB-miss exception, either because the UTLB entry is marked not valid or because the page translation is not present in the UTLB. The TLB-miss handler updates the UTLB with a valid translation (TLBHI[V]=1). The set valid bit serves as a record that the page and its translation have been accessed. The TLB-miss handler can also record the information in a separate data structure associated with the page-translation entry.

Page-modification information is used to indicate whether an old page can be overwritten with a new page or the old page must first be stored to a hard disk. System software can use the write-protection bit in the TLB entry (TLBLO[WR]) to monitor page modification. This requires page translations be initialized as read-only (TLBLO[WR]=0) to indicate they have not been modified. The first attempt to write data into a page causes a data-storage exception, assuming the page has already been accessed and marked valid as described above. If software has permission to write into the page, the data-storage handler marks the page as writable (TLBLO[WR]=1) and returns.

The set write-protection bit serves as a record that a page has been modified. The data-storage handler can also record this information in a separate data structure associated with the page-translation entry.

Tracking page modification is useful when virtual mode is first entered and when a new process is started.

Reset, Interrupts, Exceptions, and Break

MicroBlaze supports reset, interrupt, user exception, break, and hardware exceptions. The following section describes the execution flow associated with each of these events.

The relative priority starting with the highest is:

1. Reset
2. Hardware Exception
3. Non-maskable Break
4. Break
5. Interrupt
6. User Vector (Exception)

The following table defines the memory address locations of the associated vectors and the hardware enforced register file locations for return addresses. Each vector allocates two addresses to allow full address range branching (requires an IMM followed by a BRAI instruction). Normally the vectors start at address 0, but the parameter `C_BASE_VECTORS` can be used to locate them anywhere in memory.

The address range 0x28 to 0x4F is reserved for future software support. Allocating these addresses for user applications is likely to conflict with future releases of support software.

Table 40: Vectors and Return Address Register File Location

Event	Vector Address	Register File Return Address
Reset	C_BASE_VECTORS + 0x0 - C_BASE_VECTORS + 0x4	-
User Vector (Exception)	C_BASE_VECTORS + 0x8 - C_BASE_VECTORS + 0xC	RX
Interrupt ¹	C_BASE_VECTORS + 0x10 - C_BASE_VECTORS + 0x14	R14
Break: Non-maskable hardware	C_BASE_VECTORS + 0x18 -	R16
Break: Hardware	C_BASE_VECTORS + 0x1C	
Break: Software		
Hardware Exception	C_BASE_VECTORS + 0x20 - C_BASE_VECTORS + 0x24	R17 or BTR
Reserved for future use	C_BASE_VECTORS + 0x28 - C_BASE_VECTORS + 0x4F	-

Notes:

1. With low-latency interrupt mode, the vector address is supplied by the Interrupt Controller.

All of these events will clear the reservation bit, used together with the LWX and SWX instructions to implement mutual exclusion, such as semaphores and spinlocks.

Reset

When a Reset or `Debug_Rst`¹ occurs, MicroBlaze flushes the pipeline and immediately starts fetching instructions from the reset vector (address `C_BASE_VECTORS + 0x0`). Both external reset signals are active-High, and it is recommended to assert the signals for at least 16 cycles.

See [MicroBlaze Core Configurability](#) for more information on the MSR reset value parameters, which are used to define the initial value of the Machine Status Register.

Reset does not clear the general purpose registers (r1 - r31) or the instruction and data caches. To ensure that stale data is not used, software should not assume that the general purpose registers are zero, and the program should invalidate instruction and data caches before they are enabled. See [Reset Handling](#) for a C code example of cache invalidation.

MicroBlaze does not wait for outstanding AXI or LMB transactions to complete before it begins fetching instructions from the reset vector. When only resetting the processor, all external accesses must be completed before asserting Reset. This can be achieved with an MBAR instruction to enter sleep mode or the Pause signal. See [Sleep and Pause Functionality](#) for details.

Note:

1. Reset input controlled by the debugger using MDM.

Equivalent Pseudocode

```

PC ← C_BASE_VECTORS + 0x0
MSR ← C_RESET_MSR_IE << 2 | C_RESET_MSR_BIP << 4 | C_RESET_MSR_ICE << 6 |
      C_RESET_MSR_DCE << 8 | C_RESET_MSR_EE << 9 | C_RESET_MSR_EIP << 10
EAR ← 0; ESR ← 0; FSR ← 0
PID ← 0; ZPR ← 0; TLBX ← 0
Reservation ← 0

```

Hardware Exceptions

MicroBlaze can be configured to trap the following internal error conditions: illegal instruction, instruction and data bus error, and unaligned access. The divide exception can only be enabled if the processor is configured with a hardware divider (`C_USE_DIV=1`).

When configured with a hardware floating-point unit (`C_USE_FPU>0`), it can also trap the following floating-point specific exceptions: underflow, overflow, float division-by-zero, invalid operation, and denormalized operand error.

When configured with a hardware memory management unit (MMU), it can also trap the following memory management specific exceptions: Illegal Instruction Exception, Data Storage Exception, Instruction Storage Exception, Data TLB Miss Exception, and Instruction TLB Miss Exception.

A hardware exception causes MicroBlaze to flush the pipeline and branch to the hardware exception vector (address `C_BASE_VECTORS + 0x20`). The execution stage instruction in the exception cycle is not executed.

The exception also updates the general purpose register R17 in the following manner:

- For the MMU exceptions (Data Storage Exception, Instruction Storage Exception, Data TLB Miss Exception, Instruction TLB Miss Exception) the register R17 is loaded with the appropriate program counter value to re-execute the instruction causing the exception upon return. The value is adjusted to return to a preceding `IMM` instruction, if any. If the exception is caused by an instruction in a branch delay slot, the value is adjusted to return to the branch instruction, including adjustment for a preceding `IMM` instruction, if any.
- For all other exceptions the register R17 is loaded with the program counter value of the subsequent instruction, unless the exception is caused by an instruction in a branch delay slot. If the exception is caused by an instruction in a branch delay slot, the `ESR[DS]` bit is set. In this case the exception handler should resume execution from the branch target address stored in `BTR`.

The `EE` and `EIP` bits in `MSR` are automatically reverted when executing the `RTED` instruction.

The `VM` and `UM` bits in `MSR` are automatically reverted from `VMS` and `UMS` when executing the `RTED`, `RTBD`, and `RTID` instructions.

Exception Priority

When two or more exceptions occur simultaneously, they are handled in the following order, from the highest priority to the lowest:

- Instruction Bus Exception
- Instruction TLB Miss Exception
- Instruction Storage Exception
- Illegal Opcode Exception
- Privileged Instruction Exception or Stack Protection Violation Exception
- Data TLB Miss Exception
- Data Storage Exception
- Unaligned Exception
- Data Bus Exception
- Divide Exception
- FPU Exception
- Stream Exception

Exception Causes

- **Stream Exception:** The AXI4-Stream exception is caused by executing a get or getd instruction with the 'e' bit set to '1' when there is a control bit mismatch.
- **Instruction Bus Exception:** The instruction bus exception is caused by errors when reading data from memory.
 - The instruction peripheral AXI4 interface (`M_AXI_IP`) exception is caused by an error response on `M_AXI_IP_RRESP`.
 - The instruction cache AXI4 interface (`M_AXI_IC`) exception is caused by an error response on `M_AXI_IC_RRESP`. The exception can only occur when the parameter `C_ICACHE_ALWAYS_USED` is set to 1 and the cache is turned off, or if the MMU Inhibit Caching bit is set for the address. In all other cases the response is ignored.
 - The instructions side local memory (ILMB) can only cause instruction bus exception when either an uncorrectable error occurs in the LMB memory, as indicated by the `IUE` signal, or `C_ECC_USE_CE_EXCEPTION` is set to 1 and a correctable error occurs in the LMB memory, as indicated by the `ICE` signal.

- **Illegal Opcode Exception:** The illegal opcode exception is caused by an instruction with an invalid major opcode (bits 0 through 5 of instruction). Bits 6 through 31 of the instruction are not checked. Optional processor instructions are detected as illegal if not enabled. If the optional feature `C_OPCODE_0x0_ILLEGAL` is enabled, an illegal opcode exception is also caused if the instruction is equal to `0x00000000`.
- **Data Bus Exception:** The data bus exception is caused by errors when reading data from memory or writing data to memory.
 - The data peripheral AXI4 interface (`M_AXI_DP`) exception is caused by an error response on `M_AXI_DP_RRESP` or `M_AXI_DP_BRESP`.
 - The data cache AXI4 interface (`M_AXI_DC`) exception is caused by:
 - An error response on `M_AXI_DC_RRESP` or `M_AXI_DC_BRESP`,
 - OKAY response on `M_AXI_DC_RRESP` in case of an exclusive access using `LWX`.

The exception can only occur when `C_DCACHE_ALWAYS_USED` is set to 1 and the cache is turned off, when an exclusive access using `LWX` or `SWX` is performed, or if the MMU Inhibit Caching bit is set for the address. In all other cases the response is ignored.
 - The data side local memory (DLMB) can only cause instruction bus exception when either an uncorrectable error occurs in the LMB memory, as indicated by the `DUE` signal, or `C_ECC_USE_CE_EXCEPTION` is set to 1 and a correctable error occurs in the LMB memory, as indicated by the `DCE` signal. An error can occur for all read accesses, and for byte and halfword write accesses.
- **Unaligned Exception:** For 32-bit MicroBlaze the unaligned exception is caused by a word access where the address to the data bus has any of the two least significant bits set, or a half-word access with the least significant bit set.

For 64-bit MicroBlaze the unaligned exception is caused by a long access where the address to the data bus has any of the three least significant bits set, a word access with any of the two least significant bits set, or a half-word access with the least significant bit set.
- **Divide Exception:** The divide exception is caused by an integer division (`idiv` or `idivu`) where the divisor is zero, or by a signed integer division (`idiv`) where overflow occurs (`-2147483648 / -1`).
- **FPU Exception:** An FPU exception is caused by an underflow, overflow, divide-by-zero, illegal operation, or denormalized operand occurring with a floating-point instruction.
 - Underflow occurs when the result is denormalized.
 - Overflow occurs when the result is not-a-number (NaN).
 - The divide-by-zero FPU exception is caused by the `rA` operand to `fdiv` being zero when `rB` is not infinite.
 - Illegal operation is caused by a signaling NaN operand or by illegal infinite or zero operand combinations.

- **Privileged Instruction Exception:** The Privileged Instruction exception is caused by an attempt to execute a privileged instruction in User Mode.
- **Stack Protection Violation Exception:** A Stack Protection Violation exception is caused by executing a load or store instruction using the stack pointer (register R1) as rA with an address outside the stack boundaries defined by the special Stack Low and Stack High registers, causing a stack overflow or a stack underflow.
- **Data Storage Exception:** The Data Storage exception is caused by an attempt to access data in memory that results in a memory-protection violation.
- **Instruction Storage Exception:** The Instruction Storage exception is caused by an attempt to access instructions in memory that results in a memory-protection violation.
- **Data TLB Miss Exception:** The Data TLB Miss exception is caused by an attempt to access data in memory, when a valid Translation Look-Aside Buffer entry is not present, and virtual protected mode is enabled.
- **Instruction TLB Miss Exception:** The Instruction TLB Miss exception is caused by an attempt to access instructions in memory, when a valid Translation Look-Aside Buffer entry is not present, and virtual protected mode is enabled.

Should an Instruction Bus Exception, Illegal Opcode Exception, or Data Bus Exception occur when `C_FAULT_TOLERANT` is set to 1, and an exception is in progress (that is MSR[EIP] set and MSR[EE] cleared), the pipeline is halted, and the external signal `MB_Error` is set.

Imprecise Exceptions

Normally all exceptions in MicroBlaze are precise, meaning that any instructions in the pipeline after the instruction causing an exception are invalidated, and have no effect.

When `C_IMPRECISE_EXCEPTIONS` is set to 1 (ECC) an Instruction Bus Exception or Data Bus Exception caused by ECC errors in LMB memory is not precise, meaning that a subsequent memory access instruction in the pipeline might be executed. If this behavior is acceptable, the maximum frequency can be improved by setting this parameter to 1.

Equivalent Pseudocode

```

ESR[DS] ← exception in delay slot
if ESR[DS] then
    BTR ← branch target PC
    if MMU exception then
        if branch preceded by IMM then
            r17 ← PC - 8
        else
            r17 ← PC - 4
    else
        r17 ← invalid value
else if MMU exception then
    if instruction preceded by IMM then
        r17 ← PC - 4
    else
        r17 ← PC
else
    r17 ← PC + 4
PC ← C_BASE_VECTORS + 0x20
MSR[EE] ← 0, MSR[EIP] ← 1
MSR[UMS] ← MSR[UM], MSR[UM] ← 0, MSR[VMS] ← MSR[VM], MSR[VM] ← 0
ESR[EC] ← exception specific value
ESR[ESS] ← exception specific value
EAR ← exception specific value
FSR ← exception specific value
Reservation ← 0

```

Breaks

There are two kinds of breaks:

- Hardware (external) breaks
- Software (internal) breaks

Hardware Breaks

Hardware breaks are performed by asserting the external break signal (that is, the `Ext_BRK` and `Ext_NM_BRK` input ports). On a break, the instruction in the execution stage completes while the instruction in the decode stage is replaced by a branch to the break vector (address `C_BASE_VECTORS + 0x18`).

The break return address (the PC associated with the instruction in the decode stage at the time of the break) is automatically loaded into general purpose register R16. MicroBlaze also sets the Break In Progress (BIP) flag in the Machine Status Register (MSR).

A normal hardware break (that is, the `Ext_BRK` input port) is only handled when `MSR[BIP]` and `MSR[EIP]` are set to 0 (that is, there is no break or exception in progress). The Break In Progress flag disables interrupts. A non-maskable break (that is, the `Ext_NM_BRK` input port) is always handled immediately.

The BIP bit in the MSR is automatically cleared when executing the `RTBD` instruction.

The `Ext_BRK` signal must be kept asserted until the break has occurred, and deasserted before the `RTBD` instruction is executed. The `Ext_NM_BRK` signal must only be asserted one clock cycle.

Software Breaks

To perform a software break, use the `brk` and `brki` instructions. Refer to [Chapter 5: MicroBlaze Instruction Set Architecture](#) for detailed information on software breaks.

As a special case, when `C_DEBUG_ENABLED` is greater than zero, and `brki rD, 0x18` is executed, a software breakpoint is signaled to the debugger; for example, the System Debugger (XSDB) tool, irrespective of the value of `C_BASE_VECTORS`. In this case the `BIP` bit in the `MSR` is not set.

Latency

The time it takes the MicroBlaze processor to enter a break service routine from the time the break occurs depends on the instruction currently in the execution stage and the latency to the memory storing the break vector.

Equivalent Pseudocode

```
r16 ← PC
PC ← C_BASE_VECTORS + 0x18
MSR[BIP] ← 1
MSR[UMS] ← MSR[UM], MSR[UM] ← 0, MSR[VMS] ← MSR[VM], MSR[VM] ← 0
Reservation ← 0
```

Interrupt

MicroBlaze supports one external interrupt source (connected to the Interrupt input port). The processor only reacts to interrupts if the Interrupt Enable (IE) bit in the Machine Status Register (MSR) is set to 1. On an interrupt, the instruction in the execution stage completes while the instruction in the decode stage is replaced by a branch to the interrupt vector. This is either address `C_BASE_VECTORS + 0x10`, or with low-latency interrupt mode, the address supplied by the Interrupt Controller.

The interrupt return address (the PC associated with the instruction in the decode stage at the time of the interrupt) is automatically loaded into general purpose register R14. In addition, the processor also disables future interrupts by clearing the IE bit in the MSR. The IE bit is automatically set again when executing the `RTID` instruction.

Interrupts are ignored by the processor if either of the break in progress (BIP) or exception in progress (EIP) bits in the MSR are set to 1.

By using the parameter `C_INTERRUPT_IS_EDGE`, the external interrupt can either be set to level-sensitive or edge-triggered:

- When using level-sensitive interrupts, the `Interrupt` input must remain set until MicroBlaze has taken the interrupt, and jumped to the interrupt vector. Software must acknowledge the interrupt at the source to clear it before returning from the interrupt handler. If not, the interrupt is taken again, as soon as interrupts are enabled when returning from the interrupt handler.
- When using edge-triggered interrupts, MicroBlaze detects and latches the `Interrupt` input edge, which means that the input only needs to be asserted one clock cycle. The interrupt input can remain asserted, but must be deasserted at least one clock cycle before a new interrupt can be detected. The latching of an edge-triggered interrupt is independent of the IE bit in MSR. Should an interrupt occur while the IE bit is 0, it will immediately be serviced when the IE bit is set to 1.

With periodic interrupt sources, such as the FIT Timer IP core, that do not have a method to clear the interrupt from software, it is recommended to use edge-triggered interrupts.

Low-latency Vectored Interrupt Mode

A low-latency vectored interrupt mode is available, which allows the Interrupt Controller to directly supply the interrupt vector for each individual interrupt (using the input port `Interrupt_Address`). The address of each fast interrupt handler must be passed to the Interrupt Controller when initializing the interrupt system. When a particular interrupt occurs, this address is supplied by the Interrupt Controller, which allows MicroBlaze to directly jump to the handler code.

With this mode, MicroBlaze also directly sends the appropriate interrupt acknowledge to the Interrupt Controller (using the `Interrupt_Ack` output port), although it is still the responsibility of the Interrupt Service Routine to acknowledge level sensitive interrupts at the source.

This information allows the Interrupt Controller to acknowledge interrupts appropriately, both for level-sensitive and edge-triggered interrupt.

To inform the Interrupt Controller of the interrupt handling events, `Interrupt_Ack` is set to:

- 01: When MicroBlaze jumps to the interrupt handler code
- 10: When the RTID instruction is executed to return from interrupt
- 11: When MSR[IE] is changed from 0 to 1, which enables interrupts again

The `Interrupt_Ack` output port is active during one clock cycle, and is then reset to 00.

Latency

The time it takes MicroBlaze to enter an Interrupt Service Routine (ISR) from the time an interrupt occurs, depends on the configuration of the processor and the latency of the memory controller storing the interrupt vectors. If MicroBlaze is configured to have a hardware divider, the largest latency happens when an interrupt occurs during the execution of a division instruction.

With low-latency vectored interrupt mode, the time to enter the ISR is significantly reduced, because the interrupt vector for each individual interrupt is directly supplied by the Interrupt Controller. With compiler support for fast interrupts, there is no need for a common ISR at all. Instead, the ISR for each individual interrupt will be directly called, and the compiler takes care of saving and restoring registers used by the ISR.

Equivalent Pseudocode

```
r14 ← PC
if C_USE_INTERRUPT = 2
    PC ← Interrupt_Address
    Interrupt_Ack ← 01
else
    PC ← C_BASE_VECTORS + 0x10
MSR[IE] ← 0
MSR[UMS] ← MSR[UM], MSR[UM] ← 0, MSR[VMS] ← MSR[VM], MSR[VM] ← 0
Reservation ← 0
```

User Vector (Exception)

The user exception vector is located at address 0x8. A user exception is caused by inserting a 'BRALID Rx,0x8' instruction in the software flow. Although RX could be any general purpose register, AMD recommends using R15 for storing the user exception return address, and to use the RTSD instruction to return from the user exception handler.

Pseudocode

```
rx ← PC
PC ← C_BASE_VECTORS + 0x8
MSR[UMS] ← MSR[UM], MSR[UM] ← 0, MSR[VMS] ← MSR[VM], MSR[VM] ← 0
Reservation ← 0
```

Instruction Cache

Overview

MicroBlaze can be used with an optional instruction cache for improved performance when executing code that resides outside the LMB address range.

- Direct mapped (1-way associative)
- User selectable cacheable memory address range
- Configurable cache and tag size
- Caching over AXI4 interface (`M_AXI_IC`)
- Option to use 4, 8, or 16 word cache-line
- Cache on and off controlled using a bit in the MSR
- Optional WIC instruction to invalidate instruction cache lines
- Optional stream buffers to improve performance by speculatively prefetching instructions
- Optional victim cache to improve performance by saving evicted cache lines
- Optional parity protection that invalidates cache lines if a Block RAM bit error is detected
- Optional data width selection to either use 32 bits, an entire cache line, or 512 bits

General Instruction Cache Functionality

When the instruction cache is used, the memory address space is split into two segments: a cacheable segment and a non-cacheable segment. The cacheable segment is determined by two parameters: `C_ICACHE_BASEADDR` and `C_ICACHE_HIGHADDR`. All addresses within this range correspond to the cacheable address segment. All other addresses are non-cacheable.

The cacheable segment size must be 2^N , where N is a positive integer. The range specified by `C_ICACHE_BASEADDR` and `C_ICACHE_HIGHADDR` must comprise a complete power-of-two range, such that $\text{range} = 2^N$ and the N least significant bits of `C_ICACHE_BASEADDR` must be zero.

The cacheable instruction address consists of two parts: the cache address, and the tag address. The MicroBlaze instruction cache can be configured from 64 bytes to 64 kB. This corresponds to a cache address of between 6 and 16 bits. The tag address together with the cache address should match the full address of cacheable memory.

When selecting cache sizes below 2 kB, distributed RAM is used to implement the Tag RAM and Instruction RAM. Distributed RAM is always used to implement the Tag RAM, when setting the parameter `C_ICACHE_FORCE_TAG_LUTRAM` to 1. This parameter is only available with cache size 8 kB and less for 4 word cache-lines, with 16 kB and less for 8 word cache-lines, and with 32 kB and less for 16 word cache-lines.

For example: in a 32-bit MicroBlaze configured with `C_ICACHE_BASEADDR=0x00300000`, `C_ICACHE_HIGHADDR=0x0030ffff`, `C_CACHE_BYTE_SIZE=4096`, `C_ICACHE_LINE_LEN=8`, and `C_ICACHE_FORCE_TAG_LUTRAM=0`; the cacheable memory of 64 kB uses 16 bits of byte address, and the 4 kB cache uses 12 bits of byte address, thus the required address tag width is: $16-12=4$ bits. The total number of block RAM primitives required in this configuration is: 2 RAMB16 for storing the 1024 instruction words, and 1 RAMB16 for 128 cache line entries, each consisting of: 4 bits of tag, 8 word-valid bits, 1 line-valid bit. In total 3 RAMB16 primitives.

The following figure shows the organization of Instruction Cache.

Figure 25: Instruction Cache Organization

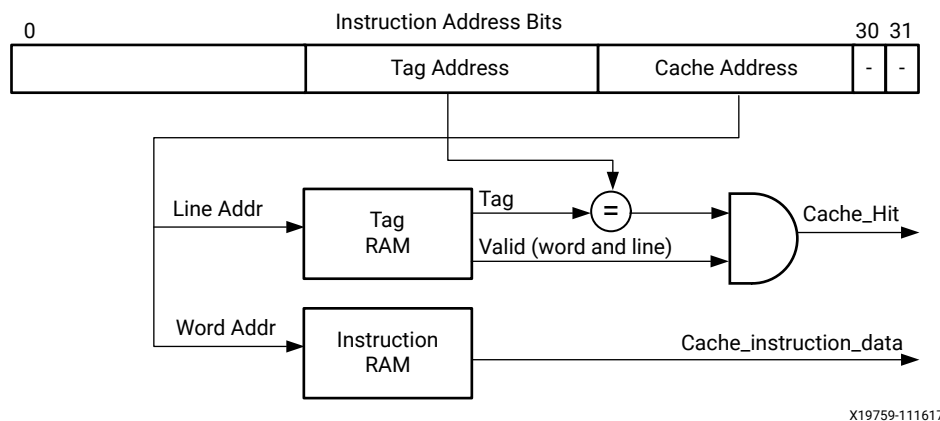

X19759-111617

Instruction Cache Operation

For every instruction fetched, the instruction cache detects if the instruction address belongs to the cacheable segment. If the address is non-cacheable, the cache controller ignores the instruction and lets the `M_AXI_IP` or LMB complete the request. If the address is cacheable, a lookup is performed on the tag memory to check if the requested address is currently cached. The lookup is successful if: the word and line valid bits are set, and the tag address matches the instruction address tag segment. On a cache miss, the cache controller requests the new instruction over the instruction AXI4 interface (`M_AXI_IC`), and waits for the memory controller to return the associated cache line.

`C_ICACHE_DATA_WIDTH` determines the bus data width, either 32 bits, an entire cache line (128, 256, or 512 bits), or 512 bits.

When `C_FAULT_TOLERANT` is set to 1, a cache miss also occurs if a parity error is detected in a tag or instruction Block RAM.

The instruction cache issues burst accesses for the AXI4 interface when 32-bit data width is used, otherwise single accesses are used.

Stream Buffers

When stream buffers are enabled, by setting the parameter `C_ICACHE_STREAMS` to 1, the cache will speculatively fetch cache lines in advance in sequence following the last requested address, until the stream buffer is full.

The stream buffer can hold up to two cache lines. Should the processor subsequently request instructions from a cache line prefetched by the stream buffer, which occurs in linear code, they are immediately available.

The stream buffer often improves performance, because the processor generally has to spend less time waiting for instructions to be fetched from memory.

`C_ICACHE_DATA_WIDTH` determines the amount of data transferred from the stream buffer each clock cycle, either 32 bits or an entire cache line.

To be able to use instruction cache stream buffers, area optimization must not be enabled.

Victim Cache

The victim cache is enabled by setting the parameter `C_ICACHE_VICTIMS` to 2, 4, or 8. This defines the number of cache lines that can be stored in the victim cache. Whenever a cache line is evicted from the cache, it is saved in the victim cache. By saving the most recent lines they can be fetched much faster, should the processor request them, thereby improving performance. If the victim cache is not used, all evicted cache lines must be read from memory again when they are needed.

`C_ICACHE_DATA_WIDTH` determines the amount of data transferred from/to the victim cache each clock cycle, either 32 bits or an entire cache line.

Note: To be able to use the victim cache, area optimization must not be enabled.

Instruction Cache Software Support

MSR Bit

The ICE bit in the MSR provides software control to enable and disable caches.

The contents of the cache are preserved by default when the cache is disabled. You can invalidate cache lines using the WIC instruction or using the hardware debug logic of MicroBlaze.

WIC Instruction

The optional WIC instruction (`C_ALLOW_ICACHE_WR=1`) is used to invalidate cache lines in the instruction cache from an application. For a detailed description, see [Chapter 5: MicroBlaze Instruction Set Architecture](#).

The WIC instruction can also be used together with parity protection to periodically invalidate entries the cache, to avoid accumulating errors.

Data Cache

Overview

The MicroBlaze processor can be used with an optional data cache for improved performance. The cached memory range must not include addresses in the LMB address range. The data cache has the following features:

- Direct mapped (1-way associative)
- Write-through or Write-back
- User selectable cacheable memory address range
- Configurable cache size and tag size
- Caching over AXI4 interface (`M_AXI_DC`)
- Option to use 4, 8, or 16 word cache-lines
- Cache on and off controlled using a bit in the MSR
- Optional WDC instruction to invalidate or flush data cache lines
- Optional victim cache with write-back to improve performance by saving evicted cache lines
- Optional parity protection for write-through cache that invalidates cache lines if a Block RAM bit error is detected
- Optional data width selection to either use 32 bits, an entire cache line, or 512 bits

General Data Cache Functionality

When the data cache is used, the memory address space is split into two segments: a cacheable segment and a non-cacheable segment. The cacheable area is determined by two parameters: `C_DCACHE_BASEADDR` and `C_DCACHE_HIGHADDR`. All addresses within this range correspond to the cacheable address space. All other addresses are non-cacheable.

The cacheable segment size must be 2^N , where N is a positive integer. The range specified by `C_DCACHE_BASEADDR` and `C_DCACHE_HIGHADDR` must comprise a complete power-of-two range, such that $\text{range} = 2^N$ and the N least significant bits of `C_DCACHE_BASEADDR` must be zero.

The following figure shows the Data Cache organization.

Figure 26: Data Cache Organization

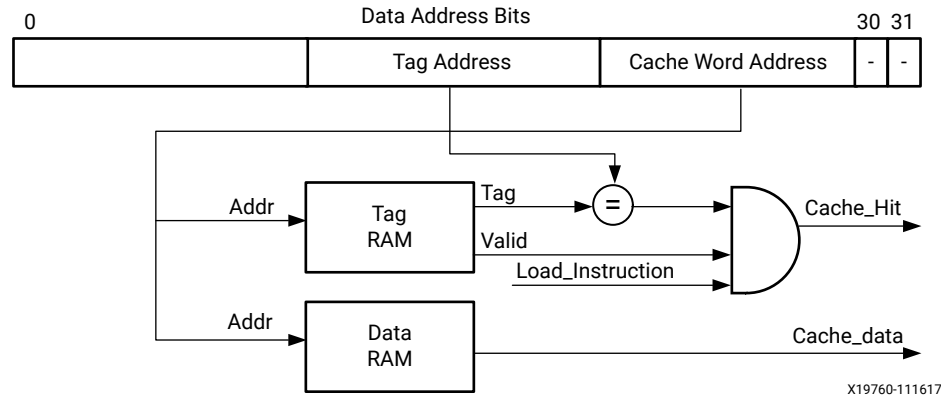

The cacheable data address consists of two parts: the cache address, and the tag address. The MicroBlaze data cache can be configured from 64 bytes to 64 kB. This corresponds to a cache address of between 6 and 16 bits. The tag address together with the cache address should match the full address of cacheable memory. When selecting cache sizes below 2 kB, distributed RAM is used to implement the Tag RAM and Data RAM, except that block RAM is always used for the Data RAM when `C_AREA_OPTIMIZED` is set to 1 (Area) and `C_DCACHE_USE_WRITEBACK` is not set. Distributed RAM is always used to implement the Tag RAM, when setting the parameter `C_DCACHE_FORCE_TAG_LUTRAM` to 1. This parameter is only available with cache size 8 kB and less for 4 word cache-lines, with 16 kB and less for 8 word cache-lines, and with 32 kB and less for 16 word cache-lines.

For example, in a 32-bit MicroBlaze configured with `C_DCACHE_BASEADDR=0x00400000`, `C_DCACHE_HIGHADDR=0x00403fff`, `C_DCACHE_BYTE_SIZE=2048`, `C_DCACHE_LINE_LEN=4`, and `C_DCACHE_FORCE_TAG_LUTRAM=0`; the cacheable memory of 16 kB uses 14 bits of byte address, and the 2 kB cache uses 11 bits of byte address, thus the required address tag width is $14-11=3$ bits. The total number of block RAM primitives required in this configuration is 1 RAMB16 for storing the 512 data words, and 1 RAMB16 for 128 cache line entries, each consisting of 3 bits of tag, 4 word-valid bits, 1 line-valid bit. In total, 2 RAMB16 primitives.

Data Cache Operation

The caching policy used by the MicroBlaze data cache, write-back or write-through, is determined by the parameter `C_DCACHE_USE_WRITEBACK`. When this parameter is set, a write-back protocol is implemented; otherwise write-through is implemented.

However, when configured with an MMU (`C_USE_MMU > 1`, `C_AREA_OPTIMIZED = 0` (Performance) or 2 (Frequency), `C_DCACHE_USE_WRITEBACK = 1`), the caching policy in virtual mode is determined by the `W` storage attribute in the TLB entry, whereas write-back is used in real mode.

With the write-back protocol, a store to an address within the cacheable range always updates the cached data. If the target address word is not in the cache (that is, the access is a cache miss), and the location in the cache contains data that has not yet been written to memory (the cache location is dirty), the old data is written over the data AXI4 interface (`M_AXI_DC`) to external memory before updating the cache with the new data. If only a single word needs to be written, a single word write is used, otherwise a burst write is used. For byte or halfword stores, in case of a cache miss, the address is first requested over the data AXI4 interface, while a word store only updates the cache.

With the write-through protocol, a store to an address within the cacheable range generates an equivalent byte, halfword, or word write over the data AXI4 interface to external memory. The write also updates the cached data if the target address word is in the cache (that is, the write is a cache hit). A write cache-miss does not load the associated cache line into the cache.

Provided that the cache is enabled a load from an address within the cacheable range triggers a check to determine if the requested data is currently cached. If it is (that is, on a cache hit) the requested data is retrieved from the cache. If not (that is, on a cache miss) the address is requested over the data AXI4 interface using a burst read, and the processor pipeline stalls until the cache line associated to the requested address is returned from the external memory controller.

The parameter `C_DCACHE_DATA_WIDTH` determines the bus data width, either 32 bits, an entire cache line (128, 256, or 512 bits), or 512 bits.

When `C_FAULT_TOLERANT` is set to 1 and write-through protocol is used, a cache miss also occurs if a parity error is detected in the tag or data block RAM.

The following table summarizes all types of accesses issued by the data cache AXI4 interface.

Table 41: Data Cache Interface Accesses

Policy	State	Direction	Access Type
Write-through	Cache Enabled	Read	Burst for 32-bit interface non-exclusive access and exclusive access with ACE enabled, single access otherwise
		Write	Single access
	Cache Disabled	Read	Burst for 32-bit interface exclusive access with ACE enabled, single access otherwise
		Write	Single access
Write-back	Cache Enabled	Read	Burst for 32-bit interface, single access otherwise
		Write	Burst for 32-bit interface cache lines with more than one valid word, a single access otherwise
	Cache Disabled	Read	Burst for 32-bit interface non-exclusive access, discarding all but the desired data, a single access otherwise
		Write	Single access

Victim Cache

The victim cache is enabled by setting the parameter `C_DCACHE_VICTIMS` to 2, 4 or 8. This defines the number of cache lines that can be stored in the victim cache. Whenever a complete cache line is evicted from the cache, it is saved in the victim cache. By saving the most recent lines they can be fetched much faster, should the processor request them, thereby improving performance. If the victim cache is not used, all evicted cache lines must be read from memory again when they are needed.

With the AXI4 interface, `C_DCACHE_DATA_WIDTH` determines the amount of data transferred from/to the victim cache each clock cycle, either 32 bits or an entire cache line.

Note: To be able to use the victim cache, write-back must be enabled and area optimization must not be enabled.

Data Cache Software Support

MSR Bit

The DCE bit in the MSR controls whether or not the cache is enabled. When disabling caches you must ensure that all the prior writes within the cacheable range are completed in external memory before reading back over `M_AXI_DP`. This can be done by writing to a semaphore immediately before turning off caches, and then in a loop poll until it has been written. The contents of the cache are preserved when the cache is disabled.

WDC Instruction

The optional WDC instruction (C_ALLOW_DCACHE_WR=1) is used to invalidate or flush cache lines in the data cache from an application. For a detailed description, refer to [Chapter 5: MicroBlaze Instruction Set Architecture](#).

The WDC instruction can also be used together with parity protection to periodically invalidate entries the cache, to avoid accumulating errors.

With an external L2 cache, such as the System Cache, connected to MicroBlaze using the ACE interface, external cache invalidate or flush can be performed with WDC. See the *System Cache LogiCORE IP Product Guide* ([PG118](#)) for more information on the System Cache.

Floating-Point Unit (FPU)

Overview

The MicroBlaze floating-point unit is based on the IEEE 754-1985 standard.

- Uses IEEE 754 single precision floating-point format, and double precision format with 64-bit MicroBlaze, including definitions for infinity, not-a-number (NaN), and zero
- Supports addition, subtraction, multiplication, division, comparison, conversion, and square root instructions
- Implements round-to-nearest mode
- Generates sticky status bits for: underflow, overflow, divide-by-zero and invalid operation

For improved performance, the following non-standard simplifications are made:

- Denormalized ¹ operands are not supported. A hardware floating-point operation on a denormalized number returns a quiet NaN and sets the sticky denormalized operand error bit in FSR; see [Floating-Point Status Register](#).
- A denormalized result is stored as a signed 0 with the underflow bit set in FSR. This method is commonly referred to as Flush-to-Zero (FTZ)
- An operation on a quiet NaN returns the fixed NaN: 0xFFC00000 for single precision or 0xFFF8000000000000 for double precision, rather than one of the NaN operands
- Overflow as a result of a floating-point operation always returns signed ∞ .

Note:

1. Numbers that are so close to 0, that they cannot be represented with full precision, that is, any number n that falls in the following ranges for single precision: $(1.17549 \cdot 10^{-38} > n > 0)$, or $(0 > n > -1.17549 \cdot 10^{-38})$, and the following ranges for double precision: $(5.562684646268 \cdot 10^{-309} > n > 0)$, or $(0 > n > -5.562684646268 \cdot 10^{-309})$

Format

Single Precision

An IEEE 754 single precision floating-point number is composed of the following three fields:

1. 1-bit sign
2. 2.8-bit biased exponent
3. 3.23-bit fraction (a.k.a. mantissa or significand)

The fields are stored in a 32 bit word as defined in the following figure:

Figure 27: IEEE 754 Single Precision Format

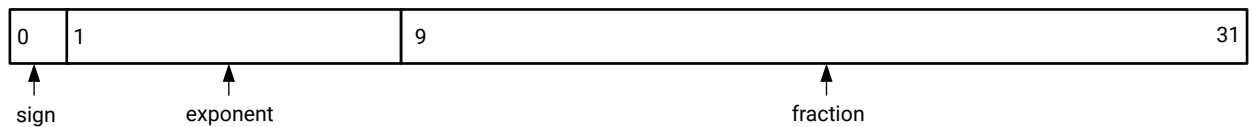

X19761-111617

The value of a floating-point number v in MicroBlaze has the following interpretation:

1. If $exponent = 255$ and $fraction \neq 0$, then $v = NaN$, regardless of the $sign$ bit
2. If $exponent = 255$ and $fraction = 0$, then $v = (-1)^{sign} * \infty$
3. If $0 < exponent < 255$, then $v = (-1)^{sign} * 2^{(exponent-127)} * (1.fraction)$
4. If $exponent = 0$ and $fraction \neq 0$, then $v = (-1)^{sign} * 2^{-126} * (0.fraction)$
5. If $exponent = 0$ and $fraction = 0$, then $v = (-1)^{sign} * 0$

For practical purposes only 3 and 5 are useful, while the others all represent either an error or numbers that can no longer be represented with full precision in a 32 bit format.

Double Precision

An IEEE 754 double precision floating point number is composed of the following three fields:

1. 1-bit sign
2. 11-bit biased exponent
3. 52-bit fraction (a.k.a. mantissa or significand)

The fields are stored in a 64 bit long as defined in the following figure:

Figure 28: IEEE 754 Double Precision Format

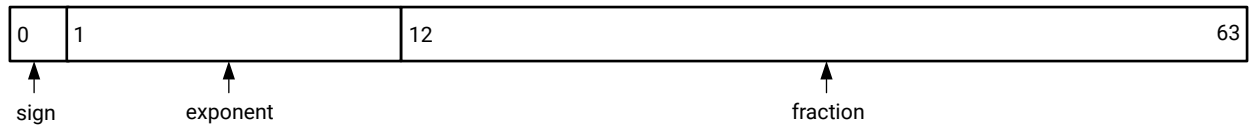

X20091-112317

The value of a floating point number v in MicroBlaze has the following interpretation:

1. If $exponent = 2047$ and $fraction \neq 0$, then $v = NaN$, regardless of the $sign$ bit
2. If $exponent = 2047$ and $fraction = 0$, then $v = (-1)^{sign} * \infty$
3. If $0 < exponent < 2047$, then $v = (-1)^{sign} * 2^{(exponent-1023)} * (1.fraction)$
4. If $exponent = 0$ and $fraction \neq 0$, then $v = (-1)^{sign} * 2^{-1022} * (0.fraction)$
5. If $exponent = 0$ and $fraction = 0$, then $v = (-1)^{sign} * 0$

For practical purposes only 3 and 5 are useful, while the others all represent either an error or numbers that can no longer be represented with full precision in a 64 bit format.

Rounding

The MicroBlaze FPU only implements the default rounding mode, “Round-to-nearest”, specified in IEEE 754. By definition, the result of any floating-point operation should return the nearest single precision value to the infinitely precise result. If the two nearest representable values are equally near, then the one with its least significant bit zero is returned.

Operations

All MicroBlaze FPU operations use the processors general purpose registers rather than a dedicated floating-point register file, see [General Purpose Registers](#).

Arithmetic

The FPU implements the following floating point operations, where the double operations are available with 64-bit MicroBlaze:

- addition, fadd and dadd
- subtraction, frsub and drsub
- multiplication, fmul and dmul
- division, fdiv and ddiv
- square root, fsqrt and dsqrt (available if `C_USE_FPU = 2, EXTENDED`)

Comparison

The FPU implements the following floating point comparisons, where the double operations are available with 64-bit MicroBlaze:

- compare less-than, `fcmp.lt` and `dcmp.lt`
- compare equal, `fcmp.eq` and `dcmp.eq`
- compare less-or-equal, `fcmp.le` and `dcmp.le`
- compare greater-than, `fcmp.gt` and `dcmp.gt`
- compare not-equal, `fcmp.ne` and `dcmp.ne`
- compare greater-or-equal, `fcmp.ge` and `dcmp.ge`
- compare unordered, `fcmp.un` and `dcmp.un` (used for NaN)

Conversion

The FPU implements the following conversions (available if `C_USE_FPU = 2, EXTENDED`), where the double operations are available with 64-bit MicroBlaze:

- convert from signed integer to single floating point, `flt`
- convert from single floating point to signed integer, `fint`
- convert from signed long to floating point, `dbl`
- convert from double floating point to signed long, `dlong`

Exceptions

The floating-point unit uses the regular hardware exception mechanism in MicroBlaze. When enabled, exceptions are thrown for all the IEEE standard conditions: underflow, overflow, divide-by-zero, and illegal operation, as well as for the MicroBlaze specific exception: denormalized operand error.

A floating-point exception inhibits the write to the destination register (Rd). This allows a floating-point exception handler to operate on the uncorrupted register file.

Software Support

The AMD Vitis™ unified software platform compiler system, based on GCC, provides support for the floating-point Unit compliant with the MicroBlaze API. Compiler flags are automatically added to the GCC command line based on the type of FPU present in the system, when using Vitis unified software platform.

All double-precision operations are emulated in software with 32-bit MicroBlaze. Be aware that the `xil_printf()` function does not support floating-point output. The standard C library `printf()` and related functions do support floating-point output, but will increase the program code size.

Libraries and Binary Compatibility

The Vitis unified software platform compiler system only includes software floating-point C runtime libraries. To take advantage of the hardware FPU, the libraries must be recompiled with the appropriate compiler switches.

For all cases where separate compilation is used, it is very important that you ensure the consistency of FPU compiler flags throughout the build.

Operator Latencies

The latencies of the various operations supported by the FPU are listed in [Chapter 5: MicroBlaze Instruction Set Architecture](#). The FPU instructions are not pipelined, so only one operation can be ongoing at any time.

C Language Programming

To gain maximum benefit from the FPU without low-level assembly-language programming, it is important to consider how the C compiler will interpret your source code. Very often the same algorithm can be expressed in many different ways, and some are more efficient than others.

Immediate Constants

Floating-point constants in C are double-precision by default. When using a single-precision FPU, careless coding could result in double-precision software emulation routines being used instead of the native single-precision instructions. To avoid this, explicitly specify (by cast or suffix) that immediate constants in your arithmetic expressions are single-precision values.

For example:

```
float x = 0.0;
...
x += (float)1.0;           /* float addition */
x += 1.0F;                /* alternative to above */
x += 1.0;                 /* warning - uses double addition! */
```

Note: The GNU C compiler can be instructed to treat all floating-point constants as single-precision (contrary to the ANSI C standard) by supplying the compiler flag `-fsingle-precision-constants`.

Avoiding Unnecessary Casting

While conversions between floating-point and integer formats are supported in hardware by the FPU, when `C_USE_FPU` is set to 2 (Extended), it is still best to avoid them when possible.

The following not-recommended example calculates the sum of squares of the integers from 1 to 10 using floating-point representation:

```
float sum, t;
int i;
sum = 0.0f;
for (i = 1; i <= 10; i++) {
    t = (float)i;
    sum += t * t;
}
```

The above code requires a cast from an integer to a float on each loop iteration. This can be rewritten as:

```
float sum, t;
int i;
t = sum = 0.0f;
for(i = 1; i <= 10; i++) {
    t += 1.0f;
    sum += t * t;
}
```

Note: The compiler is not at liberty to perform this optimization in general, as the two code fragments above might give different results in some cases (for example, very large t).

Using Square Root Runtime Library Function

The standard C runtime math library functions operate using double-precision arithmetic. When using a single-precision FPU, calls to the square root functions (`sqrt()`) result in inefficient emulation routines being used instead of FPU instructions:

```
#include <math.h>
...
float x=-1.0F;
...
x = sqrt(x); /* uses double precision */
```

Here the `math.h` header is included to avoid a warning message from the compiler.

When used with single-precision data types, the result is a cast to double, a runtime library call is made (which does not use the FPU) and then a truncation back to float is performed.

The solution is to use the non-ANSI function `sqrtf()` instead, which operates using single precision and can be carried out using the FPU. For example:

```
#include <math.h>
...
float x=-1.0F;
...
x = sqrtf(x); /* uses single precision */
```

Note: When compiling this code, the compiler flag `-fno-math-errno` (in addition to `-mhard-float` and `-mx1-float-sqrt`) must be used, to ensure that the compiler does not generate unnecessary code to handle error conditions by updating the `errno` variable.

Stream Link Interfaces

MicroBlaze can be configured with up to 16 AXI4-Stream interfaces, each consisting of one input and one output port. The channels are dedicated uni-directional point-to-point data streaming interfaces.

For detailed information on the AXI4-Stream interface, refer to the *AMBA AXI4-Stream Protocol Specification (ARM IHI 0051A)* document.

The interfaces on MicroBlaze are 32 bits wide. A separate bit indicates whether the sent/received word is of control or data type. The get instruction in the MicroBlaze ISA is used to transfer information from a port to a general purpose register. The put instruction is used to transfer data in the opposite direction. Both instructions come in 4 flavors: blocking data, non-blocking data, blocking control, and non-blocking control. For a detailed description of the get and put instructions, see [Chapter 5: MicroBlaze Instruction Set Architecture](#).

Hardware Acceleration

Each link provides a low latency dedicated interface to the processor pipeline. Thus they are ideal for extending the processors execution unit with custom hardware accelerators. A simple example is illustrated in the following figure. The code uses RFSLx to indicate the used link.

Figure 29: Stream Link Used with HW Accelerated Function

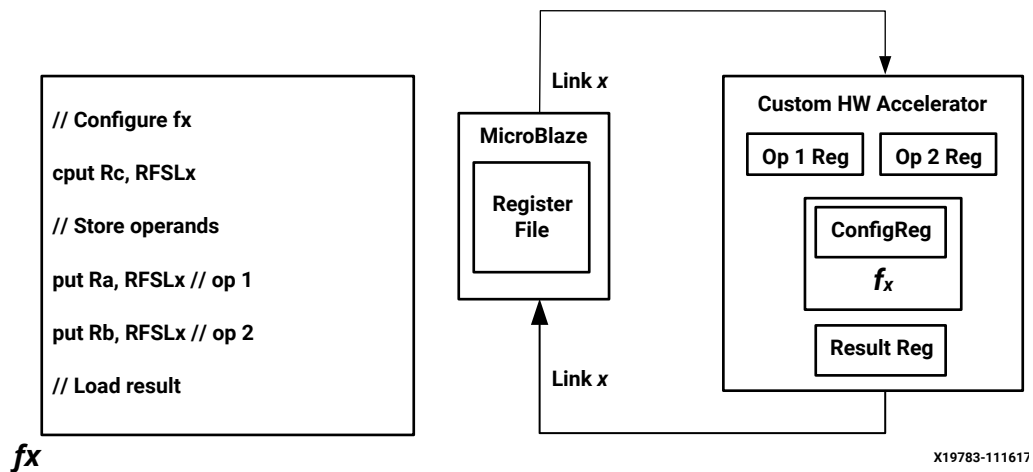

This method is similar to extending the ISA with custom instructions, but has the benefit of not making the overall speed of the processor pipeline dependent on the custom function. Also, there are no additional requirements on the software tool chain associated with this type of functional extension.

Debug and Trace

Debug Overview

MicroBlaze features a debug interface to support JTAG based software debugging tools (commonly known as BDM or Background Debug Mode debuggers) like the System Debugger (XSDB) tool. The debug interface is designed to be connected to the MicroBlaze Debug Module (MDM) core, which interfaces with the JTAG port of FPGAs. Multiple MicroBlaze instances can be interfaced with a single MDM to enable multiprocessor debugging.

To be able to download programs, set software breakpoints and disassemble code, the instruction and data memory ranges must overlap, and use the same physical memory.

Debug registers are accessed using the debug interface, and are not directly visible to software running on the processor, unless the MDM is configured to enable software access to user-accessible debug registers. The debug interface can either use JTAG serial access or AXI4-Lite parallel access, controlled by the parameter `C_DEBUG_INTERFACE`.

See the *MicroBlaze Debug Module (MDM) LogiCORE IP Product Guide (PG115)* for a detailed description of the MDM features.

The basic debugging features enabled by setting `C_DEBUG_ENABLED` to 1 (Basic) include:

- Configurable number of hardware breakpoints and watchpoints and unlimited software breakpoints
- External processor control enables debug tools to stop, reset, and single step MicroBlaze
- Read from and write to: memory, general purpose registers, and special purpose register, except EAR, EDR, ESR, BTR, and PVR0 - PVR12, which can only be read
- Support for multiple processors

The extended debugging features enabled by setting `C_DEBUG_ENABLED` to 2 (Extended) include:

- Configurable number of performance monitoring event and latency counters
- Program Trace:
 - Embedded program trace with configurable trace buffer size
 - External program trace for multiple processors, provided by the MDM
- Non-intrusive profiling support with configurable profiling buffer size
- Cross trigger support between multiple processors, and external cross trigger inputs and outputs, provided by the MDM

Performance Monitoring

With extended debugging, MicroBlaze provides performance monitoring counters to count various events and to measure latency during program execution. The number of event counters and latency counters can be configured with `C_DEBUG_EVENT_COUNTERS` and `C_DEBUG_LATENCY_COUNTERS` respectively, and the counter width can be set to 32, 48, or 64 bits with `C_DEBUG_COUNTER_WIDTH`. With the default configuration, the counter width is set to 32 bits and there are five event counters and one latency counter.

An event counter simply counts the number of times a certain event has occurred, whereas a latency counter provides the following information:

- Number of times the event has occurred (N)
- The sum of each event latency measured by counting clock cycles from the event starts until it finishes (ΣL), used to calculate the mean latency
- The sum of each event latency squared (ΣL^2), used to calculate the latency standard deviation
- The minimum, shortest, measured latency for all events (L_{min})
- The maximum, longest, measured latency for all events (L_{max})

The mean latency (μ) is calculated by the following formula:

Equation 1: Mean Latency

$$\mu = \frac{\Sigma L}{N}$$

The standard deviation (σ) of the latency is calculated by the following formula:

Equation 2: Standard Deviation of Latency

$$\sigma = \frac{\sqrt{N\Sigma L^2 - (\Sigma L)^2}}{N}$$

Counting can be started or stopped using the Performance Counter Command Register or by cross trigger events (see [Table 63: MicroBlaze Cross Trigger Actions](#)).

When configuring, reading or writing counters, they are accessed sequentially through the performance counter registers. After every access the selected counter item is incremented.

All counters are sampled simultaneously for reading using the Performance Counter Command Register. This can be done while counting, or after counting has been stopped.

When an event counter reaches its maximum value, the overflow status bit is set, and the external interrupt signal `Dbg_Intr` is set to one. The interrupt signal is reset to zero by clearing the counters using the Performance Counter Command Register.

By using one of the event counters to count number of clock cycles, and initializing this counter to overflow after a predetermined sampling interval, the external interrupt can be used to periodically sample the performance counters.

The available events are described in [Table 42: MicroBlaze Performance Monitoring Events](#), listed in numerical order.

A typical procedure to follow when initializing and using the performance monitoring counters is delineated in the steps below.

1. Initialize the events to be monitored:
 - Use the [Performance Counter Command Register](#) to reset the selected counter to the first counter, by setting the Reset bit.
 - Write the desired event numbers for all counters in order, using the [Performance Counter Control Register](#). With the default configuration this means writing the register five times for the event counters and then once for the latency counter.
2. Clear all counters and start monitoring using the Performance Command Register, by setting the Clear and Start bits.
3. Run the program or function to be monitored.
4. Sample counters and stop monitoring using the Performance Command Register, by setting the Sample and Stop bits.
5. Read the results from all counters:
 - Use the Performance Command Register to reset the selected counter to the first counter, by setting the Reset bit.
 - Read the status for all counters in order, using the [Performance Counter Status Register](#). With the default configuration this means reading the register five times for the event counters and then once for the latency counter. Ensure that the result is valid by checking that the overflow and full bits are not set.
 - Use the Performance Command Register to reset the selected counter to the first counter, by setting the Reset bit.
 - Read the counter items for all counters in order, using the [Performance Counter Data Read Register](#). With the default configuration this means reading the register five times for the event counters and then four times for the latency counter as described in [Performance Counter Data Read Register](#).
6. Calculate the final results, depending on the measured events, for example:
 - Use the formulas above to determine the mean latency and standard deviation for any measured latency.
 - The clock cycles per instruction (CPI) can be calculated by E_{30} / E_0 .
 - The instruction and data cache hit rates can be calculated by E_{11} / E_{10} and E_{47} / E_{46} .

- The instruction cache miss latency is determined by $(E_{60}(\Sigma L) - E_{60}(N)) / (E_{10} - E_{11})$, and equivalent formulas can be used to determine the data cache read and write miss latencies.
- The ratio of floating-point instructions in a program is E_{29}/E_0 .

Table 42: MicroBlaze Performance Monitoring Events

Event	Description	Event	Description
Event Counter Events			
0	Any valid instruction executed	29	Floating-point (<i>fadd</i> , ..., <i>fsqrt</i>)
1	Load word (<i>lw</i> , <i>lwi</i> , <i>lwx</i>) executed	30	Number of clock cycles
2	Load halfword (<i>lhu</i> , <i>lhui</i>) executed	31	Immediate (<i>imm</i>) executed
3	Load byte (<i>lbu</i> , <i>lbui</i>) executed	32	Pattern compare (<i>pcmpbf</i> , <i>pcmpeq</i> , <i>pcmpne</i>)
4	Store word (<i>sw</i> , <i>swi</i> , <i>swx</i>) executed	33	Sign extend instructions (<i>sext8</i> , <i>sext16</i>) executed
5	Store halfword (<i>sh</i> , <i>shi</i>) executed	34	Instruction cache invalidate (<i>wic</i>) executed
6	Store byte (<i>sb</i> , <i>sbi</i>) executed	35	Data cache invalidate or flush (<i>wdc</i>) executed
7	Unconditional branch (<i>br</i> , <i>bri</i> , <i>brk</i> , <i>brki</i>) executed	36	Machine status instructions (<i>msrset</i> , <i>msrclr</i>)
8	Taken conditional branch (<i>beq</i> , ..., <i>bnei</i>) executed	37	Unconditional branch with delay slot executed
9	Not taken conditional branch (<i>beq</i> , ..., <i>bnei</i>) executed	38	Taken conditional branch with delay slot executed
10	Data request from instruction cache	39	Not taken conditional branch with delay slot
11	Hit in instruction cache	40	Delay slot with no operation instruction executed
12	Read data requested from data cache	41	Load instruction (<i>lbu</i> , ..., <i>lwx</i>) executed
13	Read data hit in data cache	42	Store instruction (<i>sb</i> , ..., <i>swx</i>) executed
14	Write data request to data cache	43	MMU data access request
15	Write data hit in data cache	44	Conditional branch (<i>beq</i> , ..., <i>bnei</i>) executed
16	Load (<i>lbu</i> , ..., <i>lwx</i>) with r1 as operand executed	45	Branch (<i>br</i> , <i>bri</i> , <i>brk</i> , <i>brki</i> , <i>beq</i> , ..., <i>bnei</i>) executed
17	Store (<i>sb</i> , ..., <i>swx</i>) with r1 as operand executed	46	Read or write data request from/to data cache
18	Logical operation (<i>and</i> , <i>andn</i> , <i>or</i> , <i>xor</i>) executed	47	Read or write data cache hit
19	Arithmetic operation (<i>add</i> , <i>idiv</i> , <i>mul</i> , <i>rsub</i>) executed	48	MMU exception taken
20	Multiply operation (<i>mul</i> , <i>mulh</i> , <i>mulhu</i> , <i>mulhsu</i> , <i>muli</i>)	49	MMU instruction side exception taken
21	Barrel shifter operation (<i>bsrl</i> , <i>bsra</i> , <i>bsll</i>) executed	50	MMU data side exception taken
22	Shift operation (<i>sra</i> , <i>src</i> , <i>srl</i>) executed	51	Pipeline stalled
23	Exception taken	52	Branch target cache hit for a branch or return
24	Interrupt occurred	53	MMU instruction side access request

Table 42: MicroBlaze Performance Monitoring Events (cont'd)

Event	Description	Event	Description
25	Pipeline stalled due to operand fetch stage (OF)	54	MMU instruction TLB (ITLB) hit
26	Pipeline stalled due to execute stage (EX)	55	MMU data TLB (DTLB) hit
27	Pipeline stalled due to memory stage (MEM)	56	MMU unified TLB (UTLB) hit
28	Integer divide (<code>idiv</code> , <code>idivu</code>) executed		
Latency and Event Counter events			
57	Interrupt latency from input to interrupt vector	61	MMU address lookup latency
58	Data cache latency for memory read	62	Peripheral AXI interface data read latency
59	Data cache latency for memory write	63	Peripheral AXI interface data write latency
60	Instruction cache latency for memory read		

The debug registers used to configure and control performance monitoring, and to read or write the event and latency counters, are listed in the following table. All of these registers except the Performance Counter Command register are accessed repeatedly to read or write information, first for all of the event counters followed by all of the latency counters.

The `DBG_CTRL` value indicates the value to use in the MDM Debug Register Access Control Register to access the register, used with MDM software access to debug registers.

Table 43: MicroBlaze Performance Monitoring Debug Registers

Register Name	Size (bits)	MDM Command	DBG_CTRL Value	R/W	Description
Performance Counter Control	8	0101 0001	4A207	W	Select event for each configured counter, according to the previous table
Performance Counter Command	5	0101 0010	4A404	W	Command to clear counters, start or stop counting, or sample counters
Performance Counter Status	2	0101 0011	4A601	R	Read the sampled status for each configured performance counter
Performance Counter Data Read	32	0101 0110	4AC1F	R	Read the sampled values for each configured performance counter
Performance Counter Data Write	32	0101 0111	4AE1F	W	Write initial values for each configured performance counter

Performance Counter Control Register

The Performance Counter Control Register (PCCTRLR) is used to define the events that are counted by the configured performance counters. To define the events for all configured counters, the register should be written repeatedly for each of the counters. This register is a write-only register. Issuing a read request has no effect, and undefined data is read.

Every time the register is written, the selected counter is incremented. By using the Performance Counter Command Register, the selected counter can be reset to the first counter again. See the following figure and table.

Figure 30: Performance Counter Control Register

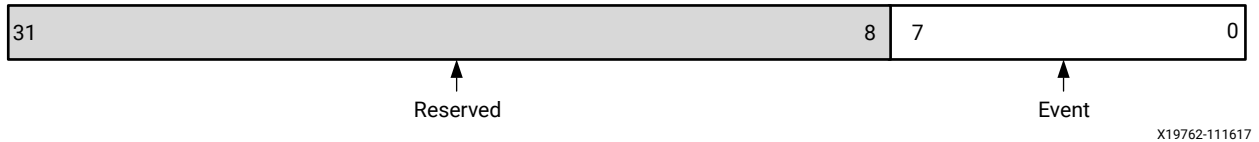

Table 44: Performance Counter Control Register

Bits	Name	Description	Reset Value
7:0	Event	Performance counter event, according to Table 42: MicroBlaze Performance Monitoring Events .	0

Performance Counter Command Register

The Performance Counter Command Register (PCCMDR) is used to issue commands to clear, start, stop, or sample all counters. This register is a write-only register. Issuing a read request has no effect, and undefined data is read.

Figure 31: Performance Counter Command Register

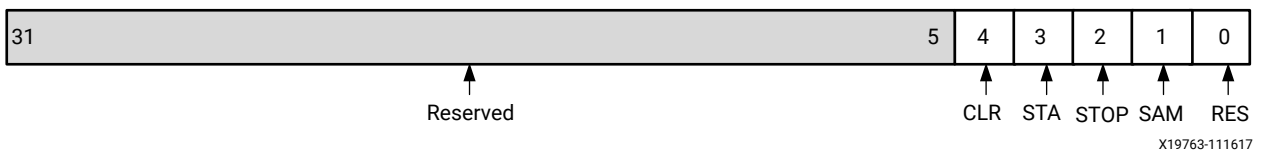

Table 45: Performance Counter Command Register

Bits	Name	Description	Reset Value
4	Clear	Clear all counters to zero	0
3	Start	Start counting configured events for all counters simultaneously	0
2	Stop	Stop counting all counters simultaneously	0
1	Sample	Sample status and values in all counters simultaneously for reading	0
0	Reset	Reset accessed counter to the first event counter for access using the Performance Counter Control, Status, Read Data and Write Data	0

Performance Counter Status Register

The Performance Counter Status Register (PCSR) reads the sampled status of the counters. To read the status for all configured counters, the register should be read repeatedly for each of the counters. This register is a read-only register. Issuing a write request to the register does nothing.

Every time the register is read, the selected counter is incremented. By using the Performance Counter Command Register, the selected counter can be reset to the first counter again. See the following figure and table.

Figure 32: Performance Counter Status Register

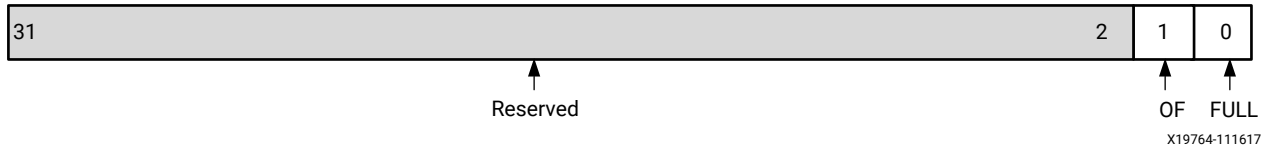

Table 46: Performance Counter Status Register

Bits	Name	Description	Reset Value
1	Overflow	This bit is set when the counter has counted past its maximum value	0
0	Full	This bit is set when a new latency counter event is started before the previous event has finished. This indicates that the accuracy of the measured values is reduced.	0

Performance Counter Data Read Register

The Performance Counter Data Read Register (PCDRR) reads the sampled values of the counters. To read the values of all configured counters, the register should be read repeatedly. This register is a read-only register. Issuing a write request to the register does nothing.

See the following figure and table.

Figure 33: Performance Counter Data Read Register

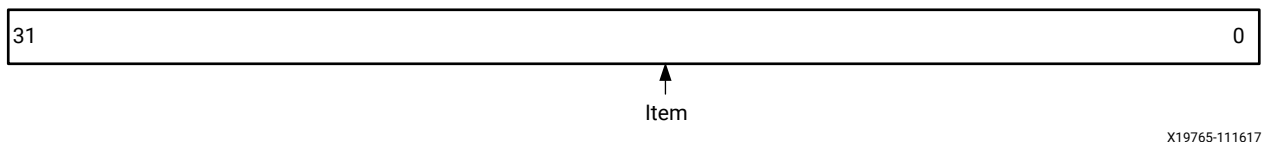

Table 47: Performance Counter Data Read Register

Bits	Name	Description	Reset Value
31:0	Item	Sampled counter value item	0

Because a counter can have more than 32 bits, depending on the configuration, the register might need to be read repeatedly to retrieve all information for a particular counter. This is detailed in the following table.

Table 48: Performance Counter Data Items

Counter Type	Item	Description	
C_DEBUG_COUNTER_WIDTH = 32			
Event Counter	1	The number of times the event occurred	
Latency Counter	1	The number of times the event occurred	
	2	The sum of each event latency	
	3	The sum of each event latency squared	
	4	31:16 15:0	Minimum measured latency, 16 bits Maximum measured latency, 16 bits
C_DEBUG_COUNTER_WIDTH = 48			
Event Counter	1	31:1615:0	0x0000 The number of times the event occurred, 16 most significant bits
	2	The number of times the event occurred, 32 least significant bits	
Latency Counter	1	The number of times the event occurred	
	2	31:16 15:0	0x0000 The sum of each event latency, 16 most significant bits
	3	The sum of each event latency, 32 least significant bits	
	4	31:16 15:0	0x0000 The sum of each event latency squared, 16 most significant bits
	5	The sum of each event latency squared, 32 least significant bits	
	6	Minimum measured latency, 32 bits	
	7	Maximum measured latency, 32 bits	
C_DEBUG_COUNTER_WIDTH = 64			
Event Counter	1	The number of times the event occurred, 32 most significant bits	
	2	The number of times the event occurred, 32 least significant bits	
Latency Counter	1	The number of times the event occurred, 32 bits	
	2	The sum of each event latency, 32 most significant bits	
	3	The sum of each event latency, 32 least significant bits	
	4	The sum of each event latency squared, 32 most significant bits	
	5	The sum of each event latency squared, 32 least significant bits	
	6	Minimum measured latency, 32 bits	
	7	Maximum measured latency, 32 bits	

Performance Counter Data Write Register

The Performance Counter Data Write Register (PCDWR) writes initial values to the counters. To write all configured counters, the register should be written repeatedly. This register is a write-only register. Issuing a read request has no effect, and undefined data is read.

Because a counter can have more than 32 bits, depending on the configuration, the register might need to be written repeatedly to update all information for a particular counter, as described in [Table 48: Performance Counter Data Items](#).

Figure 34: Performance Counter Data Write Register

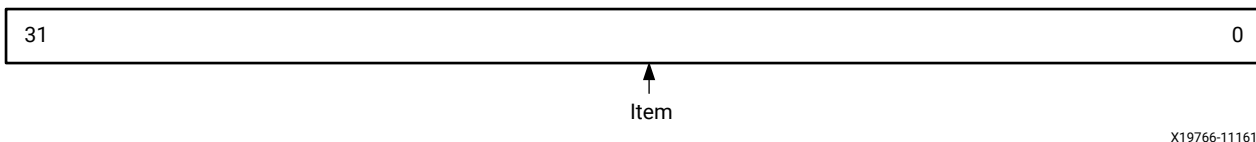

X19766-111617

Table 49: Performance Counter Data Write Register (PCDWR)

Bits	Name	Description	Reset Value
31:0	Item	Counter value item to write into a counter	0

Program and Event Trace

With extended debugging, MicroBlaze provides program and event trace, either storing information in the Embedded Trace Buffer or transmitting it to the MDM, to enable program execution tracing. The MDM is used when the parameter `C_DEBUG_EXTERNAL_TRACE` is set, allowing output of program trace from multiple processors using external interfaces.

The size of the Embedded Trace Buffer can be configured from 8 KB to 128 KB using the parameter `C_DEBUG_TRACE_SIZE`. The default buffer size with external trace is 8 KB, but it can also be configured from 32B to 256B to use distributed RAM. It is recommended to always keep the default 8 KB size, unless block RAM resources are very scarce. By setting `C_DEBUG_TRACE_SIZE` to 0 (None), program trace is disabled.

Program trace uses compression to reduce the amount of trace data, while still allowing reconstruction of the program execution flow or the entire processor software state. There are three main compression levels:

- **Complete trace:** Stores complete trace information including cycle count for each executed instruction using 144 bits, ranging from 512 to 8192 items depending on the configured Embedded Trace Buffer size. Complete trace is not available when `C_DEBUG_EXTERNAL_TRACE` is set or with 64-bit MicroBlaze (`C_DATA_SIZE = 64`).
- **Program flow:** Stores program flow changes, that is the sequence of branches taken or not taken, and the new program counter for indirect branches, interrupts, exceptions, and hardware breaks.

The program counter can also optionally be stored for return instructions to simplify program flow reconstruction, or for all taken branches to handle self-modifying code.

Data read from memory or fetched from AXI4-Stream interfaces might optionally be stored to allow reconstructing the entire processor software state, enabling reverse single step functionality. When the data access instruction is in a delay slot of a dynamic branch or return, the data is stored first followed by the branch target program counter. For data access instructions in delay slots of static branches, the program flow change is first saved followed by the data.

Events representing all program exceptions, interrupts, and breaks, as well as all cross-trigger events defined in [Table 63: MicroBlaze Cross Trigger Actions](#) are also stored, to allow unambiguous decoding of program flow changes. Each event is preceded by a stored program counter.

Software can inject an event by using an “xori r0, rN, IMM” instruction. Typically this is used to trace operating system events like context switches and system calls, but it can be used by any program to trace significant events.

- **Program flow and cycle count:** Stores the cycle count between instructions along with the same information as program flow alone, to also allow reconstruction of the program execution time.
- **Event Trace:** Stores event trace information including cycle count events. Events include all program exceptions, interrupts, and breaks, as well as all cross-trigger events defined in [Table 63: MicroBlaze Cross Trigger Actions](#). Each event is optionally preceded by a stored program counter.

The program counter can also optionally be stored for call instructions to trace function calls in the program, and for return instructions to trace function call returns.

Software can inject an event by using an “xori r0, rA, IMM” instruction. Typically this is used to trace operating system events like context switches and system calls, but it can be used by any program to trace significant events.

Tracing can be started using the Trace Command Register, by hitting a program breakpoint or watchpoint configured as a tracepoint in the Trace Control Register, or by a cross trigger event (see [Table 63: MicroBlaze Cross Trigger Actions](#)).

Tracing is automatically stopped when the trace buffer becomes full, and can be stopped using the Trace Command Register or by a cross trigger event (see [Table 63: MicroBlaze Cross Trigger Actions](#)).

The cycle count can measure up to 32768 clock cycles when using complete trace, and up to 8192 cycles between instructions when using program flow and cycle count. If the cycle count exceeds this value, the Trace Status Register overflow bit is set to one.

It is possible to configure trace to halt the processor when the trace buffer becomes full or when the cycle count overflows. This allows continuous trace of the entire program flow, albeit not in real time due to the time required to read the trace buffer.

The debug registers used to configure and control tracing, and to read the Embedded Trace Buffer, are listed in the following table.

The `DBG_CTRL` value indicates the value to use in the MDM Debug Register Access Control Register to access the register, used with MDM software access to debug registers.

Table 50: MicroBlaze Program Trace Debug Registers

Register Name	Size (bits)	MDM Command	DBG_CTRL Value	R/W	Description
Trace Control	22	0110 0001	4C215	W	Set tracepoints, trace compression level and optionally stored trace information
Trace Command	4	0110 0010	4C403	W	Command to clear trace buffer, start or stop trace, and sample number of current buffer items
Trace Status	18	0110 0011	4C611	R	Read the sampled trace buffer status
Trace Data Read ¹	18	0110 0110	4CC11	R	Read the oldest item from the Embedded Trace Buffer

Notes:

1. This register is not available when C_DEBUG_EXTERNAL_TRACE is set.

Trace Control Register

The Trace Control Register (TCTRLR) is used to define the trace behavior. This register is a write-only register. Issuing a read request has no effect, and undefined data is read. See the following figure and table.

Figure 35: Trace Control Register

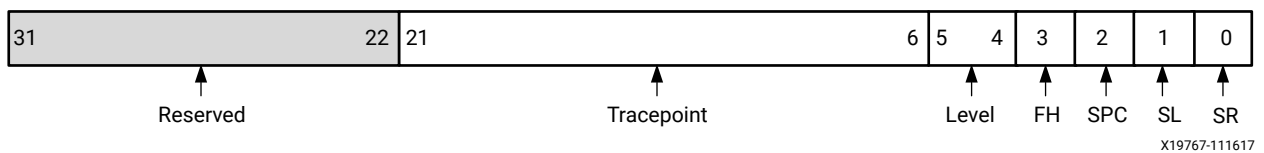

Table 51: Trace Control Register (TCTRLR)

Bits	Name	Description	Reset Value
21:6	Tracepoint	Change corresponding breakpoint or watchpoint to a tracepoint	0
5:4	Level	Trace compression level: 00 = Complete trace, not available with C_DEBUG_EXTERNAL_TRACE 01 = Program flow 10 = Event 11 = Program flow and cycle count	00
3	Full Halt	Debug Halt on full trace buffer or cycle count overflow	0
2	Save PC	Level 01 and 11: Save new program counter for all taken branches Level 10: Save new program counter for all function calls	0
1	Save Load	Save load and get instruction new data value	0
0	Save Return	Save new program counter for return instructions	0

Trace Command Register

The Trace Command Register (TCMDR) is used to issue commands to clear, start, or stop trace, as well as sample the number of trace items. This register is a write-only register. Issuing a read request has no effect, and undefined data is read. See the following figure and table.

Figure 36: Trace Command Register

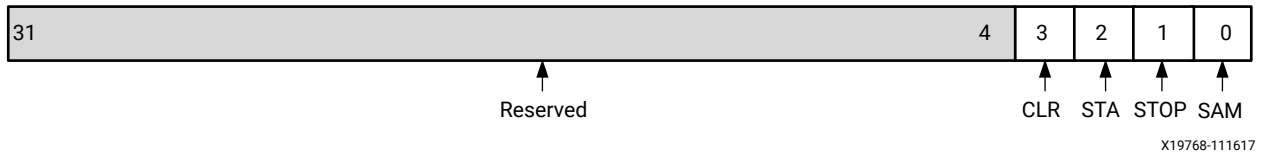

X19768-111617

Table 52: Trace Command Register

Bits	Name	Description	Reset Value
3	Clear	Clear trace status and empty the trace buffer	0
2	Start	Start trace immediately	0
1	Stop	Stop trace immediately	0
0	Sample	Sample the number of current items in the trace buffer	0

Trace Status Register

The Trace Status Register (TSR) can be used to determine if trace has been started or not, to check for cycle count overflow and to read the sampled number of items in the Embedded Trace Buffer. This register is a read-only register. Issuing a write request to the register does nothing. See the following figure and table.

Figure 37: Trace Status Register

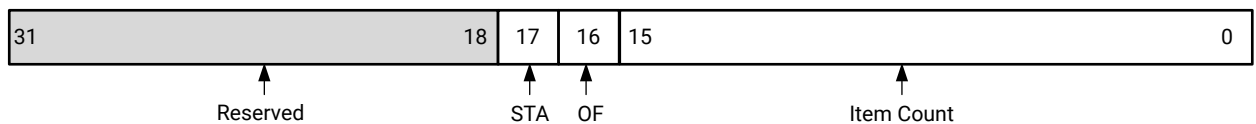

X19769-111617

Table 53: Trace Status Register

Bits	Name	Description	Reset Value
17	Started	Trace started, set to one when trace is started and cleared to zero when it is stopped	0
16	Overflow	Cycle count overflow, set to one when the cycle count overflows, and cleared to zero by the Clear command	0
15:0	Item Count	Sampled trace buffer item count	0x0000

Trace Data Read Register

The Trace Data Read Register (TDRR) contains the oldest item read from the Embedded Trace Buffer. When the register has been read, the next item is read from the trace buffer. It is an error to read more items than are available in the trace buffer, as indicated by the item count in the Trace Status Register. This register is a read-only register. Issuing a write request to the register does nothing. See the following figure and table.

Figure 38: Trace Data Read Register

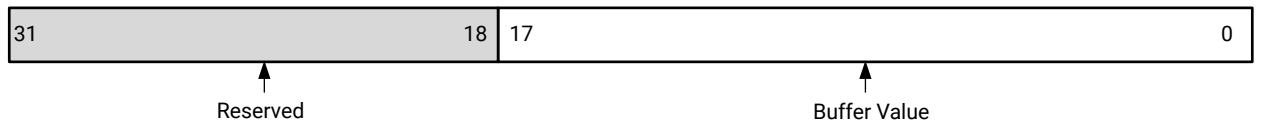

X19770-111617

Because a trace data entity can consist of more than 18 bits, depending on the compression level and stored data, the register might need to be read repeatedly to retrieve all information for a particular data entity. This is detailed in [Table 55: Trace Counter Data Entities](#).

Table 54: Trace Data Read Register

Bits	Name	Description	Reset Value
17:0	Buffer Value	Embedded Trace Buffer item	0x00000

Table 55: Trace Counter Data Entities

Entity	Item	Bits	Description
Complete Trace	1	17:3 2:0	Cycle count for the executed instruction Machine Status Register [17:19]
	2	17:6 5:1 0	Machine Status Register [20:31] Destination register address (r0 - r31), valid if written Destination register written if set to one
	3	17:13 12 11 10 9:6 5:0	Exception Status Register , valid if exception taken Exception taken if set to one Load instruction reading data if set to one Store instruction writing data if set to one Byte enable, valid for store instruction Write data [0:5] for store instructions, or Destination register data [0:5] for other instructions
	4	17:0	Write data [6:23] or Destination register data [6:23]
	5	17:10 9:0	Write data [24:31] or Destination register data [24:31] Data address [0:9] for load and store instructions, or Executed instruction [0:9] for other instruction

Table 55: Trace Counter Data Entities (cont'd)

Entity	Item	Bits	Description
	6	17:0	Data address [10:27] or Executed instruction [10:27]
	7	17:14 13:0	Data address [28:31] or Executed instruction [28:31] Program Counter [0:13]
	8	17:0	Program Counter [14:31]
Program Flow: Branches	1	17:16 15:12 11:0	00 - The item contains program flow branches Number of branches (N) counted in the item (0 - 12) The N leftmost bits represent branches in the program flow. If the bit is set to one the branch is taken, otherwise it is not taken. An item with 0 branches can be ignored, and can occur when flushing external trace, in order to complete a trace packet.
Program Flow: Program Counter	1	17:16 15:0	01 - The item contains a Program Counter value Program Counter [0:15]
	2	17:16 15:0	01 - The item contains a Program Counter value Program Counter [16:31]
Program Flow: Program Counter C_ADDR_SIZE = 32 - 48	1	17:16 15:0	01 - The item contains a Program Counter value Program Counter [0:C_ADDR_SIZE-33] zero extended
	2	17:16 15:0	01 - The item contains a Program Counter value Program Counter [C_ADDR_SIZE-32:C_ADDR_SIZE-17]
	3	17:16 15:0	01 - The item contains a Program Counter value Program Counter [C_ADDR_SIZE-16:C_ADDR_SIZE-1]
Program Flow: Program Counter C_ADDR_SIZE = 49 - 64	1	17:16 15:0	01 - The item contains a Program Counter value Program Counter [0:C_ADDR_SIZE-49] zero extended
	2	17:16 15:0	01 - The item contains a Program Counter value Program Counter [C_ADDR_SIZE-48:C_ADDR_SIZE-33]
	3	17:16 15:0	01 - The item contains a Program Counter value Program Counter [C_ADDR_SIZE-32:C_ADDR_SIZE-17]
	4	17:16 15:0	01 - The item contains a Program Counter value Program Counter [C_ADDR_SIZE-16:C_ADDR_SIZE-1]
Program Flow: Read Data C_DATA_SIZE = 32 or 64	1	17:16 15:0	10 - The item contains read data Data read by load and get instructions [0:15]
	2	17:16 15:0	10 - The item contains read data Data read by load and get instructions [15:31]
Program Flow: Read Data C_DATA_SIZE = 64	1	17:16 15:0	10 - The item contains read data Data read by long load instructions [0:15]
	2	17:16 15:0	10 - The item contains read data Data read by long load instructions [15:31]

Table 55: Trace Counter Data Entities (cont'd)

Entity	Item	Bits	Description
	3	17:16 15:0	10 - The item contains read data Data read by long load instructions [32:47]
	4	17:16 15:0	10 - The item contains read data Data read by long load instructions [48:63]
Program Flow, Event: Event Instruction event	1	17:16 15:14 13:0	11 - The item contains an event 00 - Instruction event Software generated trace event: result of instruction "xori r0, rA, IMM."
Program Flow, Event: Event Cross-trigger event	1	17:16 15:1 13:8 7:0	11 - The item contains an event 10 - Cross-trigger event Reserved Events according to "MicroBlaze Cross Trigger Events" defined in Table 64: MicroBlaze Cross Trigger Events . Each event is represented by setting the corresponding bit in the bit field.
Program Flow, Event: Event Exception event	1	17:1615:1413:5 4:0	11 - The item contains an event 11 - Exception event: Reserved Exception cause, according to "ESR Exception Cause", defined in LNK TBD, and: 01001 - Debug exception: Breakpoint, Stop 01010 - Interrupt 01011 - Non-maskable break 01100 - Break
Event: Event Time Stamp	1	17:16 15:14 13:0	11 - The item contains an event 01 - Time stamp Cycle count since last time stamp
Program Flow with Cycle Count: Branches and short cycle count	1	17:16 15:14 13:8 7 6:1 0	00 - The item contains program flow branches 01, 10 - Number of branches (N) counted (1 - 2) Cycle count for previously executed instructions Branch is taken if set to one, otherwise it is not taken Cycle count for previously executed instructions Branch is taken if set to one, otherwise it is not taken
Program Flow with Cycle Count: Branch and long cycle count	1	17:16 15:14 13:1 0	00 - The item contains program flow branches 11 - The item contains branch and long cycle count Cycle count for previously executed instructions Branch is taken if set to one, otherwise it is not taken

Non-Intrusive Profiling

With extended debugging, non-intrusive profiling is provided, which uses a Profiling Buffer to store program execution statistics. The size of the profiling buffer can be configured from 4 KB to 128 KB using the parameter `C_DEBUG_PROFILE_SIZE`. By setting `C_DEBUG_PROFILE_SIZE` to 0 (None), non-intrusive profiling is disabled.

The Profiling Buffer is divided into a number of bins, each counting the number of executed instructions or clock cycles within a certain address range. Each bin counts up to $2^{36} - 1 = 68719476735$ instructions or cycles.

The address range of each bin is determined by the buffer size and the profiled address range defined using the Profiling Low Address Register and Profiling High Address Register.

Profiling can be started or stopped using the Profiling Control Register or by cross trigger events (see [Cross Trigger Support](#)).

The debug registers used to configure and control profiling, and to read or write the Profiling Buffer, are listed in the following table.

The `DBG_CTRL` value indicates the value to use in the MDM Debug Register Access Control Register to access the register, used with MDM software access to debug registers.

Table 56: MicroBlaze Profiling Debug Registers

Register Name	Size (bits)	MDM Command	DBG_CTRL Value	R/W	Description
Profiling Control	8	0111 0001	4E207	W	Enable or disable profiling, configure counting method and bin usage
Profiling Low Address	<code>C_ADDR_SIZE - 2</code>	0111 0010	4E41D	W	Defines the low address of the profiled address range
Profiling High Address	<code>C_ADDR_SIZE - 2</code>	0111 0011	4E61D	W	Defines the high address of the profiled address range
Profiling Buffer Address	9 - 14	0111 0100	9: 4E808 10: 4E809 ... 14: 4E80D	W	Sets the address (bin) in the Profiling Buffer to read or write
Profiling Data Read	36	0111 0110	4EC23	R	Read data from the Profiling Buffer
Profiling Data Write	32	0111 0111	4EE1F	W	Write data to the Profiling Buffer

Profiling Control Register

The Profiling Control Register (PCTRLR) is used to enable (start) profiling and disable (stop) profiling. It is also used to configure whether to count the number of executed instructions or the number of executed clock cycles, as well as define the Profiling Buffer bin usage.

This register is a write-only register. Issuing a read request has no effect, and undefined data is read. See the following figure and table.

The Bin Control value (B) can be calculated by the following formula:

Equation 3: Bin Control Value (B)

$$B = \left\lceil \log_2 \frac{H-L+S \cdot 4}{S \cdot 4} \right\rceil$$

where:

- L is the Profiling Low Register
- H is the Profiling High Register
- S is the parameter C_DEBUG_PROFILE_SIZE.

Figure 39: Profiling Control Register

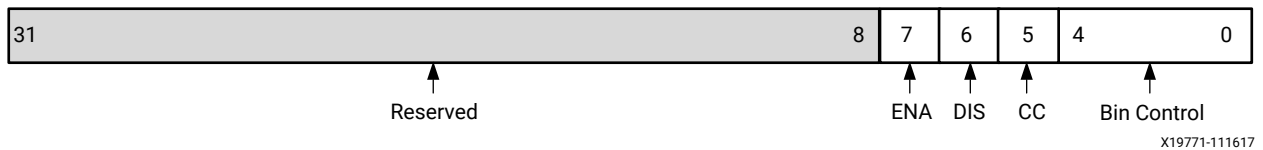

Table 57: Profiling Control Register

Bits	Name	Description	Reset Value
7	Enable	Enable and start profiling	0
6	Disable	Disable and stop profiling	0
5	Enable Cycle Count	Enable cycle count to count clock cycles of executed instruction: 0 = Disabled, number of executed instructions counted 1 = Enabled, clock cycles of executed instructions counted	0
4:0	Bin Control	The number of addresses counted by each bin in the Profiling Buffer	00000

Profiling Low Address Register

The Profiling Low Address Register (PLAR) is used to define the low word address of the profiled area. This register is a write-only register. Issuing a read request has no effect, and undefined data is read. See the following figure and table.

Figure 40: Profiling Low Address Register

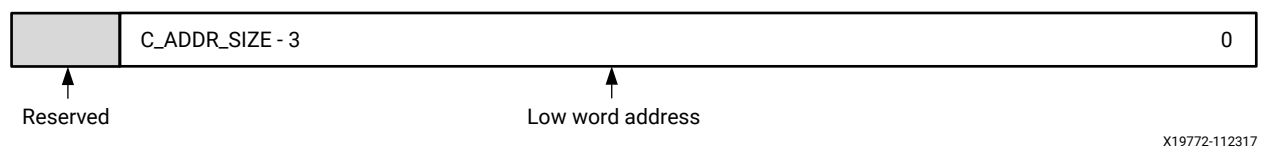

Table 58: Profiling Low Address Register

Bits	Name	Description	Reset Value
C_ADDR_SIZE-3:0	Low word	Low word address of the profiled area	0

Profiling High Address Register

The Profiling High Address Register (PHAR) is used to define the high word address of the profiled area. This register is a write-only register. Issuing a read request has no effect, and undefined data is read. See the following figure and table.

Figure 41: Profiling High Address Register

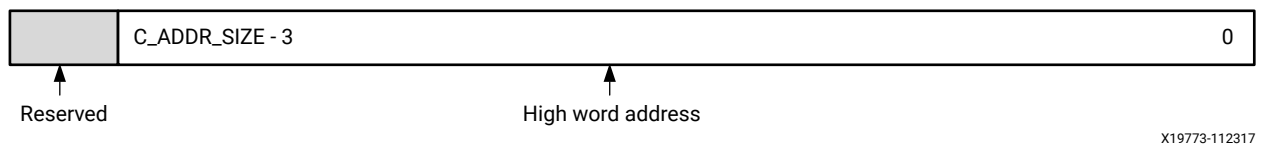

X19773-112317

Table 59: Profiling High Address Register

Bits	Name	Description	Reset Value
C_ADDR_SIZE-3:0	High word	High word address of the profiled area	0

Profiling Buffer Address Register

The Profiling Buffer Address Register (PBAR) is used to define the bin in the Profiling Buffer to be read or written. This register has variable number of bits, depending on the parameter C_DEBUG_PROFILE_SIZE.

This register is a write-only register. Issuing a read request has no effect, and undefined data is read. See the following figure and table.

Figure 42: Profiling Buffer Address Register

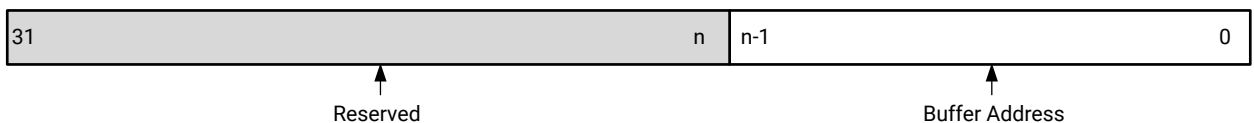

X19774-111617

Table 60: Profiling Buffer Address Register

Bits	Name	Description	Reset Value
n-1:0	Buffer Address	Bin in the Profiling Buffer to read or write. The number of bits (n) is 10 for a 4 KB buffer, 11 for a 8 KB buffer, ..., 15 for a 128 KB buffer.	0

Profiling Data Read Register

The Profiling Data Read Register (PDRR) reads the bin value indicated by the Profiling Buffer Address Register and increments the Profiling Buffer Address Register. This register is a read-only register. Issuing a write request to the register does nothing. See the following figure and table.

When reading this register with MDM software access to debug registers, data is read with two consecutive accesses.

Figure 43: Profiling Data Read Register

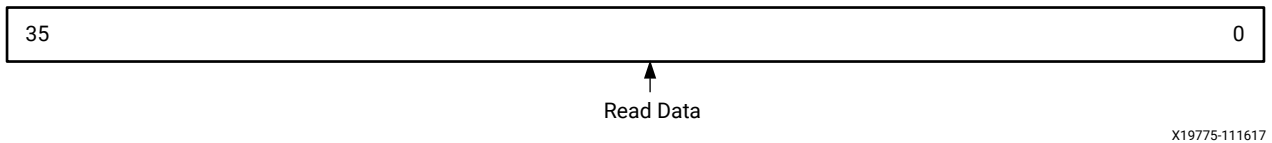

Table 61: Profiling Data Read Register

Bits	Name	Description	Reset Value
35:0	Read Data	Number of executed instructions or executed clock cycles in the bin	0

Profiling Data Write Register

The Profiling Data Write Register (PDWR) writes a new value to the bin indicated by the Profiling Buffer Address Register and increments the Profiling Buffer Address Register. This register is a write-only register. Issuing a read request has no effect, and undefined data is read.

This register can be used to clear the Profiling Buffer before enabling profiling.

The four most significant bits in the Profiling Buffer bin are set to zero when writing the new value. See the following figure and table.

Figure 44: Profiling Data Write Register

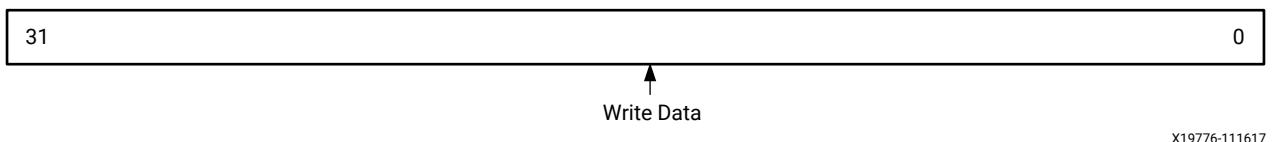

Table 62: Profiling Data Write Register

Bits	Name	Description	Reset Value
31:0	Write Data	Data to write to a bin.	0

Cross Trigger Support

With basic debugging, cross trigger support is provided by two signals, `DBG_STOP` and `MB_Halted`.

- When the `DBG_STOP` input is set to 1, MicroBlaze will halt after a few instructions. XSDB will detect that MicroBlaze has halted, and indicate where the halt occurred. The signal can be used to halt MicroBlaze at any external event, for example when a Vivado Integrated Logic Analyzer (ILA) is triggered.
- Whenever MicroBlaze is halted, the `MB_Halted` output signal is set to 1; for example after a breakpoint or watchpoint is hit, after a stop XSDB command, or when the `DBG_STOP` input is set. The output is cleared when MicroBlaze execution is resumed by an XSDB command.

The `MB_Halted` signal can be used to trigger a Vivado integrated logic analyzer, or halt other MicroBlaze cores in a multiprocessor system by connecting the signal to their `DBG_STOP` inputs.

With extended debugging, cross trigger support is available with the MDM. The MDM provides programmable cross triggering between all connected processors, as well as external trigger inputs and outputs. For details, see the *MicroBlaze Debug Module (MDM) LogiCORE IP Product Guide* (PG115).

MicroBlaze can handle up to eight cross trigger actions. Cross trigger actions are generated by the corresponding MDM cross trigger outputs, connected using the Debug bus. The effect of each of the cross trigger actions is listed in the following table.

MicroBlaze can generate up to eight cross trigger events. Cross trigger events affect the corresponding MDM cross trigger inputs, connected using the Debug bus. The cross trigger events are described in [Table 64: MicroBlaze Cross Trigger Events](#).

Table 63: MicroBlaze Cross Trigger Actions

Number	Action	Description
0	Debug stop	Stop MicroBlaze if the processor is executing, and set the <code>MB_Halted</code> output. The same effect is achieved by setting the <code>Dbg_Stop</code> input.
1	Continue execution	Continue execution if the processor is stopped, and clear the <code>MB_Halted</code> output.
2	Stop program trace	Stop program trace if tracing is in progress.
3	Start program trace	Start program trace if trace is stopped.
4	Stop performance monitoring	Stop performance monitoring if it is in progress.
5	Start performance monitoring	Start performance monitoring if it is stopped.
6	Disable profiling	Disable profiling if it is in progress.
7	Enable profiling	Enable profiling if it is disabled.

Table 64: MicroBlaze Cross Trigger Events

Number	Event	Description
0	MicroBlaze halted	Generate an event when MicroBlaze is halted. The same event is signaled when the <code>MB_Halted</code> output is set.
1	Execution resumed	Generate an event when the processor resumes execution from debug halt. The same event is signaled when the <code>MB_Halted</code> output is cleared.
2	Program trace stopped	Generate an event when program trace is stopped by writing a command to the Program Trace Command Register, when the trace buffer is full, or by a cross trigger action.
3	Program trace started	Generate an event when program trace is started by writing a command to the Program Trace Command Register, by hitting a tracepoint, or by a cross trigger action.
4	Performance monitoring stopped	Generate an event when performance monitoring is stopped by writing a command to the Performance Counter Command Register or by a cross trigger action.
5	Performance monitoring started	Generate an event when performance monitoring is started by writing a command to the Performance Counter Command Register, or by a cross trigger action.
6	Profiling disabled	Generate an event when profiling is enabled by writing a command to the Profiling Control Register or by a cross trigger action.
7	Profiling enabled	Generate an event when profiling is disabled by writing a command to the Profiling Control Register or by a cross trigger action.

Trace Interface Overview

The MicroBlaze trace interface exports a number of internal state signals for performance monitoring and analysis.



RECOMMENDED: AMD recommends that users only use the trace interface through AMD developed analysis cores.

This interface is not guaranteed to be backward compatible in future releases of MicroBlaze. See [Table 87: Mapping of Trace MSR](#) for a list of exported signals.

Fault Tolerance

The fault tolerance features included in MicroBlaze, enabled with `C_FAULT_TOLERANT`, provide Error Detection for internal block RAMs (in the Instruction Cache, Data Cache, Branch Target Cache, and MMU), and support for Error Detection and Correction (ECC) in LMB block RAMs. When fault tolerance is enabled, all soft errors in block RAMs are detected and corrected, which significantly reduces overall failure intensity.

In addition to protecting block RAM, the FPGA configuration memory also generally needs to be protected. A detailed explanation of this topic, and further references, can be found in the two documents *Soft Error Mitigation Controller LogiCORE IP Product Guide (PG036)* and *UltraScale Architecture Soft Error Mitigation Controller LogiCORE IP Product Guide (PG187)*.

To further increase fault tolerance, a complete triple modular redundancy (TMR) solution is provided for MicroBlaze, using additional cores to handle majority voting and fault detection. See the *Triple Modular Redundancy (TMR) LogiCORE IP Product Guide (PG268)* for a complete description and implementation details.

Configuration

Using MicroBlaze Configuration

You can enable Fault tolerance on the General page of the MicroBlaze configuration dialog box.

After enabling fault tolerance in MicroBlaze, ECC is automatically enabled in the connected LMB BRAM Interface Controllers by the tools, when the system is generated. This means that nothing else needs to be configured to enable fault tolerance and minimal ECC support.

It is possible (albeit not recommended) to manually override ECC support, leaving the LMB BRAM unprotected, by disabling C_ECC in the configuration dialogs of all connected LMB BRAM Interface Controllers.

In this case, the internal MicroBlaze block RAM protection is still enabled, because fault tolerance is enabled.

Using LMB BRAM Interface Controller Configuration

As an alternative to the method described above, it is also possible to enable ECC in the configuration dialogs of all connected LMB BRAM Interface Controllers.

In this case, fault tolerance is automatically enabled in MicroBlaze by the tools, when the system is generated. This means that nothing else needs to be configured to enable ECC support and MicroBlaze fault tolerance.

ECC must either be enabled or disabled in all Controllers, which is enforced by a DRC.

It is possible to manually override fault tolerance support in MicroBlaze, by explicitly disabling C_FAULT_TOLERANT in the MicroBlaze configuration dialog. This is not recommended, unless no block RAM is used in MicroBlaze, and there is no need to handle bus exceptions from uncorrectable ECC errors.

Features

An overview of all MicroBlaze fault tolerance features is given here. Further details on each feature can be found in the following sections:

- [Instruction Cache](#)
- [Data Cache](#)
- [UTLB Management](#)
- [Branch Target Cache](#)
- [Exception Causes](#)

The LMB BRAM Interface Controller v4.0 or later provides the LMB ECC implementation. For details, including performance and resource utilization, see the *LMB BRAM Interface Controller LogiCORE IP Product Guide* ([PG112](#)).

Instruction and Data Cache Protection

To protect the block RAM in the Instruction and Data Cache, parity is used. When a parity error is detected, the corresponding cache line is invalidated. This forces the cache to reload the correct value from external memory. Parity is checked whenever a cache hit occurs.

Note: This scheme only works for write-through, and thus write-back data cache is not available when fault tolerance is enabled. This is enforced by a DRC.

When new values are written to a block RAM in the cache, parity is also calculated and written. One parity bit is used for the tag, one parity bit for the instruction cache data, and one parity bit for each byte in a data cache line.

In many cases, enabling fault tolerance does not increase the required number of cache block RAMs, because spare bits can be used for the parity. Any increase in resource utilization, in particular number of block RAMs, can easily be seen in the MicroBlaze configuration dialog, when enabling fault tolerance.

Memory Management Unit Protection

To protect the block RAM in the MMU Unified Translation Look-Aside Buffer (UTLB), parity is used. When a parity error is detected during an address translation, a TLB miss exception occurs, forcing software to reload the entry.

When a new TLB entry is written using the TLBHI and TLBLO registers, parity is calculated. One parity bit is used for each entry.

Parity is also checked when a UTLB entry is read using the TLBHI and TLBLO registers. When a parity error is detected in this case, the entry is marked invalid by clearing the valid bit.

Enabling fault tolerance does not increase the MMU block RAM size, because a spare bit is available for the parity.

Branch Target Cache Protection

To protect block RAM in the Branch Target Cache, parity is used. When a parity error is detected when looking up a branch target address, the address is ignored, forcing a normal branch.

When a new branch address is written to the Branch Target Cache, parity is calculated. One parity bit is used for each address.

Enabling fault tolerance does not increase the Branch Target Cache block RAM size, because a spare bit is available for the parity.

Exception Handling

With fault tolerance enabled, if an error occurs in LMB block RAM, the LMB BRAM Interface Controller generates error signals on the LMB interface.

If exceptions are enabled in the MicroBlaze processor by setting the EE bit in the Machine Status Register, the uncorrectable error signal either generates an instruction bus exception or a data bus exception, depending on the affected interface.

Should a bus exception occur when an exception is in progress, MicroBlaze is halted, and the external error signal `MB_Error` is set. This behavior ensures that it is impossible to execute an instruction corrupted by an uncorrectable error.

Software Support

Scrubbing

To ensure that bit errors are not accumulated in block RAMs, they must be periodically scrubbed.

The standalone BSP provides the function `microblaze_scrub()` to perform scrubbing of the entire LMB block RAM and all MicroBlaze internal block RAMs used in a particular configuration. This function is intended to be called periodically from a timer interrupt routine. One location of each block RAM is scrubbed every time it is called, using persistent data to track the current locations.

The following example code illustrates how this can be done.

```
#include "xparameters.h"
#include "xtmrctr.h"
#include "xintc.h"
#include "mb_interface.h"

#define SCRUB_PERIOD ...
```

```

XIntc InterruptController; /* The Interrupt Controller instance */
XTmrCtr TimerCounterInst; /* The Timer Counter instance */

void MicroBlazeScrubHandler(void *CallBackRef, u8 TmrCtrNumber)
{
    /* Perform other timer interrupt processing here */
    microblaze_scrub();
}

int main (void)
{
    int Status;
    /*
     * Initialize the timer counter so that it's ready to use,
     * specify the device ID that is generated in xparameters.h
     */
    Status = XTmrCtr_Initialize(&TimerCounterInst, TMRCTR_DEVICE_ID);
    if (Status != XST_SUCCESS) {
        return XST_FAILURE;
    }

    /*
     * Connect the timer counter to the interrupt subsystem such that
     * interrupts can occur.
     */
    Status = XIntc_Initialize(&InterruptController, INTC_DEVICE_ID);
    if (Status != XST_SUCCESS) {
        return XST_FAILURE;
    }

    /*
     * Connect a device driver handler that will be called when an
     * interrupt for the device occurs, the device driver handler performs
     * the specific interrupt processing for the device
     */
    Status = XIntc_Connect(&InterruptController, TMRCTR_DEVICE_ID,
        (XInterruptHandler)XTmrCtr_InterruptHandler,
        (void *) &TimerCounterInst);
    if (Status != XST_SUCCESS) {
        return XST_FAILURE;
    }

    /*
     * Start the interrupt controller such that interrupts are enabled for
     * all devices that cause interrupts, specifying real mode so that the
     * timer counter can cause interrupts thru the interrupt controller.
     */
    Status = XIntc_Start(&InterruptController, XIN_REAL_MODE);
    if (Status != XST_SUCCESS) {
        return XST_FAILURE;
    }

    /*
     * Setup the handler for the timer counter that will be called from the
     * interrupt context when the timer expires, specify a pointer to the
     * timer counter driver instance as the callback reference so the
     * handler is able to access the instance data
     */
    XTmrCtr_SetHandler(&TimerCounterInst, MicroBlazeScrubHandler,
        &TimerCounterInst);

    /*
     * Enable the interrupt of the timer counter so interrupts will occur

```

```

    * and use auto reload mode such that the timer counter will reload
    * itself automatically and continue repeatedly, without this option
    * it would expire once only
    */
    XTmrCtr_SetOptions(&TimerCounterInst, TIMER_CNTR_0,
        XTC_INT_MODE_OPTION | XTC_AUTO_RELOAD_OPTION);

    /*
    * Set a reset value for the timer counter such that it will expire
    * earlier than letting it roll over from 0, the reset value is loaded
    * into the timer counter when it is started
    */
    XTmrCtr_SetResetValue(TmrCtrInstancePtr, TmrCtrNumber, SCRUB_PERIOD);

    /*
    * Start the timer counter such that it's incrementing by default,
    * then wait for it to timeout a number of times
    */
    XTmrCtr_Start(&TimerCounterInst, TIMER_CNTR_0);

    ...
}

```

See [Scrubbing](#) for further details on how scrubbing is implemented, including how to calculate the scrubbing rate.

BRAM Driver

The standalone BSP BRAM driver is used to access the ECC registers in the LMB BRAM Interface Controller, and also provides a comprehensive self test.

By implementing the Vitis C Project "Peripheral Tests", a self-test example including the BRAM self test for each LMB BRAM Interface Controller in the system is generated. Depending on the ECC features enabled in the LMB BRAM Interface Controller, this code will perform all possible tests of the ECC function. See the *Vitis Unified Software Platform Documentation Landing Page (UG1416)* for more information.

The self-test example can be found in the standalone BSP BRAM driver source code, typically in the subdirectory `microblaze_0/libsrc/bram_v3_03_a/src/xbram_selftest.c`.

Scrubbing

Scrubbing Methods

Scrubbing is performed using specific methods for the different block RAMs:

- Instruction and data caches: All lines in the caches are cyclically invalidated using the WIC and WDC instructions respectively. This forces the cache to reload the cache line from external memory.

- Memory Management Unit UTLB: All entries in the UTLB are cyclically invalidated by writing the TLBHI register with the valid bit cleared.
- Branch Target Cache: The entire BTC is invalidated by doing a synchronizing branch, BRI 4.
- LMB block RAM: All addresses in the memory are cyclically read and written, thus correcting any single bit errors on each address.

It is also possible to add interrupts for correctable errors from the LMB BRAM Interface Controllers, and immediately scrub this address in the interrupt handler, although in most cases it only improves reliability slightly.

The failing address can be determined by reading the Correctable Error First Failing Address Register in each of the LMB BRAM Interface Controllers.

To be able to generate an interrupt `C_ECC_STATUS_REGISTERS` must be set to 1 in the connected LMB BRAM Interface Controllers, and to read the failing address `C_CE_FAILING_REGISTERS` must be set to 1.

Calculating Scrubbing Rate

The scrubbing rate depends on failure intensity and desired reliability.

The approximate equation to determine the LMB memory scrubbing rate is given by the following equation.

Equation 4: LMB Memory Scrubbing

$$P_W \approx 760 \left(\frac{BER^2}{SR^2} \right)$$

where P_W is the probability of an uncorrectable error in a memory word, BER is the soft error rate for a single memory bit, and SR is the Scrubbing Rate.

The soft error rates affecting block RAM for each product family can be found in the *Device Reliability Report* ([UG116](#)).

Use Cases

Several common use cases are described here. These use cases are derived from the *LMB BRAM Interface Controller LogiCORE IP Product Guide* ([PG112](#)).

Minimal

This system is obtained when enabling fault tolerance in MicroBlaze, without doing any other configuration.

The system is suitable when area constraints are high, and there is no need for testing of the ECC function, or analysis of error frequency and location. No ECC registers are implemented. Single bit errors are corrected by the ECC logic before being passed to MicroBlaze. Uncorrectable errors set an error signal, which generates an exception in MicroBlaze.

Small

This system should be used when it is necessary to monitor error frequency, but there is no need for testing of the ECC function. It is a minimal system with Correctable Error Counter Register added to monitor single bit error rates. If the error rate is too high, the scrubbing rate should be increased to minimize the risk of a single bit error becoming an uncorrectable double bit error. Parameters set are `C_ECC = 1` and `C_CE_COUNTER_WIDTH = 10`.

Typical

This system represents a typical use case, where it is required to monitor error frequency, as well as generating an interrupt to immediately correct a single bit error through software. It does not provide support for testing of the ECC function.

It is a small system with Correctable Error First Failing registers and Status register added. A single bit error will latch the address for the access into the Correctable Error First Failing Address Register and set the `CE_STATUS` bit in the ECC Status Register. An interrupt will be generated triggering MicroBlaze to read the failing address and then perform a read followed by a write on the failing address. This will remove the single bit error from the BRAM, thus reducing the risk of the single bit error becoming a uncorrectable double bit error. Parameters set are:

- `C_ECC = 1`
- `C_CE_COUNTER_WIDTH = 10`
- `C_ECC_STATUS_REGISTER = 1`
- `C_CE_FAILING_REGISTERS = 1`

Full

This system uses all of the features provided by the LMB BRAM Interface Controller, to enable full error injection capability, as well as error monitoring and interrupt generation. It is a typical system with Uncorrectable Error First Failing registers and Fault Injection registers added. All features are switched on for full control of ECC functionality for system debug or systems with high fault tolerance requirements. Parameters set are:

- `C_ECC = 1`
- `C_CE_COUNTER_WIDTH = 10`
- `C_ECC_STATUS_REGISTER = 1`
- `C_CE_FAILING_REGISTERS = 1`

- `C_UE_FAILING_REGISTERS = 1`
- `C_FAULT_INJECT = 1`

Lockstep Operation

MicroBlaze is able to operate in a lockstep configuration, where two or more identical MicroBlaze cores execute the same program. By comparing the outputs of the cores, any tampering attempts, transient faults or permanent hardware faults can be detected.

System Configuration

The parameter `C_LOCKSTEP_SLAVE` is set to one on all slave MicroBlaze cores in the system, except the master (or primary) core. The master core drives all the output signals, and handles the debug functionality. The port `Lockstep_Master_Out` on the master is connected to the port `Lockstep_Slave_In` on the slaves, to handle debugging. The parameter `C_TEMPORAL_DEPTH` is provided to support debugging with temporal lockstep, where the slave core execution is delayed a defined number of clock cycles.

The slave cores should not drive any output signals, only receive input signals. This must be ensured by only connecting signals to the input ports of the slaves. For buses this either means that monitor interfaces must be used, or that each individual input port must be explicitly connected.

The port `Lockstep_Out` on the master and slave cores provide all output signals for comparison. Unless an error occurs, individual signals from each of the cores are identical every clock cycle.

To ensure that lockstep operation works properly, all input signals to the cores must be synchronous. Input signals that could require external synchronization are `Interrupt`, `Reset`, `Ext_Brk`, and `Ext_Nm_Brk`.

Use Cases

Two common use cases are described here. In addition, lockstep operation provides the basis for implementing triple modular redundancy on MicroBlaze core level.

Tamper Protection

This application represents a high assurance use case, where it is required that the system is tamper-proof. A typically example is a cryptographic application.

The approach involves having two redundant MicroBlaze processors with dedicated local memory and redundant comparators, each in a protected area. The outputs from each processor feed two comparators and each processor receive copies of every input signal.

The redundant MicroBlaze processors are functionally identical and completely independent of each other, without any connecting signals. The only exception is debug logic and associated signals, because it is assumed that debugging is disabled before any productization and certification of the system.

The outputs from the master MicroBlaze core drive the peripherals in the system. All data leaving the protected area pass through inhibitors. Each inhibitor is controlled from its associated comparator.

Each protected area of the design must be implemented in its own partition, using a hierarchical single chip cryptography (SCC) flow. A detailed explanation of this flow, and further references, can be found in the *Hierarchical Design Methodology Guide* (UG748).

A block diagram of the system is shown in the following figure.

Figure 45: Lockstep Tamper Protection Application

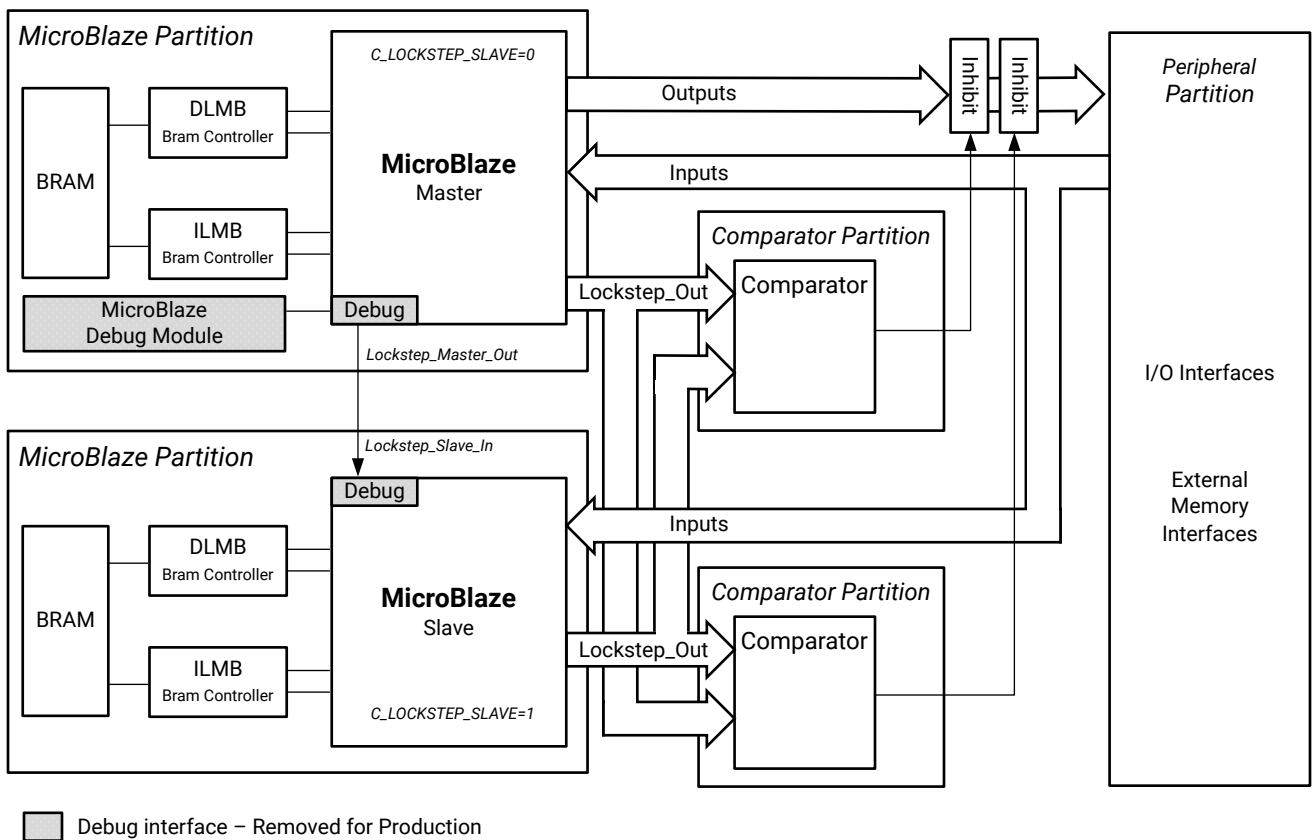

X19777-111617

Error Detection

The error detection use case requires that all transient and permanent faults are detected. This is essential in fail safe and fault tolerant applications, where redundancy is used to improve system availability.

In this system two redundant MicroBlaze processors run in lockstep. A comparator is used to signal an error when a mis-match is detected on the outputs of the two processors. Any error immediately causes both processors to halt, preventing further error propagation.

The redundant MicroBlaze processors are functionally identical, except for debug logic and associated signals. The outputs from the master MicroBlaze core drive the peripherals in the system. The slave MicroBlaze core only has inputs connected; all outputs are left open.

The system contains the basic building block for designing a complete fault tolerant application, where one or more additional blocks must be added to provide redundancy.

This use case is illustrated in the following figure.

Figure 46: Lockstep Error Detection Application

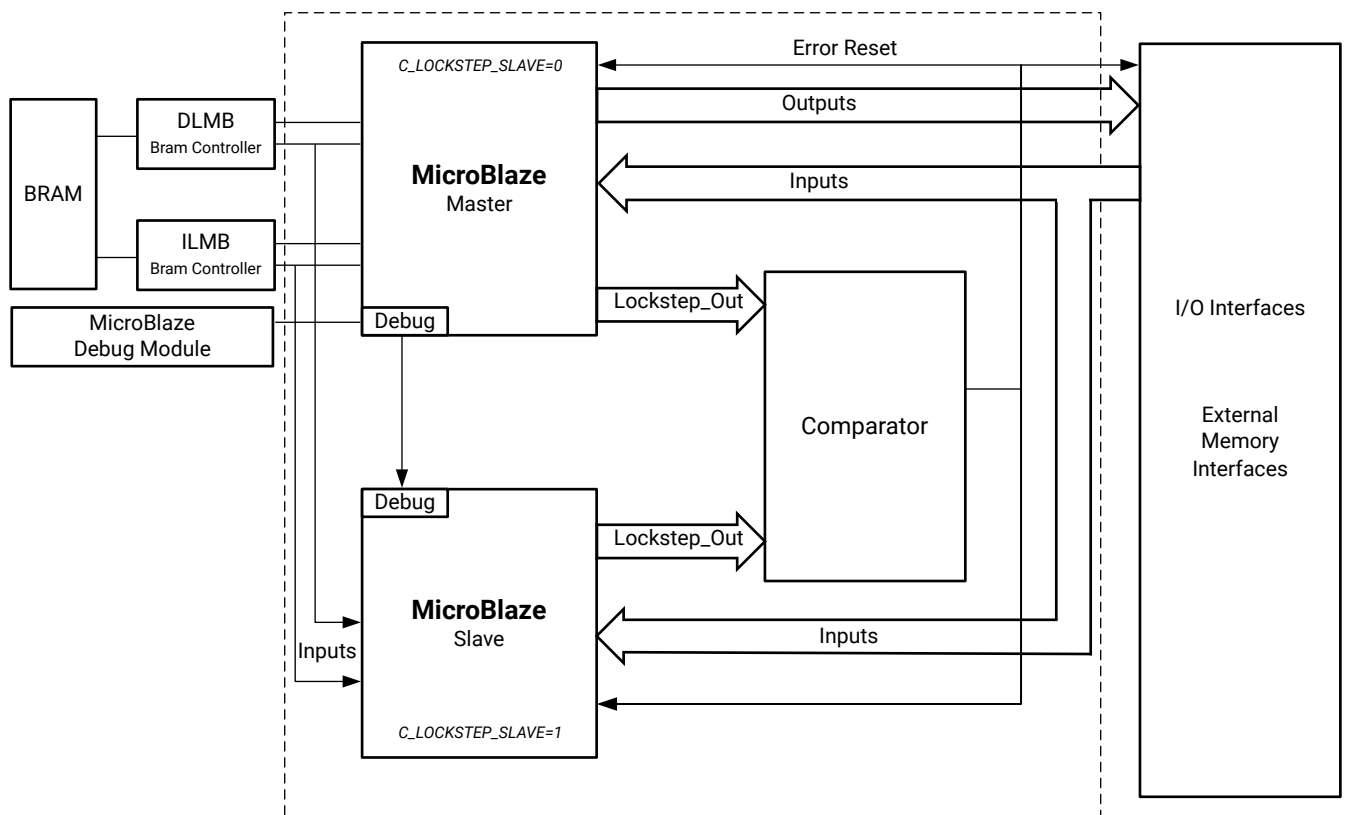

X19778-111617

Coherency

MicroBlaze supports cache coherency, as well as invalidation of caches and translation look-aside buffers, using the AXI Coherency Extension (ACE) defined in *AMBA AXI and ACE Protocol Specification (ARM IHI0022E)* AXI and ACE Protocol Specification (Arm IHI 0022E). The coherency support is enabled when the parameter `C_INTERCONNECT` is set to 3 (ACE).

Using ACE ensures coherency between the caches of all MicroBlaze processors in the coherency domain. The peripheral ports (`AXI_IP`, `AXI_DP`) and local memory (ILMB, DLMB) are outside the coherency domain.

Coherency is not supported with write-back data cache, wide cache interfaces (more than 32-bit data), instruction cache streams, instruction cache victims or when area optimization is enabled. In addition both `C_ICACHE_ALWAYS_USED` and `C_DCACHE_ALWAYS_USED` must be set to 1.

Invalidation

The coherency hardware handles invalidation in the following cases:

- **Data Cache invalidation:** When a MicroBlaze core in the coherency domain invalidates a data cache line with an external cache invalidation instruction (`WDC_EXT_CLEAR` or `WDC_EXT_FLUSH`), hardware messages ensure that all other cores in the coherency domain will do the same. The physical address is always used.
- **Instruction Cache invalidation:** When a MicroBlaze core in the coherency domain invalidates an instruction cache line, hardware messages ensure that all other cores in the coherency domain will do the same. When the MMU is in virtual mode the virtual address is used, otherwise the physical address is used.
- **MMU TLB invalidation:** When a MicroBlaze core in the coherency domain invalidates an entry in the UTLB (that is writes TLBHI with a zero Valid flag), hardware messages ensure that all other cores in the coherency domain will invalidate all entries in their unified TLBs having a TAG matching the invalidated virtual address, as well as empty their shadow TLBs.

The TID is not taken into account when matching the entries, which can result in invalidation of entries belonging to other processes. Subsequent accesses to these entries will generate TLB miss exceptions, which must be handled by software.

Before invalidating an MMU page, it must first be loaded into the UTLB to ensure that the hardware invalidation is propagated within the coherency domain. It is not sufficient to simply invalidate the page in memory, because other processors in the coherency domain can have this particular entry stored in their TLBs.

After a MicroBlaze core has invalidated one or more entries, it must execute a memory barrier instruction (MBAR), to ensure that all peer processors have completed their TLB invalidation.

- **Branch Target Cache invalidation:** When a MicroBlaze core in the coherency domain invalidates the Branch Target Cache, either with a memory barrier instruction or with a synchronizing branch, hardware messages ensure that all other cores in the coherency domain will do the same.

In particular, this means that self-modifying code can be used transparently within the coherency domain in a multi-processor system, provided that the guidelines in [Self-Modifying Code](#) are followed.

Protocol Compliance

The MicroBlaze instruction cache interface issues the following subset of the possible ACE transactions:

- **ReadClean:** Issued when a cache line is allocated.
- **ReadOnce:** Issued when the cache is off, or if the MMU Inhibit Caching bit is set for the cache line.

The MicroBlaze data cache interface issues the following subset of the possible ACE transactions:

- **ReadClean:** Issued when a cache line is allocated.
- **CleanUnique:** Issued when an SWX instruction is executed as part of an exclusive access sequence.
- **ReadOnce:** Issued when the cache is off, or if the MMU Inhibit Caching bit is set for the cache line.
- **WriteUnique:** Issued whenever a store instruction performs a write.
- **CleanInvalid:** Issued when a `WDC . EXT . FLUSH` instruction is executed.
- **MakeInvalid:** Issued when a `WDC . EXT . CLEAR` instruction is executed.

Both interfaces issue the following subset of the possible Distributed Virtual Memory (DVM) transactions:

- **DVM Operation:**
 - **TLB Invalidate:** Hypervisor TLB Invalidate by VA
 - **Branch Predictor Invalidate:** L Branch Predictor Invalidate all
 - **Physical Instruction Cache Invalidate:** Non-secure Physical Instruction Cache Invalidate by PA without Virtual Index
 - **Virtual Instruction Cache Invalidate:** Hypervisor Invalidate by VA
- **DVM Sync:** Synchronization

- **DVM Complete:**
 - In addition to the DVM transactions above, the interfaces only accept the `CleanInvalid` and `MakeInvalid` transactions. These transactions have no effect in the instruction cache, and invalidate the indicated data cache lines. If any other transactions are received, the behavior is undefined.
 - Only a subset of AXI4 transactions are used by the interfaces, as described in [Cache Interfaces](#).

Data and Instruction Address Extension

MicroBlaze has the ability to address up to 16 EB of data controlled by the parameter `C_ADDR_SIZE`, and with 32-bit MicroBlaze also supports a physical instruction address up to 16 EB when the MMU Physical Address Extension (PAE) is enabled by setting `C_USE_MMU = 3` (Virtual).

With 64-bit MicroBlaze both the virtual and physical address are extended according to the parameter `C_ADDR_SIZE`. This applies to both instruction and data address spaces, thus eliminating all limitations imposed by using 32-bit MicroBlaze listed here.

The parameter `C_ADDR_SIZE` can be set to the following values:

NONE	$4 * 1024^3$ bytes	32-bit address, no extended address instructions or PAE
64 GB	$64 * 1024^3$ bytes	36-bit address
1TB	1024^4 bytes	40-bit address
16 TB	$16 * 1024^4$ bytes	44-bit address
256 TB	$256 * 1024^4$ bytes	48-bit address
4 PB	$4 * 1024^5$ bytes	52-bit address
16 EB	$16 * 1024^6$ bytes	64-bit address

There are a number of software limitations with extended addressing when using 32-bit MicroBlaze:

- The GNU tools only generate ELF files with 32-bit addresses with 32-bit MicroBlaze, which means that program instruction and data memory must be located in the first 4 GB of the address space. This is also the reason the instruction address space does not provide an extended address unless PAE is enabled.

With PAE enabled, the majority of the program instruction and data can be located at any physical address, but all software running in real mode must be located in the first 4 GB of the address space. The `MMU_UTLB` must also be initialized to set up the virtual to physical address translation by software running in real mode, before virtual mode is activated.

- Because all software drivers use address pointers that are 32-bit unsigned integers, it is not possible to access physical extended addresses above 4 GB without modifying the driver code, and consequently all AXI peripherals should be located in the first 4 GB of the address space.

With PAE enabled, AXI peripherals can be located at any physical address, provided that the virtual address remains in the first 4 GB of the address space.

- The extended address is only treated as a physical address, and the MMU cannot be used to translate from an extended virtual address to a physical address.

This also means that without PAE support, Linux can only use the data address extension through a dedicated driver operating in real mode.

The extended address load and store instructions are privileged when the MMU is enabled, unless they are allowed by setting the parameter `C_MMU_PRIVILEGED_INSTR` appropriately. If allowed, the instructions bypass the MMU translation treating the extended address as a physical address.

- The GNU compiler does not handle 64-bit address pointers, which means that unless PAE is enabled the only way to access an extended address is using the specific extended addressing instructions, available as macros.

The following C code exemplifies how an extended address can be used to access data:

```
#include "xil_types.h"
#include "mb_interface.h"
int main()
{
    u64 Addr = 0x000000FF00000000LL; /* Extended address */
    u32 Word;
    u8 Byte;

    Word = lwea(Addr); /* Load word from extended address */
    swea(Addr, Word); /* Store word to extended address */
    Byte = lbuea(Addr); /* Load byte from extended address */
    sbea(Addr, Byte); /* Store byte to extended address */
}
```

MicroBlaze Signal Interface Description

Introduction

This chapter describes the types of signal interfaces that can be used to connect a MicroBlaze™ processor.

Overview

The MicroBlaze core is organized as a Harvard architecture with separate bus interface units for data and instruction accesses. The following two memory interfaces are supported: Local Memory Bus (LMB), and the AMBA® AXI4 interface (AXI4) and ACE interface (ACE).

The LMB provides single-cycle access to on-chip dual-port block RAM. The AXI4 interfaces provide a connection to both on-chip and off-chip peripherals and memory. The ACE interfaces provide cache coherent connections to memory.

MicroBlaze also supports up to 16 AXI4-Stream interface ports, each with one master and one slave interface.

Features

MicroBlaze can be configured with the following bus interfaces:

- The AMBA AXI4 Interface for peripheral interfaces, and the AMBA AXI4 or AXI Coherency Extension (ACE) Interface for cache interfaces (see Arm® *AMBA AXI and ACE Protocol Specification*, [Arm IHI 0022E](#)).
- LMB provides a simple synchronous protocol for efficient block RAM transfers
- AXI4-Stream provides a fast non-arbitrated streaming communication mechanism
- Debug interface for use with the MicroBlaze Debug Module (MDM) core
- Trace interface for performance analysis

MicroBlaze I/O Overview

The core interfaces shown in the following figure and [Table 66: Summary of MicroBlaze Core I/O](#) are defined as follows:

- **M_AXI_DP**: Peripheral Data Interface, AXI4-Lite or AXI4 interface
- **DLMB**: Data interface, Local Memory Bus (BRAM only)
- **M_AXI_IP**: Peripheral Instruction interface, AXI4-Lite interface
- **ILMB**: Instruction interface, Local Memory Bus (BRAM only)
- **M0_AXIS..M15_AXIS**: AXI4-Stream interface master direct connection interfaces
- **S0_AXIS..S15_AXIS**: AXI4-Stream interface slave direct connection interfaces
- **M_AXI_DC**: Data-side cache AXI4 interface
- **M_ACE_DC**: Data-side cache AXI Coherency Extension (ACE) interface
- **M_AXI_IC**: Instruction-side cache AXI4 interface
- **M_ACE_IC**: Instruction-side cache AXI Coherency Extension (ACE) interface
- **Core**: Miscellaneous signals for: clock, reset, interrupt, debug, trace

Figure 47: MicroBlaze Core Block Diagram

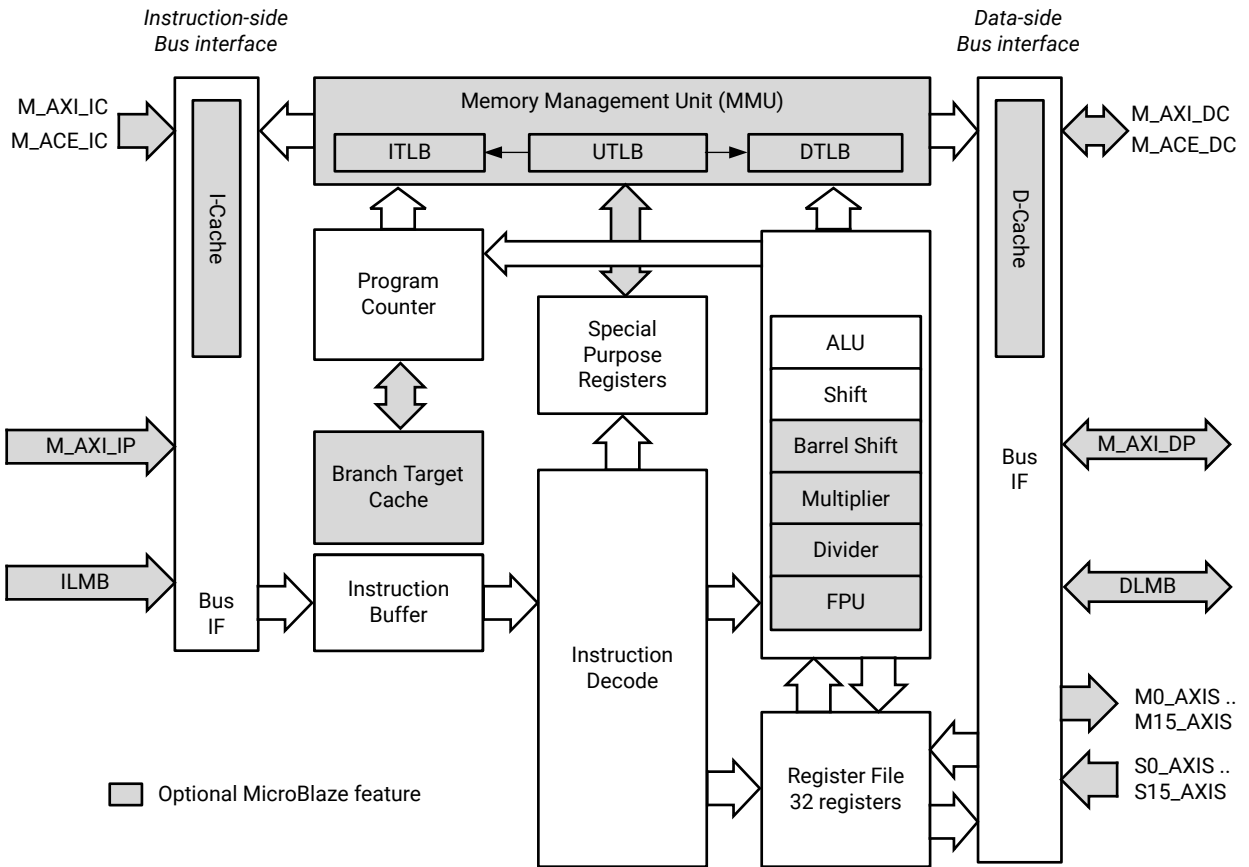

X19738-100218

Table 66: Summary of MicroBlaze Core I/O

Signal	Interface	I/O	Description
M_AXI_DP_AWID	M_AXI_DP	O	Master Write address ID
M_AXI_DP_AWADDR	M_AXI_DP	O	Master Write address
M_AXI_DP_AWLEN	M_AXI_DP	O	Master Burst length
M_AXI_DP_AWSIZE	M_AXI_DP	O	Master Burst size
M_AXI_DP_AWBURST	M_AXI_DP	O	Master Burst type
M_AXI_DP_AWLOCK	M_AXI_DP	O	Master Lock type
M_AXI_DP_AWCACHE	M_AXI_DP	O	Master Cache type
M_AXI_DP_AWPROT	M_AXI_DP	O	Master Protection type
M_AXI_DP_AWQOS	M_AXI_DP	O	Master Quality of Service
M_AXI_DP_AWVALID	M_AXI_DP	O	Master Write address valid
M_AXI_DP_AWREADY	M_AXI_DP	I	Slave Write address ready
M_AXI_DP_WDATA	M_AXI_DP	O	Master Write data
M_AXI_DP_WSTRB	M_AXI_DP	O	Master Write strobes
M_AXI_DP_WLAST	M_AXI_DP	O	Master Write last

Table 66: Summary of MicroBlaze Core I/O (cont'd)

Signal	Interface	I/O	Description
M_AXI_DP_WVALID	M_AXI_DP	O	Master Write valid
M_AXI_DP_WREADY	M_AXI_DP	I	Slave Write ready
M_AXI_DP_BID	M_AXI_DP	I	Slave Response ID
M_AXI_DP_BRESP	M_AXI_DP	I	Slave Write response
M_AXI_DP_BVALID	M_AXI_DP	I	Slave Write response valid
M_AXI_DP_BREADY	M_AXI_DP	O	Master Response ready
M_AXI_DP_ARID	M_AXI_DP	O	Master Read address ID
M_AXI_DP_ARADDR	M_AXI_DP	O	Master Read address
M_AXI_DP_ARLEN	M_AXI_DP	O	Master Burst length
M_AXI_DP_ARSIZE	M_AXI_DP	O	Master Burst size
M_AXI_DP_ARBURST	M_AXI_DP	O	Master Burst type
M_AXI_DP_ARLOCK	M_AXI_DP	O	Master Lock type
M_AXI_DP_ARCACHE	M_AXI_DP	O	Master Cache type
M_AXI_DP_ARPROT	M_AXI_DP	O	Master Protection type
M_AXI_DP_ARQOS	M_AXI_DP	O	Master Quality of Service
M_AXI_DP_ARVALID	M_AXI_DP	O	Master Read address valid
M_AXI_DP_ARREADY	M_AXI_DP	I	Slave Read address ready
M_AXI_DP_RID	M_AXI_DP	I	Slave Read ID tag
M_AXI_DP_RDATA	M_AXI_DP	I	Slave Read data
M_AXI_DP_RRESP	M_AXI_DP	I	Slave Read response
M_AXI_DP_RLAST	M_AXI_DP	I	Slave Read last
M_AXI_DP_RVALID	M_AXI_DP	I	Slave Read valid
M_AXI_DP_RREADY	M_AXI_DP	O	Master Read ready
M_AXI_IP_AWID	M_AXI_IP	O	Master Write address ID
M_AXI_IP_AWADDR	M_AXI_IP	O	Master Write address
M_AXI_IP_AWLEN	M_AXI_IP	O	Master Burst length
M_AXI_IP_AWSIZE	M_AXI_IP	O	Master Burst size
M_AXI_IP_AWBURST	M_AXI_IP	O	Master Burst type
M_AXI_IP_AWLOCK	M_AXI_IP	O	Master Lock type
M_AXI_IP_AWCACHE	M_AXI_IP	O	Master Cache type
M_AXI_IP_AWPROT	M_AXI_IP	O	Master Protection type
M_AXI_IP_AWQOS	M_AXI_IP	O	Master Quality of Service
M_AXI_IP_AWVALID	M_AXI_IP	O	Master Write address valid
M_AXI_IP_AWREADY	M_AXI_IP	I	Slave Write address ready
M_AXI_IP_WDATA	M_AXI_IP	O	Master Write data
M_AXI_IP_WSTRB	M_AXI_IP	O	Master Write strobes
M_AXI_IP_WLAST	M_AXI_IP	O	Master Write last
M_AXI_IP_WVALID	M_AXI_IP	O	Master Write valid
M_AXI_IP_WREADY	M_AXI_IP	I	Slave Write ready

Table 66: Summary of MicroBlaze Core I/O (cont'd)

Signal	Interface	I/O	Description
M_AXI_IP_BID	M_AXI_IP	I	Slave Response ID
M_AXI_IP_BRESP	M_AXI_IP	I	Slave Write response
M_AXI_IP_BVALID	M_AXI_IP	I	Slave Write response valid
M_AXI_IP_BREADY	M_AXI_IP	O	Master Response ready
M_AXI_IP_ARID	M_AXI_IP	O	Master Read address ID
M_AXI_IP_ARADDR	M_AXI_IP	O	Master Read address
M_AXI_IP_ARLEN	M_AXI_IP	O	Master Burst length
M_AXI_IP_ARSIZE	M_AXI_IP	O	Master Burst size
M_AXI_IP_ARBURST	M_AXI_IP	O	Master Burst type
M_AXI_IP_ARLOCK	M_AXI_IP	O	Master Lock type
M_AXI_IP_ARCACHE	M_AXI_IP	O	Master Cache type
M_AXI_IP_ARPROT	M_AXI_IP	O	Master Protection type
M_AXI_IP_ARQOS	M_AXI_IP	O	Master Quality of Service
M_AXI_IP_ARVALID	M_AXI_IP	O	Master Read address valid
M_AXI_IP_ARREADY	M_AXI_IP	I	Slave Read address ready
M_AXI_IP_RID	M_AXI_IP	I	Slave Read ID tag
M_AXI_IP_RDATA	M_AXI_IP	I	Slave Read data
M_AXI_IP_RRESP	M_AXI_IP	I	Slave Read response
M_AXI_IP_RLAST	M_AXI_IP	I	Slave Read last
M_AXI_IP_RVALID	M_AXI_IP	I	Slave Read valid
M_AXI_IP_RREADY	M_AXI_IP	O	Master Read ready
M_AXI_DC_AWADDR	M_AXI_DC	O	Master Write address
M_AXI_DC_AWLEN	M_AXI_DC	O	Master Burst length
M_AXI_DC_AWSIZE	M_AXI_DC	O	Master Burst size
M_AXI_DC_AWBURST	M_AXI_DC	O	Master Burst type
M_AXI_DC_AWLOCK	M_AXI_DC	O	Master Lock type
M_AXI_DC_AWCACHE	M_AXI_DC	O	Master Cache type
M_AXI_DC_AWPROT	M_AXI_DC	O	Master Protection type
M_AXI_DC_AWQOS	M_AXI_DC	O	Master Quality of Service
M_AXI_DC_AWVALID	M_AXI_DC	O	Master Write address valid
M_AXI_DC_AWREADY	M_AXI_DC	I	Slave Write address ready
M_AXI_DC_AWUSER	M_AXI_DC	O	Master Write address user signals
M_AXI_DC_AWDOMAIN	M_ACE_DC	O	Master Write address domain
M_AXI_DC_AWSNOOP	M_ACE_DC	O	Master Write address snoop
M_AXI_DC_AWBAR	M_ACE_DC	O	Master Write address barrier
M_AXI_DC_WDATA	M_AXI_DC	O	Master Write data
M_AXI_DC_WSTRB	M_AXI_DC	O	Master Write strobes
M_AXI_DC_WLAST	M_AXI_DC	O	Master Write last
M_AXI_DC_WVALID	M_AXI_DC	O	Master Write valid

Table 66: Summary of MicroBlaze Core I/O (cont'd)

Signal	Interface	I/O	Description
M_AXI_DC_WREADY	M_AXI_DC	I	Slave Write ready
M_AXI_DC_WUSER	M_AXI_DC	O	Master Write user signals
M_AXI_DC_BRESP	M_AXI_DC	I	Slave Write response
M_AXI_DC_BID	M_AXI_DC	I	Slave Response ID
M_AXI_DC_BVALID	M_AXI_DC	I	Slave Write response valid
M_AXI_DC_BREADY	M_AXI_DC	O	Master Response ready
M_AXI_DC_BUSER	M_AXI_DC	I	Slave Write response user signals
M_AXI_DC_WACK	M_ACE_DC	O	Slave Write acknowledge
M_AXI_DC_ARID	M_AXI_DC	O	Master Read address ID
M_AXI_DC_ARADDR	M_AXI_DC	O	Master Read address
M_AXI_DC_ARLEN	M_AXI_DC	O	Master Burst length
M_AXI_DC_ARSIZE	M_AXI_DC	O	Master Burst size
M_AXI_DC_ARBURST	M_AXI_DC	O	Master Burst type
M_AXI_DC_ARLOCK	M_AXI_DC	O	Master Lock type
M_AXI_DC_ARCACHE	M_AXI_DC	O	Master Cache type
M_AXI_DC_ARPROT	M_AXI_DC	O	Master Protection type
M_AXI_DC_ARQOS	M_AXI_DC	O	Master Quality of Service
M_AXI_DC_ARVALID	M_AXI_DC	O	Master Read address valid
M_AXI_DC_ARREADY	M_AXI_DC	I	Slave Read address ready
M_AXI_DC_ARUSER	M_AXI_DC	O	Master Read address user signals
M_AXI_DC_ARDOMAIN	M_ACE_DC	O	Master Read address domain
M_AXI_DC_ARSNOOP	M_ACE_DC	O	Master Read address snoop
M_AXI_DC_ARBAR	M_ACE_DC	O	Master Read address barrier
M_AXI_DC_RID	M_AXI_DC	I	Slave Read ID tag
M_AXI_DC_RDATA	M_AXI_DC	I	Slave Read data
M_AXI_DC_RRESP	M_AXI_DC	I	Slave Read response
M_AXI_DC_RLAST	M_AXI_DC	I	Slave Read last
M_AXI_DC_RVALID	M_AXI_DC	I	Slave Read valid
M_AXI_DC_RREADY	M_AXI_DC	O	Master Read ready
M_AXI_DC_RUSER	M_AXI_DC	I	Slave Read user signals
M_AXI_DC_RACK	M_ACE_DC	O	Master Read acknowledge
M_AXI_DC_ACVALID	M_ACE_DC	I	Slave Snoop address valid
M_AXI_DC_ACADDR	M_ACE_DC	I	Slave Snoop address
M_AXI_DC_ACSNOOP	M_ACE_DC	I	Slave Snoop address snoop
M_AXI_DC_ACPROT	M_ACE_DC	I	Slave Snoop address protection type
M_AXI_DC_ACREADY	M_ACE_DC	O	Master Snoop ready
M_AXI_DC_CRREADY	M_ACE_DC	I	Slave Snoop response ready
M_AXI_DC_CRVALID	M_ACE_DC	O	Master Snoop response valid
M_AXI_DC_CRRESP	M_ACE_DC	O	Master Snoop response

Table 66: Summary of MicroBlaze Core I/O (cont'd)

Signal	Interface	I/O	Description
M_AXI_DC_CDVALID	M_ACE_DC	O	Master Snoop data valid
M_AXI_DC_CDREADY	M_ACE_DC	I	Slave Snoop data ready
M_AXI_DC_CDDATA	M_ACE_DC	O	Master Snoop data
M_AXI_DC_CDLAST	M_ACE_DC	O	Master Snoop data last
M_AXI_IC_AWID	M_AXI_IC	O	Master Write address ID
M_AXI_IC_AWADDR	M_AXI_IC	O	Master Write address
M_AXI_IC_AWLEN	M_AXI_IC	O	Master Burst length
M_AXI_IC_AWSIZE	M_AXI_IC	O	Master Burst size
M_AXI_IC_AWBURST	M_AXI_IC	O	Master Burst type
M_AXI_IC_AWLOCK	M_AXI_IC	O	Master Lock type
M_AXI_IC_AWCACHE	M_AXI_IC	O	Master Cache type
M_AXI_IC_AWPROT	M_AXI_IC	O	Master Protection type
M_AXI_IC_AWQOS	M_AXI_IC	O	Master Quality of Service
M_AXI_IC_AWVALID	M_AXI_IC	O	Master Write address valid
M_AXI_IC_AWREADY	M_AXI_IC	I	Slave Write address ready
M_AXI_IC_AWUSER	M_AXI_IC	O	Master Write address user signals
M_AXI_IC_AWDOMAIN	M_ACE_IC	O	Master Write address domain
M_AXI_IC_AWSNOOP	M_ACE_IC	O	Master Write address snoop
M_AXI_IC_AWBAR	M_ACE_IC	O	Master Write address barrier
M_AXI_IC_WDATA	M_AXI_IC	O	Master Write data
M_AXI_IC_WSTRB	M_AXI_IC	O	Master Write strobes
M_AXI_IC_WLAST	M_AXI_IC	O	Master Write last
M_AXI_IC_WVALID	M_AXI_IC	O	Master Write valid
M_AXI_IC_WREADY	M_AXI_IC	I	Slave Write ready
M_AXI_IC_WUSER	M_AXI_IC	O	Master Write user signals
M_AXI_IC_BID	M_AXI_IC	I	Slave Response ID
M_AXI_IC_BRESP	M_AXI_IC	I	Slave Write response
M_AXI_IC_BVALID	M_AXI_IC	I	Slave Write response valid
M_AXI_IC_BREADY	M_AXI_IC	O	Master Response ready
M_AXI_IC_BUSER	M_AXI_IC	I	Slave Write response user signals
M_AXI_IC_WACK	M_ACE_IC	O	Slave Write acknowledge
M_AXI_IC_ARID	M_AXI_IC	O	Master Read address ID
M_AXI_IC_ARADDR	M_AXI_IC	O	Master Read address
M_AXI_IC_ARLEN	M_AXI_IC	O	Master Burst length
M_AXI_IC_ARSIZE	M_AXI_IC	O	Master Burst size
M_AXI_IC_ARBURST	M_AXI_IC	O	Master Burst type
M_AXI_IC_ARLOCK	M_AXI_IC	O	Master Lock type
M_AXI_IC_ARCACHE	M_AXI_IC	O	Master Cache type
M_AXI_IC_ARPROT	M_AXI_IC	O	Master Protection type

Table 66: Summary of MicroBlaze Core I/O (cont'd)

Signal	Interface	I/O	Description
M_AXI_IC_ARQOS	M_AXI_IC	O	Master Quality of Service
M_AXI_IC_ARVALID	M_AXI_IC	O	Master Read address valid
M_AXI_IC_ARREADY	M_AXI_IC	I	Slave Read address ready
M_AXI_IC_ARUSER	M_AXI_IC	O	Master Read address user signals
M_AXI_IC_ARDOMAIN	M_ACE_IC	O	Master Read address domain
M_AXI_IC_ARSNOOP	M_ACE_IC	O	Master Read address snoop
M_AXI_IC_ARBAR	M_ACE_IC	O	Master Read address barrier
M_AXI_IC_RID	M_AXI_IC	I	Slave Read ID tag
M_AXI_IC_RDATA	M_AXI_IC	I	Slave Read data
M_AXI_IC_RRESP	M_AXI_IC	I	Slave Read response
M_AXI_IC_RLAST	M_AXI_IC	I	Slave Read last
M_AXI_IC_RVALID	M_AXI_IC	I	Slave Read valid
M_AXI_IC_RREADY	M_AXI_IC	O	Master Read ready
M_AXI_IC_RUSER	M_AXI_IC	I	Slave Read user signals
M_AXI_IC_RACK	M_ACE_IC	O	Master Read acknowledge
M_AXI_IC_ACVALID	M_ACE_IC	I	Slave Snoop address valid
M_AXI_IC_ACADDR	M_ACE_IC	I	Slave Snoop address
M_AXI_IC_ACSNOOP	M_ACE_IC	I	Slave Snoop address snoop
M_AXI_IC_ACPROT	M_ACE_IC	I	Slave Snoop address protection type
M_AXI_IC_ACREADY	M_ACE_IC	O	Master Snoop ready
M_AXI_IC_CRREADY	M_ACE_IC	I	Slave Snoop response ready
M_AXI_IC_CRVALID	M_ACE_IC	O	Master Snoop response valid
M_AXI_IC_CRRESP	M_ACE_IC	O	Master Snoop response
M_AXI_IC_CDVALID	M_ACE_IC	O	Master Snoop data valid
M_AXI_IC_CDREADY	M_ACE_IC	I	Slave Snoop data ready
M_AXI_IC_CDDATA	M_ACE_IC	O	Master Snoop data
M_AXI_IC_CDLAST	M_ACE_IC	O	Master Snoop data last
Data_Addr[0:N-1]	DLMB	O	Data interface LMB address bus, N = 32 - 64
Byte_Enable[0:N-1]	DLMB	O	Data interface LMB byte enables, N = 4, 8
Data_Write[0:N-1]	DLMB	O	Data interface LMB write data bus, N = 32, 64
D_AS	DLMB	O	Data interface LMB address strobe
Read_Strobe	DLMB	O	Data interface LMB read strobe
Write_Strobe	DLMB	O	Data interface LMB write strobe
Data_Read[0:N-1]	DLMB	I	Data interface LMB read data bus, N = 32, 64
DReady	DLMB	I	Data interface LMB data ready
DWait	DLMB	I	Data interface LMB data wait
DCE	DLMB	I	Data interface LMB correctable error
DUE	DLMB	I	Data interface LMB uncorrectable error
Instr_Addr[0:N-1]	ILMB	O	Instruction interface LMB address bus, N = 32 - 64

Table 66: Summary of MicroBlaze Core I/O (cont'd)

Signal	Interface	I/O	Description
I_AS	ILMB	O	Instruction interface LMB address strobe
IFetch	ILMB	O	Instruction interface LMB instruction fetch
Instr[0:N-1]	ILMB	I	Instruction interface LMB read data bus, N = 32, 64
IReady	ILMB	I	Instruction interface LMB data ready
IWait	ILMB	I	Instruction interface LMB data wait
ICE	ILMB	I	Instruction interface LMB correctable error
IUE	ILMB	I	Instruction interface LMB uncorrectable error
Mn_AXIS_TLAST	M0_AXIS.. M15_AXIS	O	Master interface output AXI4 channels write last
Mn_AXIS_TDATA	M0_AXIS.. M15_AXIS	O	Master interface output AXI4 channels write data
Mn_AXIS_TVALID	M0_AXIS.. M15_AXIS	O	Master interface output AXI4 channels write valid
Mn_AXIS_TREADY	M0_AXIS.. M15_AXIS	I	Master interface input AXI4 channels write ready
Sn_AXIS_TLAST	S0_AXIS.. S15_AXIS	I	Slave interface input AXI4 channels write last
Sn_AXIS_TDATA	S0_AXIS.. S15_AXIS	I	Slave interface input AXI4 channels write data
Sn_AXIS_TVALID	S0_AXIS.. S15_AXIS	I	Slave interface input AXI4 channels write valid
Sn_AXIS_TREADY	S0_AXIS.. S15_AXIS	O	Slave interface output AXI4 channels write ready
Interrupt	Core	I	Interrupt. The signal is synchronized to Clk if the parameter C_ASYNC_INTERRUPT is set.
Interrupt_Address ¹	Core	I	Interrupt vector address
Interrupt_Ack ¹	Core	O	Interrupt acknowledge
Reset	Core	I	Core reset, active-High. Must be asserted 1 Clk clock cycle, but it is recommended to keep it asserted for at least 16 clock cycles.
Reset_Mode[0:1] ³	Core	I	Reset mode. Sampled when Reset is active. See Table 67: Effect of Reset Mode Inputs for details.
Clk	Core	I	Clock ²
Ext_BRK ³	Core	I	Break signal from MDM
Ext_NM_BRK ³	Core	I	Non-maskable break signal from MDM
MB_Halted ³	Core	O	Pipeline is halted, either using the Debug Interface, by setting Dbg_Stop, or by setting Reset_Mode[0:1] to 10.
Dbg_Stop ³	Core	I	Unconditionally force pipeline to halt as soon as possible. Rising-edge detected pulse that should be held for at least 1 Clk clock cycle. The signal only has any effect when C_DEBUG_ENABLED is greater than 0.

Table 66: Summary of MicroBlaze Core I/O (cont'd)

Signal	Interface	I/O	Description
Dbg_Intr ³	Core	O	Debug interrupt output, set when a Performance Monitor counter overflows, available when C_DEBUG_ENABLED is set to 2 (Extended).
MB_Error ³	Core	O	Pipeline is halted due to a missed exception, when C_FAULT_TOLERANT is set to 1.
Sleep ³	Core	O	MicroBlaze is in sleep mode after executing a SLEEP instruction or by setting Reset_Mode[0:1] to 10, all external accesses are completed, and the pipeline is halted.
Hibernate ³	Core	O	MicroBlaze is in sleep mode after executing a HIBERNATE instruction, all external accesses are completed, and the pipeline is halted.
Suspend ³	Core	O	MicroBlaze is in sleep mode after executing a SUSPEND instruction, all external accesses are completed, and the pipeline is halted.
Wakeup[0:1] ³	Core	I	Wake MicroBlaze from sleep mode when either or both bits are set to 1. Ignored if MicroBlaze is not in sleep mode. The signals are individually synchronized to Clk according to the parameter C_ASYNC_WAKEUP[0:1].
Dbg_Wakeup ³	Core	O	Debug request that external logic should wake MicroBlaze from sleep mode with the Wakeup signal, to allow debug access. Synchronous to Dbg_Update.
Pause ³	Core	I	When this signal is set MicroBlaze pipeline will be paused after completing all ongoing bus accesses, and the Pause_Ack signal will be set. When this signal is cleared again MicroBlaze will continue normal execution where it was paused.
Pause_Ack ³	Core	O	MicroBlaze is in pause mode after the Pause input signal has been set.
Dbg_Continue ³	Core	O	Debug request that external logic should clear the Pause signal, to allow debug access.
Non_Secure[0:3] ³	Core	I	Determines whether AXI accesses are non-secure or secure. The default value is binary 0000, setting all interfaces to be secure. Bit 0 = M_AXI_DP Bit 1 = M_AXI_IP Bit 2 = M_AXI_DC Bit 3 = M_AXI_IC
Lockstep_...	Core	IO	Lockstep signals for high integrity applications. See Lockstep Interface Description for details.
Dbg_...	Core	IO	Debug signals from MDM. See Debug Interface Description for details.

Table 66: Summary of MicroBlaze Core I/O (cont'd)

Signal	Interface	I/O	Description
Trace_...	Core	O	Trace signals for real time HW analysis. See Trace Interface Description for details.

Notes:

1. Only used with C_USE_INTERRUPT = 2, for low-latency interrupt support.
2. MicroBlaze is a synchronous design clocked with the Clk signal, except for serial hardware debug logic, which is clocked with the Dbg_Clk signal. If serial hardware debug logic is not used, there is no minimum frequency limit for Clk. However, if serial hardware debug logic is used, there are signals transferred between the two clock regions. In this case Clk must have a higher frequency than Dbg_Clk.
3. Only visible when C_ENABLE_DISCRETE_PORTS = 1.

Table 67: Effect of Reset Mode Inputs

Reset_Mode[0:1]	Description
00	MicroBlaze starts executing at the reset vector, defined by C_BASE_VECTORS. This is the nominal default behavior.
01	MicroBlaze immediately enters sleep mode without performing any bus access, as if a SLEEP instruction had been executed. The Sleep output is set to 1. When any of the Wakeup[0:1] signals is set, MicroBlaze starts executing at the reset vector, defined by C_BASE_VECTORS. This functionality can be useful in a multiprocessor configuration, allowing secondary processors to be configured without LMB memory.
10	If C_DEBUG_ENABLED is 0, the behavior is the same as if Reset_Mode[0:1] = 00. If C_DEBUG_ENABLED is greater than 0, MicroBlaze immediately enters debug halt without performing any bus access, and the MB_Halted output is set to 1. When execution is continued via the debug interface, MicroBlaze starts executing at the reset vector, defined by C_BASE_VECTORS.
11	Reserved

In general, MicroBlaze signals are synchronous to the Clk input signal. However, there are some exceptions controlled by parameters as described in the following table.

Table 68: Parameter Controlled Asynchronous Signals

Signal	Parameter	Default	Description
Interrupt	C_ASYNC_INTERRUPT	Tool controlled	Parameter set from connected signal
Reset	C_NUM_SYNC_FF_CLK	2	Parameter can be manually set to 0 for synchronous reset
Wakeup[0:1]	C_ASYNC_WAKEUP C_NUM_SYNC_FF_CLK	Tool controlled 2	Set from connected signals Can be manually set to 0 to override tool
Dbg_Wakeup	C_DEBUG_INTERFACE	0 (serial)	0: Clocked by Dbg_Update 1: Clocked by DEBUG_ACLK, synchronous to Clk

Sleep and Pause Functionality

There are two distinct ways of halting MicroBlaze execution in a controlled manner:

- Software controlled by executing an MBAR instruction to enter sleep mode.
- Hardware controlled by setting the input signal `Pause` to pause the pipeline.

Software Controlled

When an MBAR instruction is executed to enter sleep mode and MicroBlaze has completed all external accesses, the pipeline is halted and either the Sleep, Hibernate, or Suspend output signal is set.

This indicates to external hardware that it is safe to perform actions such as stopping the clock, resetting the processor or other IP cores. Different actions can be performed depending on which output signal is set. To wake up MicroBlaze when in sleep mode, one (or both) of the Wakeup input signals must be set to one. In this case MicroBlaze continues execution after the MBAR instruction.

The `Dbg_Wakeup` output signal from MicroBlaze indicates that the debugger requests a wake up. External hardware should handle this signal and wake up the processor, after performing any other necessary hardware actions such as starting the clock. If debug wake up is used, the software must be aware that this could be the reason for waking up, and go to sleep again if no other action is required.

In the simplest case, where no additional actions are needed before waking up the processor, one of the Wakeup inputs can be connected to the same signal as the MicroBlaze Interrupt input, and the other to the MicroBlaze `Dbg_Wakeup` output. This allows MicroBlaze to wake up when an interrupt occurs, or when the debugger requests it.

To implement a software reset functionality, for example the Suspend output signal can be connected to a suitable reset input, to either reset the processor or the entire system.

The following table summarizes the MBAR sleep mode instructions.

Table 69: MBAR Sleep Mode Instructions

Instruction	Assembler Pseudo Instruction	Output Signal
mbar 16	sleep	Sleep
mbar 8	hibernate	Hibernate
mbar 24	suspend	Suspend

The block diagram in the following figure illustrates how to use the sleep functionality to implement clock control. In this example, the clock is stopped when sleep is executed and any interrupt or debug command enables the clock and wakes the processor.

Figure 48: Sleep Clock Control Block Diagram

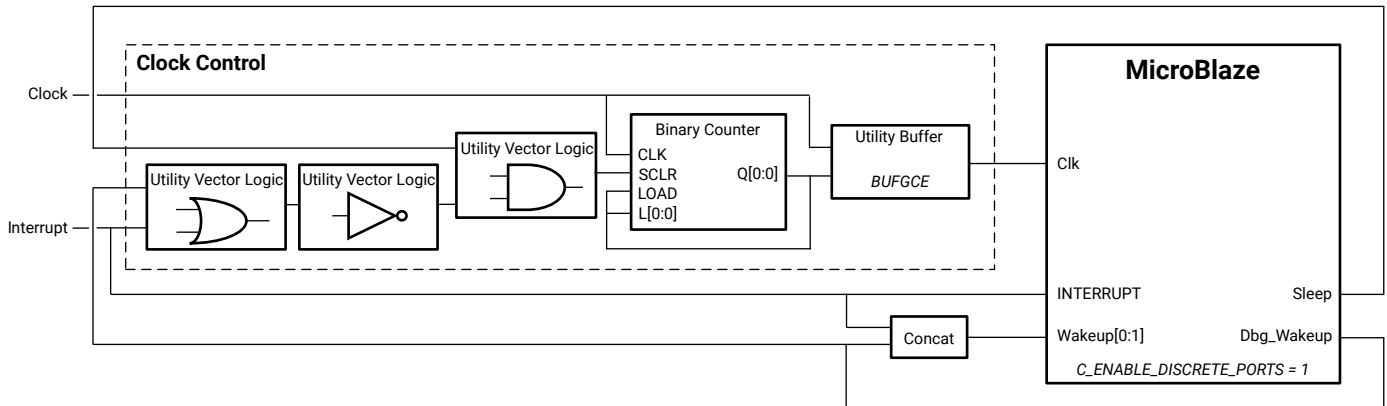

X20274-020818

Instead of implementing the clock control with IP cores, an RTL Module can be used. A possible VHDL implementation corresponding to Clock Control in the block diagram in the preceding figure is given here. See the *Vivado Design Suite User Guide: Designing IP Subsystems Using IP Integrator (UG994)* for more information on RTL Modules.

```

library IEEE;
use IEEE.STD_LOGIC_1164.all;

library UNISIM;
use UNISIM.VComponents.all;

entity clock_control is
    port (
        clkin      : in  std_logic;
        reset      : in  std_logic;
        sleep      : in  std_logic;
        interrupt   : in  std_logic;
        dbg_wakeup : in  std_logic;
        clkout     : out std_logic
    );
end clock_control;

architecture Behavioral of clock_control is
    attribute X_INTERFACE_INFO : string;
    attribute X_INTERFACE_INFO of clkin : signal is ".com:signal:clock:1.0 clk CLK";
    attribute X_INTERFACE_INFO of reset : signal is ".com:signal:reset:1.0 reset RST";
    attribute X_INTERFACE_INFO of interrupt : signal
        is ".com:signal:interrupt:1.0 interrupt INTERRUPT";
    attribute X_INTERFACE_INFO of clkout : signal is ".com:signal:clock:1.0 clk_out CLK";

    attribute X_INTERFACE_PARAMETER : string;
    attribute X_INTERFACE_PARAMETER of reset      : signal is "POLARITY ACTIVE_HIGH";
    attribute X_INTERFACE_PARAMETER of interrupt : signal is "SENSITIVITY LEVEL_HIGH";
    attribute X_INTERFACE_PARAMETER of clkout    : signal is "FREQ_HZ 100000000";

    signal clk_enable : std_logic := '1';
begin
    clock_enable_dff : process (clkin) is
    begin
        if clkin'event and clkin = '1' then
            if reset = '1' then
                clk_enable <= '1';
            elsif sleep = '1' and interrupt = '0' and dbg_wakeup = '0' then
    
```

```
        clk_enable <= '0';
    elsif clk_enable = '0' then
        clk_enable <= '1';
    end if;
end if;
end process clock_enable_dff;

clock_enable : component BUFGCE
    port map (
        O => clkout,
        CE => clk_enable,
        I => clkkin
    );
end Behavioral;
```

Hardware Controlled

When the `Pause` input signal is set to one and MicroBlaze has completed all external accesses, the pipeline is halted and the `Pause_Ack` output signal is set. This indicates to external hardware that it is safe to perform actions such as stopping the clock, resetting the processor or other IP cores. To continue from pause, the input signal `Pause` must be cleared to zero. In this case MicroBlaze continues instruction execution where it was previously paused.

The `Dbg_Continue` output signal from MicroBlaze indicates that the debugger requests the processor to continue from pause. External hardware should handle this signal and clear pause after performing any other necessary hardware actions such as starting the clock.

After external hardware has set or cleared `Pause`, it is recommended to wait until `Pause_Ack` is set or cleared before `Pause` is changed again, to avoid any issues due to incorrectly detected pause acknowledge.

All signals used for hardware control (`Pause`, `Pause_Ack`, and `Dbg_Continue`) are synchronous to the MicroBlaze clock.

The block diagram in the following figure illustrates how to use the pause functionality to halt the processor and how to implement clock control. In this example, `Pause` is an external hardware signal that pauses processor execution and stops the clock. When `Pause` is cleared to zero, the clock is enabled and execution resumes. This example assumes that the external logic monitors `Dbg_Continue`, and clears `Pause` to allow debugging.

Figure 49: Pause Clock Control Block Diagram

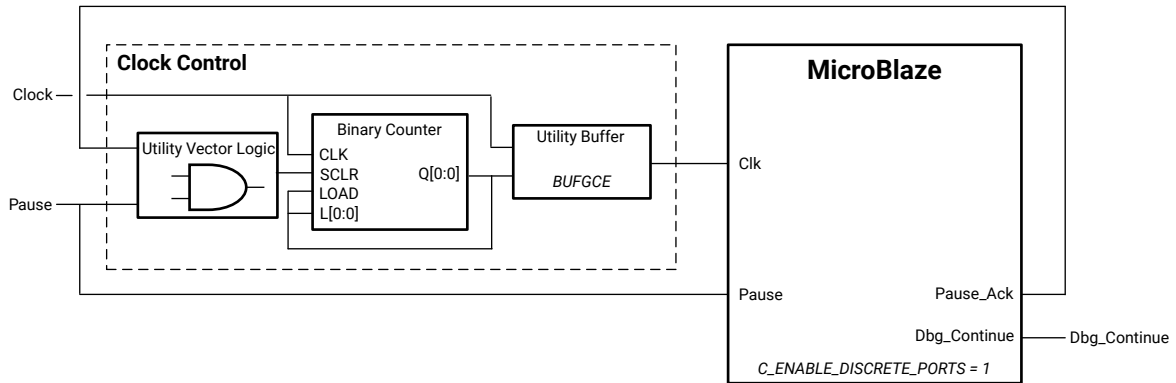

X20276-020818

AXI4 and ACE Interface Description

Memory Mapped Interfaces

Peripheral Interfaces

The MicroBlaze AXI4 peripheral interfaces are implemented as 32-bit or 64-bit masters. Each of these interfaces only have a single outstanding transaction at any time, and all transactions are completed in order.

- The instruction peripheral interface (`M_AXI_IP`) is a 32-bit master, which only performs single word read accesses, and is always set to use the AXI4-Lite subset.
- The data peripheral interface (`M_AXI_DP`) is a 32-bit or 64-bit master, which performs single accesses. It is set to use the AXI4-Lite subset as default, but can be set to use AXI4 when enabling exclusive access for LWX and SWX instructions. Halfword and byte writes are performed by setting the appropriate byte strobes. Each write transaction waits for `M_AXI_DP_BVALID` before the store instruction is completed.

The instruction peripheral interface (`M_AXI_IP`) address width can range from 32 - 64 bits when the MMU physical address extension (PAE) is enabled, depending on the value of the parameter `C_ADDR_SIZE`.

The data peripheral interface (`M_AXI_DP`) address width can range from 32 - 64 bits, depending on the value of the parameter `C_ADDR_SIZE`.

Cache Interfaces

The AXI4 cache interfaces are implemented either as 32-bit, 128-bit, 256-bit, or 512-bit masters, depending on cache line length and data width parameters, whereas the AXI Coherency Extension (ACE) interfaces are implemented as 32-bit masters.

- With a 32-bit master, the instruction cache interface (`M_AXI_IC` or `M_ACE_IC`) performs 4 word, 8 word or 16 word burst read accesses, depending on cache line length. With 128-bit, 256-bit, or 512-bit masters, only single read accesses are performed.

With a 32-bit master, this interface can have multiple outstanding transactions, issuing up to two transactions or up to five transactions when stream cache is enabled. The stream cache can request two cache lines in advance, which means that in some cases five outstanding transactions can occur. In this case the number of outstanding reads is set to 8, because this must be a power of two. With 128-bit, 256-bit, or 512-bit masters, the interface only has a single outstanding transaction.

How memory locations are accessed depend on parameter `C_ICACHE_ALWAYS_USED`. If the parameter is 1, the cached memory range is always accessed using the AXI4 or ACE cache interface. If the parameter is 0, the cached memory range is accessed over the AXI4 peripheral interface when the caches are software disabled (that is, `MSR[ICE]=0`).

- With a 32-bit master, the data cache interface (`M_AXI_DC` or `M_ACE_DC`) performs single word accesses, as well as 4 word, 8 word or 16 word burst accesses, depending on cache line length. Burst write accesses are only performed when using write-back cache with AXI4. With 128-bit, 256-bit, or 512-bit AXI4 masters, only single accesses are performed.

This interface can have multiple outstanding transactions, either issuing up to two transactions when reading, or up to 32 transactions when writing. MicroBlaze ensures that all outstanding writes are completed before a read is issued, because the processor must maintain an ordered memory model but AXI4 or ACE has separate read/write channels without any ordering. Using up to 32 outstanding write transactions improves performance, because it allows multiple writes to proceed without stalling the pipeline.

Word, halfword, and byte writes are performed by setting the appropriate byte strobes.

Exclusive accesses can be enabled for LWX and SWX instructions.

How memory locations are accessed depend on the parameter `C_DCACHE_ALWAYS_USED`. If the parameter is 1, the cached memory range is always accessed using the AXI4 or ACE cache interface. If the parameter is 0, the cached memory range is accessed over the AXI4 peripheral interface when the caches are software disabled (that is, `MSR[DCE]=0`).

Interface Parameters and Signals

The relationship between MicroBlaze parameter settings and AXI4 interface behavior for tool-assigned parameters is summarized in the following table.

Table 70: AXI Memory Mapped Interface Parameters

Interface	Parameter	Description
M_AXI_DP	C_M_AXI_DP_PROTOCOL	AXI4-Lite: Default. AXI4: Used to allow exclusive access when C_M_AXI_DP_EXCLUSIVE_ACCESS is 1.
	C_M_AXI_DP_DATA_WIDTH	32: Default. 64: Can be used with 64-bit MicroBlaze to transfer 64-bit data with a single access.
M_AXI_IC M_ACE_IC	C_M_AXI_IC_DATA_WIDTH	32: Default, single word accesses and burst accesses with C_ICACHE_LINE_LEN word bursts used with AXI4 and ACE. 128: Used when C_ICACHE_DATA_WIDTH is set to 1 and C_ICACHE_LINE_LEN is set to 4 with AXI4. Only single accesses can occur. 256: Used when C_ICACHE_DATA_WIDTH is set to 1 and C_ICACHE_LINE_LEN is set to 8 with AXI4. Only single accesses can occur. 512: Used when C_ICACHE_DATA_WIDTH is set to 2, or when it is set to 1 and C_ICACHE_LINE_LEN is set to 16 with AXI4. Only single accesses can occur.
M_AXI_DC M_ACE_DC	C_M_AXI_DC_DATA_WIDTH	32: Default, single word accesses and burst accesses with C_DCACHE_LINE_LEN word bursts used with AXI4 and ACE. Write bursts are only used with AXI4 when C_DCACHE_USE_WRITEBACK is set to 1. 128: Used when C_DCACHE_DATA_WIDTH is set to 1 and C_DCACHE_LINE_LEN is set to 4 with AXI4. Only single accesses can occur. 256: Used when C_DCACHE_DATA_WIDTH is set to 1 and C_DCACHE_LINE_LEN is set to 8 with AXI4. Only single accesses can occur. 512: Used when C_DCACHE_DATA_WIDTH is set to 2, or when it is set to 1 and C_DCACHE_LINE_LEN is set to 16 with AXI4. Only single accesses can occur.
M_AXI_IC M_ACE_IC	NUM_READ_OUTSTANDING	1: Default for 128-bit, 256-bit and 512-bit masters, a single outstanding read. 2: Default for 32-bit masters, 2 simultaneous outstanding reads. 8: Used for 32-bit masters when C_ICACHE_STREAMS is set to 1, allowing 8 simultaneous outstanding reads. Can be set to 1, 2, or 8.
M_AXI_DC M_ACE_DC	NUM_READ_OUTSTANDING	1: Default for 128-bit, 256-bit and 512-bit masters, a single outstanding read. 2: Default for 32-bit masters, 2 simultaneous outstanding reads. Can be set to 1 or 2.
M_AXI_DC M_ACE_DC	NUM_WRITE_OUTSTANDING	32: Default, 32 simultaneous outstanding writes. Can be set to 1, 2, 4, 8, 16, or 32.

MicroBlaze AXI interfaces do not use any ID, setting `ID_WIDTH` to 0, whereas ACE interfaces use two ID values, setting `ID_WIDTH` to 1.

MicroBlaze will never issue sub-width (narrow) accesses, with size less than the bus width, setting `SUPPORTS_NARROW_BURSTS` to 0 for all interfaces.

Values for access permissions, memory types, quality of service and shareability domain are defined in the following table.

Table 71: AXI Interface Signal Definitions

Interface	Signal	Description
M_AXI_IP	C_M_AXI_IP_ARPROT	Access Permission: <ul style="list-style-type: none"> Unprivileged, secure instruction access (100) if input signal Non_Secure[1] = 0 Unprivileged, non-secure instruction access (110) if input signal Non_Secure[1] = 1
M_AXI_DP	C_M_AXI_DP_ARCACHE C_M_AXI_DP_AWCACHE	Memory Type, AXI4 protocol: <ul style="list-style-type: none"> Normal Non-cacheable Bufferable (0011)
	C_M_AXI_DP_ARPROT C_M_AXI_DP_AWPROT	Access Permission, AXI4 and AXI4-Lite protocol: <ul style="list-style-type: none"> Unprivileged, secure data access (000) if input signal Non_Secure[0] = 0 Unprivileged, non-secure data access (010) if input signal Non_Secure[0] = 1
	C_M_AXI_DP_ARQOS C_M_AXI_DP_AWQOS	Quality of Service, AXI4 protocol: <ul style="list-style-type: none"> Priority 8 (1000)
M_AXI_IC	C_M_AXI_IC_ARCACHE	Memory Type: <ul style="list-style-type: none"> Write-back Read and Write-allocate (1111)
M_ACE_IC	C_M_AXI_IC_ARCACHE	Memory Type, normal access: <ul style="list-style-type: none"> Write-back Read and Write-allocate (1111) Memory Type, DVM access: <ul style="list-style-type: none"> Normal Non-cacheable Non-bufferable (0010)
	C_M_AXI_IC_ARDOMAIN	Shareability Domain: <ul style="list-style-type: none"> Inner shareable (01)
M_AXI_IC M_ACE_IC	C_M_AXI_IC_ARPROT	Access Permission: <ul style="list-style-type: none"> Unprivileged, secure instruction access (100) if input signal Non_Secure[3] = 0 Unprivileged, non-secure instruction access (110) if input signal Non_Secure[3] = 1
	C_M_AXI_IC_ARQOS	Quality of Service: <ul style="list-style-type: none"> Priority 7 (0111)
M_AXI_DC	C_M_AXI_DC_ARCACHE	Memory Type, normal access: <ul style="list-style-type: none"> Write-back Read and Write-allocate (1111) Memory Type, exclusive access: <ul style="list-style-type: none"> Normal Non-cacheable Non-bufferable (0010)
M_ACE_DC	C_M_AXI_DC_ARCACHE	Memory Type, normal and exclusive access: <ul style="list-style-type: none"> Write-back Read and Write-allocate (1111) Memory Type, DVM access: <ul style="list-style-type: none"> Normal Non-cacheable Non-bufferable (0010)
	C_M_AXI_DC_ARDOMAIN C_M_AXI_DC_AWDOMAIN	Shareability Domain: <ul style="list-style-type: none"> Inner shareable (01)

Table 71: AXI Interface Signal Definitions (cont'd)

Interface	Signal	Description
M_AXI_DC M_ACE_DC	C_M_AXI_DC_AWCACHE	Memory Type, normal access: <ul style="list-style-type: none"> Write-back Read and Write-allocate (1111) Memory Type, exclusive access: <ul style="list-style-type: none"> Normal Non-cacheable Non-bufferable (0010)
	C_M_AXI_DC_ARPROT C_M_AXI_DC_AWPROT	Access Permission: <ul style="list-style-type: none"> Unprivileged, secure data access (000) if input signal Non_Secure[2] = 0 Unprivileged, non-secure data access (010) if input signal Non_Secure[2] = 1
	C_M_AXI_DC_ARQOS	Quality of Service, read access: <ul style="list-style-type: none"> Priority 12 ((1100)
	C_M_AXI_DC_AWQOS	Quality of Service, write access: <ul style="list-style-type: none"> Priority 8 (1000)

The instruction cache interface (M_AXI_IC) address width can range from 32 - 64 bits when the MMU physical address extension (PAE) is enabled, depending on the value of the parameter C_ADDR_SIZE.

The data cache interface (M_AXI_DC or M_ACE_DC) address width can range from 32 - 64 bits, depending on the value of the parameter C_ADDR_SIZE.

See the *AMBA AXI and ACE Protocol Specification* ([Arm IHI 0022E](#)) document for details.

Stream Interfaces

The MicroBlaze AXI4-Stream interfaces (M0_AXIS, M15_AXIS, S0_AXIS, S15_AXIS) are implemented as 32-bit masters and slaves. See the *AMBA 4 AXI4-Stream Protocol Specification, Version 1.0* ([Arm IHI 0051A](#)) document for further details.

Write Operation

A write to the stream interface is performed by MicroBlaze using one of the put or putd instructions. A write operation transfers the register contents to an output AXI4 interface. The transfer is completed in a single clock cycle for blocking mode writes (put and cput instructions) as long as the interface is not busy. If the interface is busy, the processor stalls until it becomes available. The non-blocking instructions (with prefix n), always complete in a single clock cycle even if the interface is busy. If the interface was busy, the write is inhibited and the carry bit is set in the MSR.

The control instructions (with prefix c) set the AXI4-Stream TLAST output, to '1', which is used to indicate the boundary of a packet.

Read Operation

A read from the stream interface is performed by MicroBlaze using one of the `get` or `getd` instructions. A read operations transfers the contents of an input AXI4 interface to a general purpose register. The transfer is typically completed in two clock cycles for blocking mode reads as long as data is available. If data is not available, the processor stalls at this instruction until it becomes available. In the non-blocking mode (instructions with prefix `n`), the transfer is completed in one or two clock cycles irrespective of whether or not data was available. In case data was not available, the transfer of data does not take place and the carry bit is set in the MSR.

The data get instructions (without prefix `c`) expect the AXI4-Stream `TLAST` input to be cleared to '0', otherwise the instructions will set `MSR[FSL]` to '1'. Conversely, the control get instructions (with prefix `c`) expect the `TLAST` input to be set to '1', otherwise the instructions will set `MSR[FSL]` to '1'. This can be used to check for the boundary of a packet.

Local Memory Bus (LMB) Interface Description

The LMB is a synchronous bus used primarily to access on-chip block RAM. It uses a minimum number of control signals and a simple protocol to ensure that local block RAM are accessed in a single clock cycle. LMB signals and definitions are shown in the following table. All LMB signals are active-High.

LMB Signal Interface

Table 72: LMB Bus Signals

Signal	Data Interface	Instruction Interface	Type	Description
<code>Addr[0:N-1]</code> ¹	<code>Data_Addr[0:N-1]</code> ¹	<code>Instr_Addr[0:N-1]</code> ²	O	Address bus
<code>Byte_Enable[0:N-1]</code> ³	<code>Byte_Enable[0:N-1]</code> ³	not used	O	Byte enables
<code>Data_Write[0:N-1]</code> ⁴	<code>Data_Write[0:N-1]</code> ⁴	not used	O	Write data bus
<code>AS</code>	<code>D_AS</code>	<code>I_AS</code>	O	Address strobe
<code>Read_Strobe</code>	<code>Read_Strobe</code>	<code>I_Fetch</code>	O	Read in progress
<code>Write_Strobe</code>	<code>Write_Strobe</code>	not used	O	Write in progress
<code>Data_Read[0:N-1]</code> ⁴	<code>Data_Read[0:N-1]</code> ⁴	<code>Instr[0:N-1]</code>	I	Read data bus
<code>Ready</code>	<code>D_Ready</code>	<code>I_Ready</code>	I	Ready for next transfer
<code>Wait</code> ⁵	<code>D_Wait</code>	<code>I_Wait</code>	I	Wait until accepted transfer is ready
<code>CE</code> ⁵	<code>D_CE</code>	<code>I_CE</code>	I	Correctable error

Table 72: LMB Bus Signals (cont'd)

Signal	Data Interface	Instruction Interface	Type	Description
UE ⁵	DUE	IUE	I	Uncorrectable error
Clk	Clk	Clk	I	Bus clock

Notes:

1. N = 32 - 64, set according to C_ADDR_SIZE, added in MicroBlaze v9.6.
2. N = 32 - 64, set according to C_ADDR_SIZE when using PAE or 64-bit MicroBlaze, added in MicroBlaze v10.0.
3. N = 4, 8, set according to C_LMB_DATA_SIZE when using 64-bit MicroBlaze, added in MicroBlaze v11.0.
4. N = 32, 64, set according to C_LMB_DATA_SIZE when using 64-bit MicroBlaze, added in MicroBlaze v11.0.
5. Added in LMB for MicroBlaze v8.00.

Addr[0:N-1]

The address bus is an output from the core and indicates the memory address that is being accessed by the current transfer. It is valid only when AS is High. In multicycle accesses requiring more than one clock cycle to complete), Addr[0:N-1] is valid only in the first clock cycle of the transfer.

Byte_Enable[0:N-1]

The byte enable signals are outputs from the core and indicate which byte lanes of the data bus contain valid data. Byte_Enable is valid only when AS is High. In multicycle accesses requiring more than one clock cycle to complete), Byte_Enable is valid only in the first clock cycle of the transfer. Valid values for Byte_Enable are shown in the following tables.

Table 73: Valid Values for Byte_Enable[0:3]

Byte_Enable[0:3] C_LMB_DATA_WIDTH = 32	Data Byte Lanes Used			
	0:7	8:15	16:23	24:31
0001				•
0010			•	
0100		•		
1000	•			
0011			•	•
1100	•	•		
1111	•	•	•	•

Table 74: Valid Values for Byte_Enable[0:7]

Byte_Enable[0:7] C_LMB_DATA_WIDTH = 64	Data Byte Lanes Used							
	0:7	8:15	16:23	24:31	32:39	40:47	48:55	56:63
00000001								•
00000010							•	
00000100						•		
00001000					•			
00010000				•				
00100000			•					
01000000		•						
10000000	•							
00000011							•	•
00001100					•	•		
00110000			•	•				
11000000	•	•						
00001111					•	•	•	•
11110000	•	•	•	•				
11111111	•	•	•	•	•	•	•	•

Data_Write[0:N-1]

The write data bus is an output from the core and contains the data that is written to memory. It is valid only when AS is high. Only the byte lanes specified by `Byte_Enable[0:3]` contain valid data.

AS

The address strobe is an output from the core and indicates the start of a transfer and qualifies the address bus and the byte enables. It is high only in the first clock cycle of the transfer, after which it goes low and remains low until the start of the next transfer.

Read_Strobe

The read strobe is an output from the core and indicates that a read transfer is in progress. This signal goes high in the first clock cycle of the transfer, and can remain high until the clock cycle after `Ready` is sampled high. If a new read transfer is directly started in the next clock cycle, then `Read_Strobe` remains high.

Write_Strobe

The write strobe is an output from the core and indicates that a write transfer is in progress. This signal goes high in the first clock cycle of the transfer, and can remain high until the clock cycle after Ready is sampled high. If a new write transfer is directly started in the next clock cycle, then `Write_Strobe` remains high.

Data_Read[0:N-1]

The read data bus is an input to the core and contains data read from memory. `Data_Read` is valid on the rising edge of the clock when Ready is high.

Ready

The Ready signal is an input to the core and indicates completion of the current transfer and that the next transfer can begin in the following clock cycle. It is sampled on the rising edge of the clock. For reads, this signal indicates the `Data_Read[0:31]` bus is valid, and for writes it indicates that the `Data_Write[0:31]` bus has been written to local memory.

Wait

The Wait signal is an input to the core and indicates that the current transfer has been accepted, but not yet completed. It is sampled on the rising edge of the clock.

CE

The CE signal is an input to the core and indicates that the current transfer had a correctable error. It is valid on the rising edge of the clock when Ready is high. For reads, this signal indicates that an error has been corrected on the `Data_Read[0:31]` bus, and for byte and halfword writes it indicates that the corresponding data word in local memory has been corrected before writing the new data.

UE

The UE signal is an input to the core and indicates that the current transfer had an uncorrectable error. It is valid on the rising edge of the clock when Ready is high. For reads, this signal indicates that the value of the `Data_Read[0:31]` bus is erroneous, and for byte and halfword writes it indicates that the corresponding data word in local memory was erroneous before writing the new data.

Clk

All operations on the LMB are synchronous to the MicroBlaze core clock.

LMB Transactions

The following diagrams provide examples of LMB bus operations.

Generic Write Operations

Figure 50: LMB Generic Write Operation, 0 Wait States

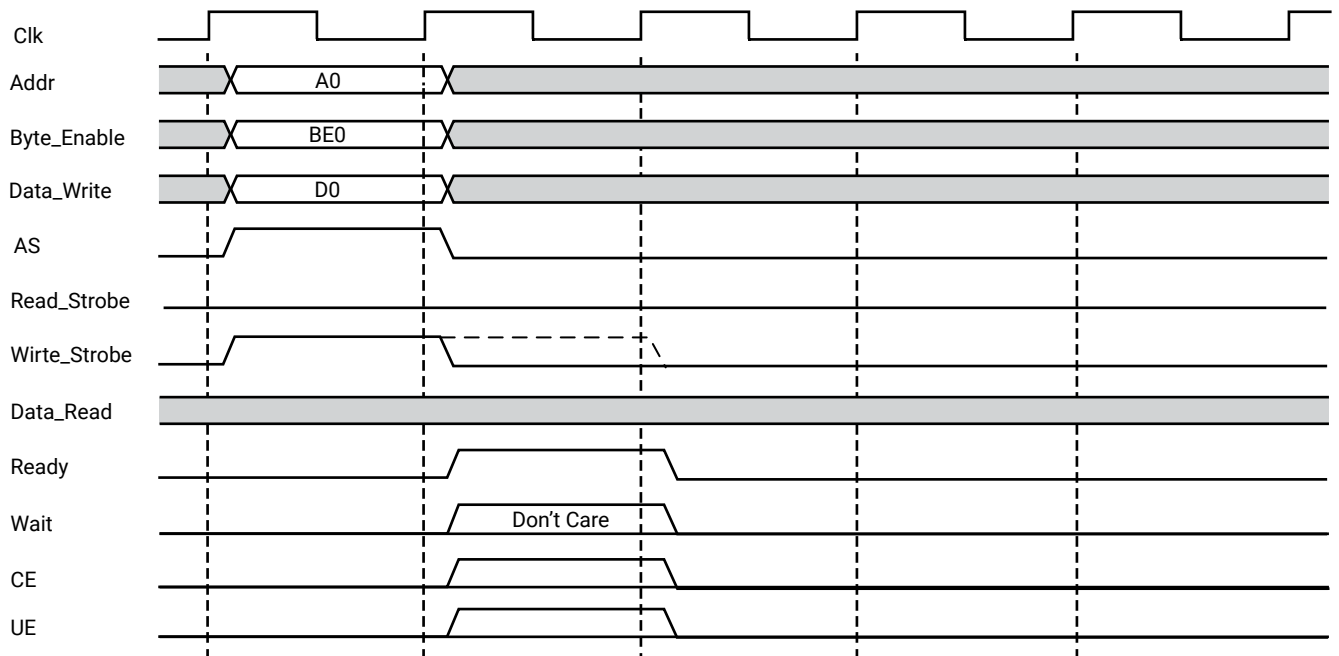

X19788-111717

Figure 51: LMB Generic Write Operation, N Wait States

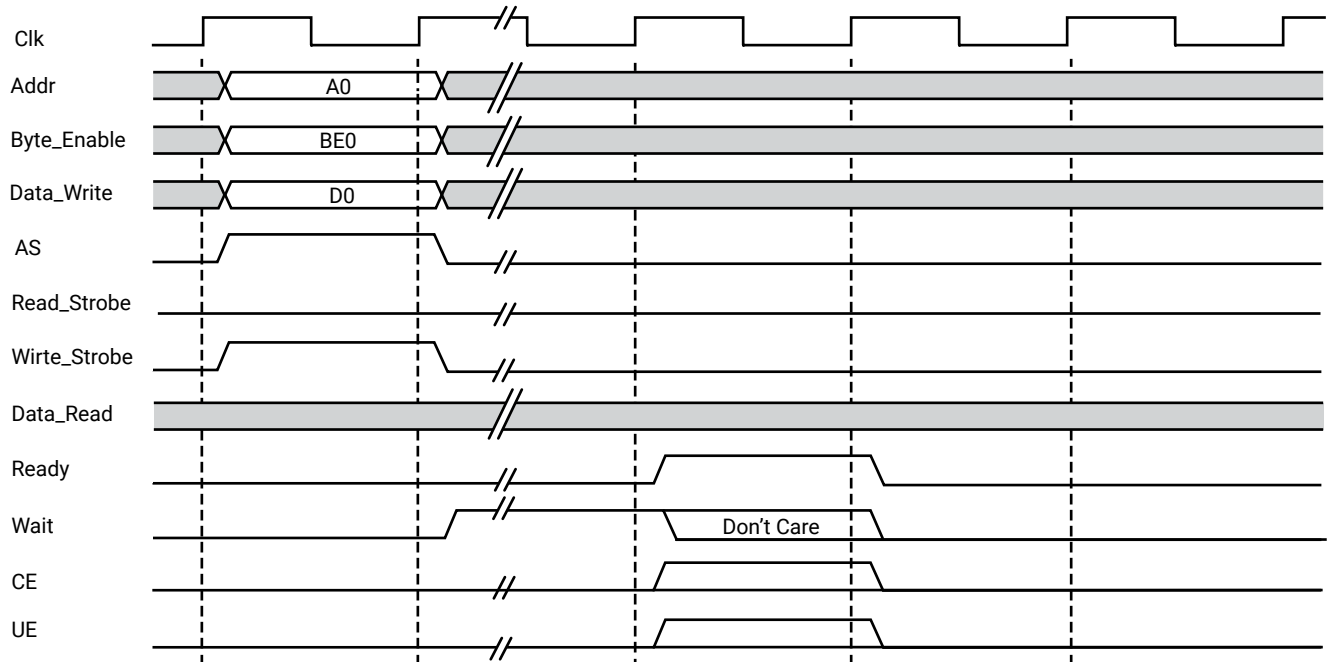

X19789-111717

Generic Read Operations

Figure 52: LMB Generic Read Operation, 0 Wait States

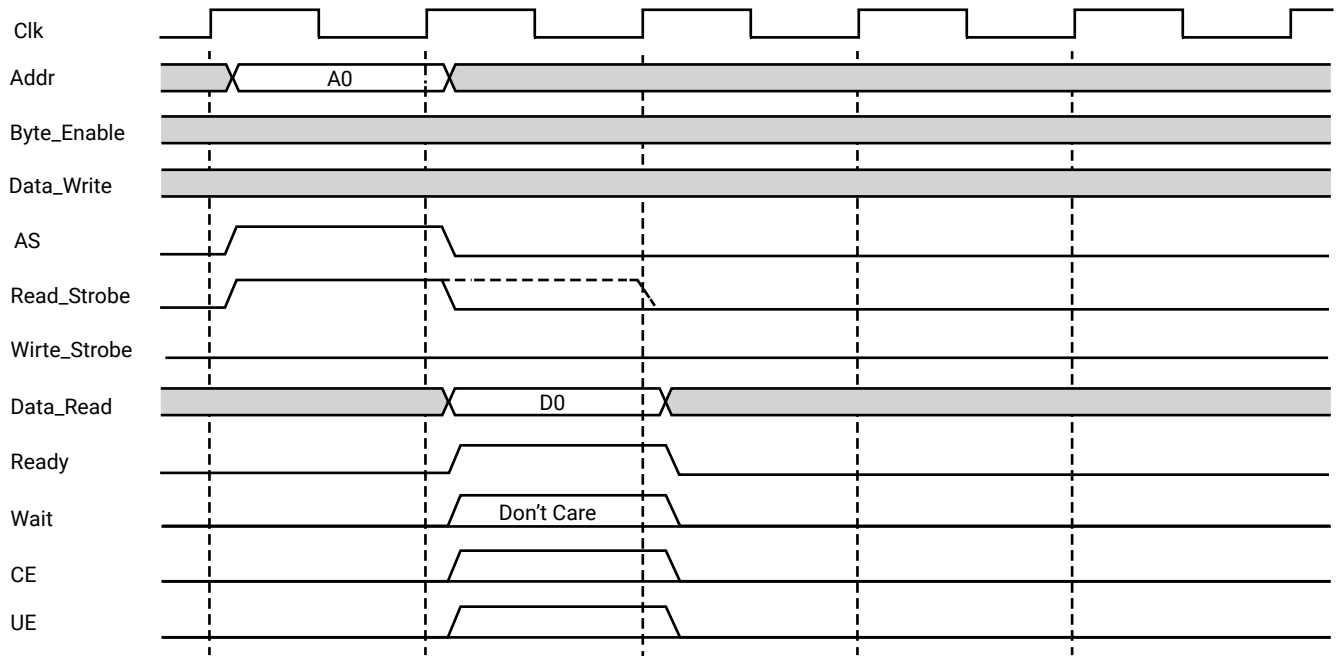

X19790-111717

Figure 53: LMB Generic Read Operation, N Wait States

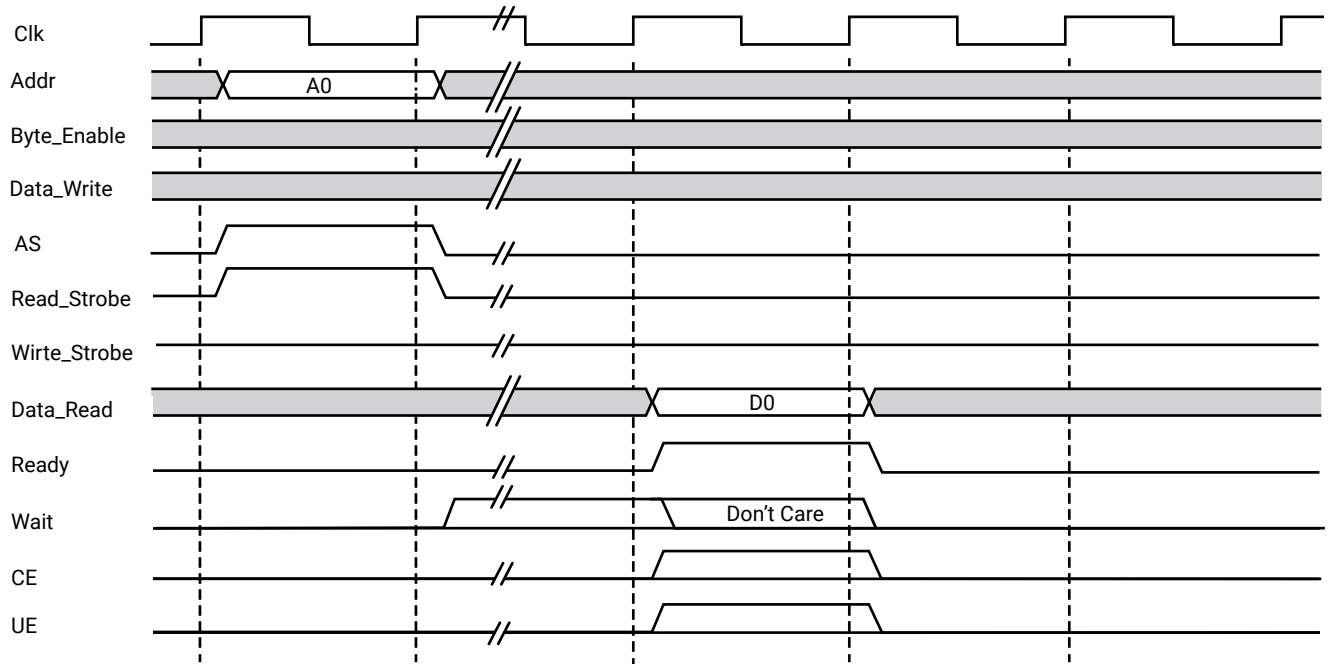

X19791-111717

Back-to-Back Write Operation

Figure 54: LMB Back-to-Back Write Operation

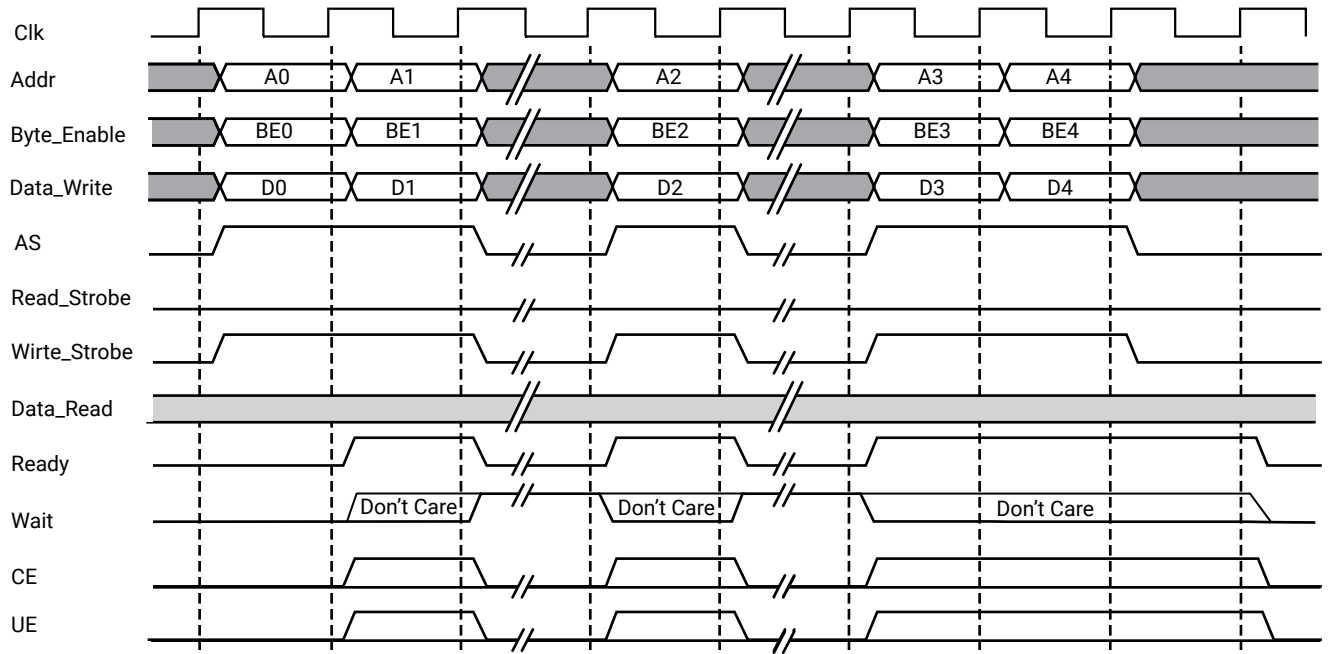

X19792-111717

Back-to-Back Read Operation

Figure 55: LMB Back-to-Back Read Operation

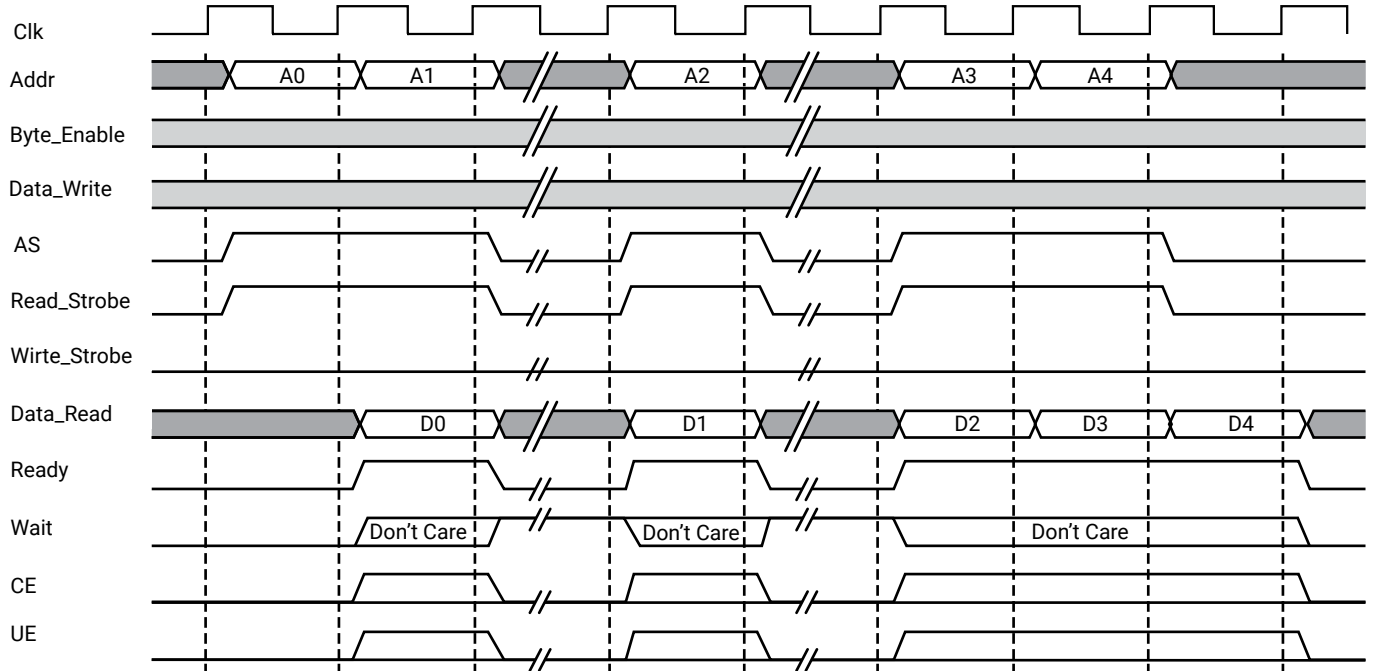

X19793-111717

Back-to-Back Mixed Write/Read Operation

Figure 56: Back-to-Back Mixed Write/Read Operation, 0 Wait States

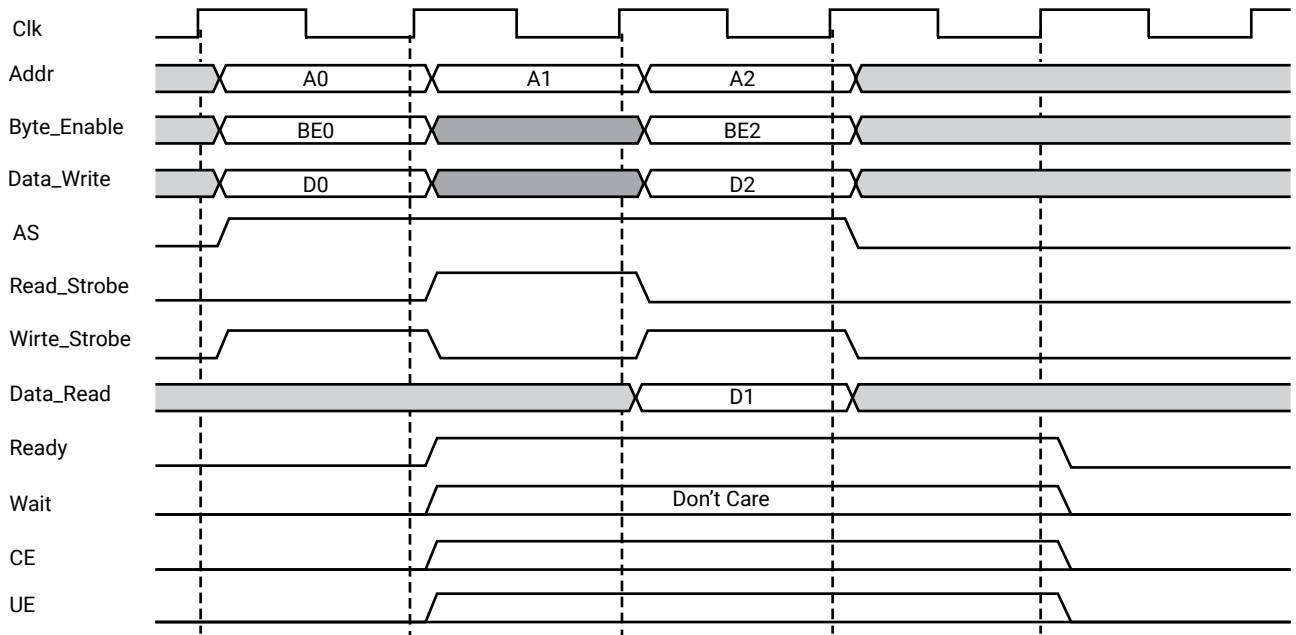

X19794-111717

Figure 57: Back-to-Back Mixed Write/Read Operation, N Wait States

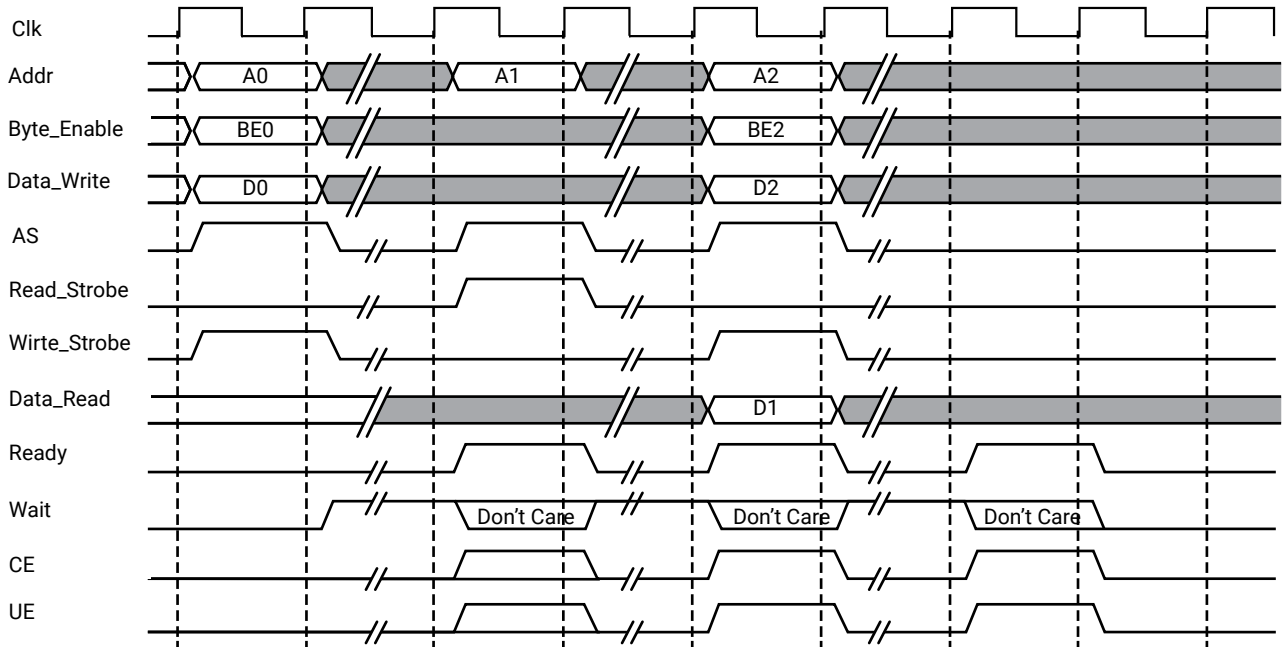

X19795-111717

Read and Write Data Steering

The MicroBlaze data-side bus interface performs the read steering and write steering required to support the following transfers:

- byte, halfword, and word transfers to word devices
- byte and halfword transfers to halfword devices
- byte transfers to byte devices

MicroBlaze does not support transfers that are larger than the addressed device. These types of transfers require dynamic bus sizing and conversion cycles that are not supported by the MicroBlaze bus interface.

Big endian format is only applicable when using the MMU in virtual or protected mode ($C_USE_MMU > 1$) or when reorder instructions are enabled ($C_USE_REORDER_INSTR = 1$).

Data steering with 32-bit data for read cycles are shown in [Table 75: Big Endian Read Data Steering \(Load to Register rD\)](#) and [Table 76: Little Endian Read Data Steering \(Load to Register rD\)](#), and 32-bit data steering for write cycles are shown in [Table 77: Big Endian Write Data Steering \(Store from Register rD\)](#) and [Table 78: Little Endian Write Data Steering \(Store from Register rD\)](#).

Table 75: Big Endian Read Data Steering (Load to Register rD)

Address [LSB-1:LSB]	Byte_Enable [0:3]	Transfer Size	Register rD Data			
			0:7	8:15	16:23	24:31
11	0001	byte				Byte3
10	0010	byte				Byte2
01	0100	byte				Byte1
00	1000	byte				Byte0
10	0011	halfword			Byte2	Byte3
00	1100	halfword			Byte0	Byte1
00	1111	word	Byte0	Byte1	Byte2	Byte3

Table 76: Little Endian Read Data Steering (Load to Register rD)

Address [LSB-1:LSB]	Byte_Enable [0:3]	Transfer Size	Register rD Data			
			0:7	8:15	16:23	24:31
11	1000	byte				Byte0
10	0100	byte				Byte1
01	0010	byte				Byte2
00	0001	byte				Byte3
10	1100	halfword			Byte0	Byte1
00	0011	halfword			Byte2	Byte3
00	1111	word	Byte0	Byte1	Byte2	Byte3

Table 77: Big Endian Write Data Steering (Store from Register rD)

Address [LSB-1:LSB]	Byte_Enable [0:3]	Transfer Size	Write Data Bus Bytes from rD			
			Byte0	Byte1	Byte2	Byte3
11	0001	byte				24:31
10	0010	byte			rD[24:31]	
01	0100	byte		24:31		
00	1000	byte	24:31			
10	0011	halfword			16:23	24:31
00	1100	halfword	16:23	24:31		
00	1111	word	0:7	8:15	16:23	24:31

Table 78: Little Endian Write Data Steering (Store from Register rD)

Address [LSB-1:LSB]	Byte_Enable [0:3]	Transfer Size	Write Data Bus Bytes from rD			
			Byte3	Byte2	Byte1	Byte0
11	1000	byte	24:31			
10	0100	byte		24:31		
01	0010	byte			24:31	
00	0001	byte				24:31
10	1100	halfword	16:23	24:31		
00	0011	halfword			16:23	24:31
00	1111	word	0:7	8:15	16:23	24:31

Note: Other masters could have more restrictive requirements for byte lane placement than those allowed by MicroBlaze. Slave devices are typically attached “left-justified” with byte devices attached to the most-significant byte lane, and halfword devices attached to the most significant halfword lane. The MicroBlaze steering logic fully supports this attachment method.

When using 64-bit data on DLMB or M_AXI_DP with 64-bit MicroBlaze, the following transfers are also supported:

- byte, halfword, word, and long transfers to long devices

Data steering with 64-bit data for read cycles are shown in [Table 79: Big Endian Read Data Steering \(Load to Register rD\)](#) and [Table 80: Little Endian Read Data Steering \(Load to Register rD\)](#), and 64-bit data steering for write cycles are shown in [Table 81: Big Endian Write Data Steering \(Store from Register rD\)](#) and [Table 82: Little Endian Write Data Steering \(Store from Register rD\)](#).

Table 79: Big Endian Read Data Steering (Load to Register rD)

Address [LSB-2:LSB]	Byte_Enable [0:7]	Transfer Size	Register rD Data								
			0:7	8:15	16:23	24:31	32:39	40:47	48:55	56:63	
111	00000001	byte									Byte7
110	00000010	byte									Byte6
101	00000100	byte									Byte5
100	00001000	byte									Byte4
011	00010000	byte									Byte3
010	00100000	byte									Byte2
001	01000000	byte									Byte1
000	10000000	byte									Byte0
110	00000011	halfword								Byte7	Byte6
100	00001100	halfword								Byte5	Byte4
010	00110000	halfword								Byte3	Byte2
000	11000000	halfword								Byte1	Byte0

Table 79: Big Endian Read Data Steering (Load to Register rD) (cont'd)

Address [LSB-2:LSB]	Byte_Enable [0:7]	Transfer Size	Register rD Data							
			0:7	8:15	16:23	24:31	32:39	40:47	48:55	56:63
100	00001111	word					Byte4	Byte5	Byte6	Byte7
000	11110000	word					Byte0	Byte1	Byte2	Byte3
000	11111111	long	Byte0	Byte1	Byte2	Byte3	Byte4	Byte5	Byte6	Byte7

Table 80: Little Endian Read Data Steering (Load to Register rD)

Address [LSB-2:LSB]	Byte_Enable [0:7]	Transfer Size	Register rD Data							
			0:7	8:15	16:23	24:31	32:39	40:47	48:55	56:63
111	10000000	byte								Byte0
110	01000000	byte								Byte1
101	00100000	byte								Byte2
100	00010000	byte								Byte3
011	00001000	byte								Byte4
010	00000100	byte								Byte5
001	00000010	byte								Byte6
000	00000001	byte								Byte7
110	11000000	halfword							Byte0	Byte1
100	00110000	halfword							Byte2	Byte3
010	00001100	halfword							Byte4	Byte5
000	00000011	halfword							Byte6	Byte7
100	11110000	word					Byte0	Byte1	Byte2	Byte3
000	00001111	word					Byte4	Byte5	Byte6	Byte7
000	11111111	long	Byte0	Byte1	Byte2	Byte3	Byte4	Byte5	Byte6	Byte7

Table 81: Big Endian Write Data Steering (Store from Register rD)

Address [LSB-2:LSB]	Byte_Enable [0:7]	Transfer Size	Write Data Bus Bytes from rD							
			Byte0	Byte1	Byte2	Byte3	Byte4	Byte5	Byte6	Byte7
111	00000001	byte								56:63
110	00000010	byte								56:63
101	00000100	byte						56:63		
100	00001000	byte					56:63			
011	00010000	byte				56:63				
010	00100000	byte			56:63					
001	01000000	byte		56:63						
000	10000000	byte	56:63							
110	00000011	halfword							48:55	56:63
100	00001100	halfword					48:55	56:63		

Table 81: Big Endian Write Data Steering (Store from Register rD) (cont'd)

Address [LSB-2:LSB]	Byte_Enable [0:7]	Transfer Size	Write Data Bus Bytes from rD							
			Byte0	Byte1	Byte2	Byte3	Byte4	Byte5	Byte6	Byte7
010	00110000	halfword			48:55	56:63				
000	11000000	halfword	48:55	56:63						
100	00001111	word					32:39	40:47	48:55	56:63
000	11110000	word	32:39	40:47	48:55	56:63				
000	11111111	long	0:7	8:15	16:23	24:31	32:39	40:47	48:55	56:63

Table 82: Little Endian Write Data Steering (Store from Register rD)

Address [LSB-2:LSB]	Byte_Enable [0:7]	Transfer Size	Write Data Bus Bytes from rD							
			Byte7	Byte6	Byte5	Byte4	Byte3	Byte2	Byte1	Byte0
111	10000000	byte	56:63							
110	01000000	byte		56:63						
101	00100000	byte			56:63					
100	00010000	byte				56:63				
011	00001000	byte					56:63			
010	00000100	byte						56:63		
001	00000010	byte							56:63	
000	00000000	byte								56:63
110	11000000	halfword	48:55	56:63						
100	00110000	halfword			48:55	56:63				
010	00001100	halfword					48:55	56:63		
000	00000011	halfword							48:55	56:63
100	11110000	word	32:39	40:47	48:55	56:63				
000	00001111	word					32:39	40:47	48:55	56:63
000	11111111	long	0:7	8:15	16:23	24:31	32:39	40:47	48:55	56:63

Lockstep Interface Description

The lockstep interface on MicroBlaze is designed to connect a master and one or more slave MicroBlaze instances. The lockstep signals on MicroBlaze are listed in the following table.

Table 83: MicroBlaze Lockstep Signals

Signal Name	Description	VHDL Type	Direction
Lockstep_Master_Out	Output with signals going from master to slave MicroBlaze. Not connected on slaves.	std_logic	output

Table 83: MicroBlaze Lockstep Signals (cont'd)

Signal Name	Description	VHDL Type	Direction
Lockstep_Slave_In	Input with signals coming from master to slave MicroBlaze. Not connected on master.	std_logic	input
Lockstep_Out	Output with all comparison signals from both master and slaves.	std_logic	output

The comparison signals provided by `Lockstep_Out` are listed in the following table.

Table 84: MicroBlaze Lockstep Comparison Signals

Signal Name	Bus Index Range	VHDL Type
MB_Halted	0	std_logic
MB_Error	1	std_logic
IFetch	2	std_logic
I_AS	3	std_logic
Instr_Addr	4 to 67	std_logic_vector
Data_Addr	68 to 131	std_logic_vector
Data_Write	132 to 163	std_logic_vector
D_AS	196	std_logic
Read_Strobe	197	std_logic
Write_Strobe	198	std_logic
Byte_Enable	199 to 202	std_logic_vector
M_AXI_IP_AWID	207	std_logic
M_AXI_IP_AWADDR	208 to 271	std_logic_vector
M_AXI_IP_AWLEN	272 to 279	std_logic_vector
M_AXI_IP_AWSIZE	280 to 282	std_logic_vector
M_AXI_IP_AWBURST	283 to 284	std_logic_vector
M_AXI_IP_AWLOCK	285	std_logic
M_AXI_IP_AWCACHE	286 to 289	std_logic_vector
M_AXI_IP_AWPROT	290 to 292	std_logic_vector
M_AXI_IP_AWQOS	293 to 296	std_logic_vector
M_AXI_IP_AWVALID	297	std_logic
M_AXI_IP_WDATA	298 to 329	std_logic_vector
M_AXI_IP_WSTRB	362 to 365	std_logic_vector
M_AXI_IP_WLAST	370	std_logic
M_AXI_IP_WVALID	371	std_logic
M_AXI_IP_BREADY	372	std_logic
M_AXI_IP_ARID	373	std_logic
M_AXI_IP_ARADDR	374 to 437	std_logic_vector
M_AXI_IP_ARLEN	438 to 445	std_logic_vector

Table 84: MicroBlaze Lockstep Comparison Signals (cont'd)

Signal Name	Bus Index Range	VHDL Type
M_AXI_IP_ARSIZE	446 to 448	std_logic_vector
M_AXI_IP_ARBURST	449 to 450	std_logic_vector
M_AXI_IP_ARLOCK	451	std_logic
M_AXI_IP_ARCACHE	452 to 455	std_logic_vector
M_AXI_IP_ARPROT	456 to 458	std_logic_vector
M_AXI_IP_ARQOS	459 to 462	std_logic_vector
M_AXI_IP_ARVALID	463	std_logic
M_AXI_IP_RREADY	464	std_logic
M_AXI_DP_AWID	465	std_logic
M_AXI_DP_AWADDR	466 to 529	std_logic_vector
M_AXI_DP_AWLEN	530 to 537	std_logic_vector
M_AXI_DP_AWSIZE	538 to 540	std_logic_vector
M_AXI_DP_AWBURST	541 to 542	std_logic_vector
M_AXI_DP_AWLOCK	543	std_logic
M_AXI_DP_AWCACHE	544 to 547	std_logic_vector
M_AXI_DP_AWPROT	548 to 550	std_logic_vector
M_AXI_DP_AWQOS	551 to 554	std_logic_vector
M_AXI_DP_AWVALID	555	std_logic
M_AXI_DP_WDATA	556 to 619	std_logic_vector
M_AXI_DP_WSTRB	620 to 627	std_logic_vector
M_AXI_DP_WLAST	628	std_logic
M_AXI_DP_WVALID	629	std_logic
M_AXI_DP_BREADY	630	std_logic
M_AXI_DP_ARID	631	std_logic
M_AXI_DP_ARADDR	632 to 695	std_logic_vector
M_AXI_DP_ARLEN	696 to 703	std_logic_vector
M_AXI_DP_ARSIZE	704 to 706	std_logic_vector
M_AXI_DP_ARBURST	707 to 708	std_logic_vector
M_AXI_DP_ARLOCK	709	std_logic
M_AXI_DP_ARCACHE	710 to 713	std_logic_vector
M_AXI_DP_ARPROT	714 to 716	std_logic_vector
M_AXI_DP_ARQOS	717 to 720	std_logic_vector
M_AXI_DP_ARVALID	721	std_logic
M_AXI_DP_RREADY	722	std_logic
Mn_AXIS_TLAST	$723 + n * 35$	std_logic
Mn_AXIS_TDATA	$758 + n * 35$ to $789 + n * 35$	std_logic_vector
Mn_AXIS_TVALID	$790 + n * 35$	std_logic
Sn_AXIS_TREADY	$791 + n * 35$	std_logic

Table 84: MicroBlaze Lockstep Comparison Signals (cont'd)

Signal Name	Bus Index Range	VHDL Type
M_AXI_IC_AWID	1283	std_logic
M_AXI_IC_AWADDR	1284 to 1347	std_logic_vector
M_AXI_IC_AWLEN	1348 to 1355	std_logic_vector
M_AXI_IC_AWSIZE	1356 to 1358	std_logic_vector
M_AXI_IC_AWBURST	1359 to 1360	std_logic_vector
M_AXI_IC_AWLOCK	1361	std_logic
M_AXI_IC_AWCACHE	1362 to 1365	std_logic_vector
M_AXI_IC_AWPROT	1366 to 1368	std_logic_vector
M_AXI_IC_AWQOS	1369 to 1372	std_logic_vector
M_AXI_IC_AWVALID	1373	std_logic
M_AXI_IC_AWUSER	1374 to 1378	std_logic_vector
M_AXI_IC_AWDOMAIN ¹	1379 to 1380	std_logic_vector
M_AXI_IC_AWSNOOP ¹	1381 to 1383	std_logic_vector
M_AXI_IC_AWBAR ¹	1384 to 1385	std_logic_vector
M_AXI_IC_WDATA	1386 to 1897	std_logic_vector
M_AXI_IC_WSTRB	1898 to 1961	std_logic_vector
M_AXI_IC_WLAST	1962	std_logic
M_AXI_IC_WVALID	1963	std_logic
M_AXI_IC_WUSER	1964	std_logic
M_AXI_IC_BREADY	1965	std_logic
M_AXI_IC_WACK	1966	std_logic
M_AXI_IC_ARID	1967	std_logic_vector
M_AXI_IC_ARADDR	1968 to 2031	std_logic_vector
M_AXI_IC_ARLEN	2032 to 2039	std_logic_vector
M_AXI_IC_ARSIZE	2040 to 2042	std_logic_vector
M_AXI_IC_ARBURST	2043 to 2044	std_logic_vector
M_AXI_IC_ARLOCK	2045	std_logic
M_AXI_IC_ARCACHE	2046 to 2049	std_logic_vector
M_AXI_IC_ARPROT	2050 to 2052	std_logic_vector
M_AXI_IC_ARQOS	2053 to 2056	std_logic_vector
M_AXI_IC_ARVALID	2057	std_logic
M_AXI_IC_ARUSER	2058 to 2062	std_logic_vector
M_AXI_IC_ARDOMAIN ¹	2063 to 2064	std_logic_vector
M_AXI_IC_ARSNOOP ¹	2065 to 2068	std_logic_vector
M_AXI_IC_ARBAR ¹	2069 to 2070	std_logic_vector
M_AXI_IC_RREADY	2071	std_logic
M_AXI_IC_RACK ¹	2072	std_logic
M_AXI_IC_ACREADY ¹	2073	std_logic
M_AXI_IC_CRVALID ¹	2074	std_logic

Table 84: MicroBlaze Lockstep Comparison Signals (cont'd)

Signal Name	Bus Index Range	VHDL Type
M_AXI_IC_CRRESP ¹	2075 to 2079	std_logic_vector
M_AXI_IC_CDVALID ¹	2080	std_logic
M_AXI_IC_CDLAST ¹	2081	std_logic
M_AXI_DC_AWID	2082	std_logic
M_AXI_DC_AWADDR	2083 to 2146	std_logic_vector
M_AXI_DC_AWLEN	2147 to 2154	std_logic_vector
M_AXI_DC_AWSIZE	2155 to 2157	std_logic_vector
M_AXI_DC_AWBURST	2158 to 2159	std_logic_vector
M_AXI_DC_AWLOCK	2160	std_logic
M_AXI_DC_AWCACHE	2161 to 2164	std_logic_vector
M_AXI_DC_AWPROT	2165 to 2167	std_logic_vector
M_AXI_DC_AWQOS	2168 to 2171	std_logic_vector
M_AXI_DC_AWVALID	2172	std_logic
M_AXI_DC_AWUSER	2172 to 2176	std_logic_vector
M_AXI_DC_AWDOMAIN ¹	2177 to 2178	std_logic_vector
M_AXI_DC_AWSNOOP ¹	2179 to 2182	std_logic_vector
M_AXI_DC_AWBAR ¹	2183 to 2184	std_logic_vector
M_AXI_DC_WDATA	2185 to 2696	std_logic_vector
M_AXI_DC_WSTRB	2697 to 2760	std_logic_vector
M_AXI_DC_WLAST	2761	std_logic
M_AXI_DC_WVALID	2762	std_logic
M_AXI_DC_WUSER	2863	std_logic
M_AXI_DC_BREADY	2764	std_logic
M_AXI_DC_WACK ¹	2765	std_logic
M_AXI_DC_ARID	2766	std_logic
M_AXI_DC_ARADDR	2767 to 2830	std_logic_vector
M_AXI_DC_ARLEN	2831 to 2838	std_logic_vector
M_AXI_DC_ARSIZE	2839 to 2841	std_logic_vector
M_AXI_DC_ARBURST	2842 to 2843	std_logic_vector
M_AXI_DC_ARLOCK	2844	std_logic
M_AXI_DC_ARCACHE	2845 to 2848	std_logic_vector
M_AXI_DC_ARPROT	2849 to 2851	std_logic_vector
M_AXI_DC_ARQOS	2852 to 2855	std_logic_vector
M_AXI_DC_ARVALID	2856	std_logic
M_AXI_DC_ARUSER	2857 to 2861	std_logic_vector
M_AXI_DC_ARDOMAIN ¹	2862 to 2863	std_logic_vector
M_AXI_DC_ARSNOOP ¹	2864 to 2867	std_logic_vector
M_AXI_DC_ARBAR ¹	2868 to 2869	std_logic_vector
M_AXI_DC_RREADY	2870	std_logic

Table 84: MicroBlaze Lockstep Comparison Signals (cont'd)

Signal Name	Bus Index Range	VHDL Type
M_AXI_DC_RACK ¹	2871	std_logic
M_AXI_DC_ACREADY ¹	2872	std_logic
M_AXI_DC_CRVALID ¹	2873	std_logic
M_AXI_DC_CRRESP ¹	2874 to 2878	std_logic_vector
M_AXI_DC_CDVALID ¹	2879	std_logic
M_AXI_DC_CDLAST ¹	2880	std_logic
Trace_Instruction	2881 to 2912	std_logic_vector
Trace_Valid_Instr	2913	std_logic
Trace_PC	2914 to 2945	std_logic_vector
Trace_Reg_Write	2978	std_logic
Trace_Reg_Addr	2979 to 2983	std_logic_vector
Trace_MSR_Reg	2984 to 2998	std_logic_vector
Trace_PID_Reg	2999 to 3006	std_logic_vector
Trace_New_Reg_Value	3007 to 3038	std_logic_vector
Trace_Exception_Taken	3071	std_logic
Trace_Exception_Kind	3072 to 3076	std_logic_vector
Trace_Jump_Taken	3077	std_logic
Trace_Delay_Slot	3078	std_logic
Trace_Data_Address	3079 to 3142	std_logic_vector
Trace_Data_Write_Value	3143 to 3174	std_logic_vector
Trace_Data_Byte_Enable	3207 to 3210	std_logic_vector
Trace_Data_Access	3215	std_logic
Trace_Data_Read	3216	std_logic
Trace_Data_Write	3217	std_logic
Trace_DCache_Req	3218	std_logic
Trace_DCache_Hit	3219	std_logic
Trace_DCache_Rdy	3220	std_logic
Trace_DCache_Read	3221	std_logic
Trace_ICache_Req	3222	std_logic
Trace_ICache_Hit	3223	std_logic
Trace_ICache_Rdy	3224	std_logic
Trace_OF_PipeRun	3225	std_logic
Trace_EX_PipeRun	3226	std_logic
Trace_MEM_PipeRun	3227	std_logic
Trace_MB_Halted	3228	std_logic
Trace_Jump_Hit	3229	std_logic
Reserved	3230 to 4095	

Notes:

1. This signal is only used when C_INTERCONNECT = 3 (ACE).

Debug Interface Description

The debug interface on MicroBlaze is designed to work with the MicroBlaze Debug Module (MDM) IP core. The MDM is controlled by the Xilinx System Debugger (XSDB) through the JTAG port of the FPGA. The MDM can control multiple MicroBlaze processors at the same time. The debug signals are grouped in the DEBUG bus.

The debug interface can be grouped in the DEBUG bus, using either JTAG serial signals (by setting `C_DEBUG_INTERFACE = 0`) or the AXI4-Lite compatible parallel signals (by setting `C_DEBUG_INTERFACE = 1`). The MDM configuration must also be set accordingly.

It is also possible to use only AXI4-Lite parallel signals (`C_DEBUG_INTERFACE = 2`) grouped in an AXI4 bus, in case the MDM is not used. However, this configuration is not supported by the tools.

The following table lists the debug signals on MicroBlaze.

Table 85: MicroBlaze Debug Signals

Signal Name	Description	VHDL Type	Kind
Dbg_Clk	JTAG clock from MDM	std_logic	serial in
Dbg_TDI	JTAG TDI from MDM	std_logic	serial in
Dbg_TDO	JTAG TDO to MDM	std_logic	serial out
Dbg_Reg_En	Debug register enable from MDM	std_logic_vector	serial in
Dbg_Shift ¹	JTAG BSCAN shift signal from MDM	std_logic	serial in
Dbg_Capture	JTAG BSCAN capture signal from MDM	std_logic	serial in
Dbg_Update	JTAG BSCAN update signal from MDM	std_logic	serial in
Debug_Rst ¹	Reset signal from MDM, active-High. Should be held for at least 1 Clk clock cycle.	std_logic	input
Dbg_Disable ²	Debug disable signal from MDM	std_logic	input
Dbg_Trig_In ²	Cross trigger event input to MDM	std_logic_vector	output
Dbg_Trig_Ack_In ²	Cross trigger event input acknowledge from MDM	std_logic_vector	input
Dbg_Trig_Out ²	Cross trigger action output from MDM	std_logic_vector	input
Dbg_Trig_Ack_Out ²	Cross trigger action output acknowledge to MDM	std_logic_vector	output
Dbg_Trace_Data ³	External Program Trace data output to MDM	std_logic_vector	output
Dbg_Trace_Valid ³	External Program Trace valid to MDM	std_logic	output
Dbg_Trace_Ready ³	External Program Trace ready from MDM	std_logic	input
Dbg_Trace_Clk ³	External Program Trace clock from MDM	std_logic	input
Dbg_ARADDR ⁴	Read address from MDM	std_logic_vector	parallel in
Dbg_ARREADY ⁴	Read address ready to MDM	std_logic	parallel out
Dbg_ARVALID ⁴	Read address valid from MDM	std_logic	parallel in
Dbg_AWADDR ⁴	Write address from MDM	std_logic_vector	parallel in

Table 85: MicroBlaze Debug Signals (cont'd)

Signal Name	Description	VHDL Type	Kind
Dbg_AWREADY ⁴	Write address ready to MDM	std_logic	parallel out
Dbg_AWVALID ⁴	Write address valid from MDM	std_logic	parallel in
Dbg_BREADY ⁴	Write response ready to MDM	std_logic	parallel out
Dbg_BRESP ⁴	Write response to MDM	std_logic_vector	parallel out
Dbg_BVALID ⁴	Write response valid from MDM	std_logic	parallel in
Dbg_RDATA ⁴	Read data to MDM	std_logic_vector	parallel out
Dbg_RREADY ⁴	Read data ready to MDM	std_logic	parallel out
Dbg_RRESP ⁴	Read data response to MDM	std_logic_vector	parallel out
Dbg_RVALID ⁴	Read data valid from MDM	std_logic	parallel in
Dbg_WDATA ⁴	Write data from MDM	std_logic_vector	parallel in
Dbg_WREADY ⁴	Write data ready to MDM	std_logic	parallel out
Dbg_WVALID ⁴	Write data valid from MDM	std_logic	parallel in
DEBUG_ACLK ⁴	Debug clock, must be same as Clk	std_logic	parallel in
DEBUG_ARESET ⁴	Debug reset, must be same as Reset	std_logic	parallel in

Notes:

1. Updated for MicroBlaze v7.00: Dbg_Shift added and Debug_Rst included in DEBUG bus
2. Updated for MicroBlaze v9.3: Dbg_Disable and Dbg_Trig signals added to DEBUG bus
3. Updated for MicroBlaze v9.4: External Program Trace signal added to DEBUG bus
4. Updated for MicroBlaze v10.0: Parallel debug signals added to DEBUG bus

Trace Interface Description

The MicroBlaze processor core exports a number of internal signals for trace purposes. This signal interface is not standardized and new revisions of the processor might not be backward compatible for signal selection or functionality. It is recommended that you not design custom logic for these signals, but rather to use them using AMD provided analysis IP. The trace signals are grouped in the TRACE bus. The current set of trace signals were last updated for MicroBlaze v7.30 and are listed in [Table 86: MicroBlaze Trace Signals](#).

The mapping of the MSR bits is shown in [Table 87: Mapping of Trace MSR](#). For a complete description of the Machine Status Register, see [Special Purpose Registers](#).

The Trace exception types are listed in [Table 88: Type of Trace Exception](#). All unused Trace exception types are reserved.

Table 86: MicroBlaze Trace Signals

Signal Name	Description	VHDL Type	Direction
Trace_Valid_Instr	Valid instruction on trace port.	std_logic	output

Table 86: MicroBlaze Trace Signals (cont'd)

Signal Name	Description	VHDL Type	Direction
Trace_Instruction ¹	Instruction code	std_logic_vector (0 to 31)	output
Trace_PC ¹	Program counter, where N = 32 - 64, determined by parameter C_ADDR_SIZE for 64-bit MicroBlaze, and 32 otherwise	std_logic_vector (0 to 31)	output
Trace_Reg_Write ¹	Instruction writes to the register file	std_logic	output
Trace_Reg_Addr ¹	Destination register address	std_logic_vector (0 to 4)	output
Trace_MSR_Reg ¹	Machine status register. The mapping of the register bits is documented below.	std_logic_vector (0 to 14) ¹	output
Trace_PID_Reg ¹	Process identifier register	std_logic_vector (0 to 7)	output
Trace_New_Reg_Value ¹	Destination register update value, where N = C_DATA_SIZE	std_logic_vector (0 to N-1)	output
Trace_Exception_Taken ^{1,2}	Instruction result in taken exception	std_logic	output
Trace_Exception_Kind ¹	Exception type. The description for the exception type is documented below.	std_logic_vector (0 to 4) ²	output
Trace_Jump_Taken ¹	Branch instruction evaluated true, that is taken	std_logic	output
Trace_Jump_Hit ^{1,3}	Branch Target Cache hit	std_logic	output
Trace_Delay_Slot ¹	Instruction is in delay slot of a taken branch	std_logic	output
Trace_Data_Access ¹	Valid D-side memory access	std_logic	output
Trace_Data_Address ¹	Address for D-side memory access, where N = 32 - 64, determined by parameter C_ADDR_SIZE	std_logic_vector (0 to N-1)	output
Trace_Data_Write_Value ¹	Value for D-side memory write access, where N = C_DATA_SIZE	std_logic_vector (0 to N-1)	output
Trace_Data_Byte_Enable ¹	Byte enables for D-side memory access, where N = C_DATA_SIZE / 8	std_logic_vector (0 to N-1)	output
Trace_Data_Read ¹	D-side memory access is a read	std_logic	output
Trace_Data_Write ¹	D-side memory access is a write	std_logic	output
Trace_DCache_Req	Data memory address is within D-Cache range. Set when a memory access instruction is executed.	std_logic	output
Trace_DCache_Hit	Data memory address is present in D-Cache. Set simultaneously with Trace_DCache_Req when a cache hit occurs.	std_logic	output
Trace_DCache_Rdy	Data memory address is within D-Cache range and the access is completed. Only set following a request with Trace_DCache_Req = 1 and Trace_DCache_Hit = 0.	std_logic	output
Trace_DCache_Read	The D-Cache request is a read. Valid only when Trace_DCache_Req = 1.	std_logic	output

Table 86: MicroBlaze Trace Signals (cont'd)

Signal Name	Description	VHDL Type	Direction
Trace_ICache_Req	Instruction memory address is within I-Cache range, and the cache is enabled in the Machine Status Register. Set when an instruction is read into the instruction prefetch buffer.	std_logic	output
Trace_ICache_Hit	Instruction memory address is present in I-Cache. Set simultaneously with Trace_ICache_Req when a cache hit occurs.	std_logic	output
Trace_ICache_Rdy	<ul style="list-style-type: none"> Instruction memory address is present in I-Cache. Set simultaneously with Trace_ICache_Req when a cache hit occurs in this case. Instruction memory address is within I-Cache range and the access is completed. Set following a request with Trace_ICache_Req = 1 and Trace_ICache_Hit = 0 in this case. 	std_logic	output
Trace_OF_PipeRun	Pipeline advance for Decode stage	std_logic	output
Trace_EX_PipeRun ³	Pipeline advance for Execution stage	std_logic	output
Trace_MEM_PipeRun ³	Pipeline advance for Memory stage	std_logic	output
Trace_MB_Halted	Pipeline is halted by debug	std_logic	output

Notes:

1. Valid only when Trace_Valid_Instr = 1
2. Valid only when Trace_Exception_Taken = 1
3. Not used with area optimization feature

Table 87: Mapping of Trace MSR

Trace_MSR_Reg	Machine Status Register		
	Bit ¹	Name	Description
0	17 or 49	VMS	Virtual Protected Mode Save
1	18 or 50	VM	Virtual Protected Mode
2	19 or 51	UMS	User Mode Save
3	20 or 52	UM	User Mode
4	21 or 53	PVR	Processor Version Register exists
5	22 or 54	EIP	Exception In Progress
6	23 or 55	EE	Exception Enable
7	24 or 56	DCE	Data Cache Enable
8	25 or 57	DZO	Division by Zero or Division Overflow

Table 87: Mapping of Trace MSR (cont'd)

Trace_MSR_Reg	Machine Status Register		
Bit	Bit ¹	Name	Description
9	26 or 58	ICE	Instruction Cache Enable
10	27 or 59	FSL	AXI4-Stream Error
11	28 or 60	BIP	Break in Progress
12	29 or 61	C	Arithmetic Carry
13	30 or 62	IE	Interrupt Enable
14	31 or 63	Reserved	Reserved

Notes:

1. Bit numbers depend on if 64-bit MicroBlaze (C_DATA_SIZE = 64) is enabled or not.

Table 88: Type of Trace Exception

Trace_Exception_Kind [0:4]	Description
00000	Stream exception
00001	Unaligned exception
00010	Illegal Opcode exception
00011	Instruction Bus exception
00100	Data Bus exception
00101	Divide exception
00110	FPU exception
00111	Privileged instruction exception
01010	Interrupt
01011	External non maskable break
01100	External maskable break
10000	Data storage exception
10001	Instruction storage exception
10010	Data TLB miss exception
10011	Instruction TLB miss exception

MicroBlaze Core Configurability

The MicroBlaze core has been developed to support a high degree of user configurability. This allows tailoring of the processor to meet specific cost/performance requirements.

Configuration is done using parameters that typically enable, size, or select certain processor features. For example, the instruction cache is enabled by setting the C_USE_ICACHE parameter. The size of the instruction cache, and the cacheable memory range, are all configurable using: C_CACHE_BYTE_SIZE, C_ICACHE_BASEADDR, and C_ICACHE_HIGHADDR respectively.

Parameters valid for the latest version of MicroBlaze are listed in the following table. Not all of these are recognized by older versions of MicroBlaze; however, the configurability is fully backward compatible.

Note: Shaded rows indicate that the parameter has a fixed value and *cannot* be modified.

Table 89: Configuration Parameters

Parameter Name	Feature/Description	Allowable Values	Default Value	Tool Assigned	VHDL Type
C_FAMILY	Target Family	Listed in Table 90: Parameter C_FAMILY Allowable Values	virtex7	yes	string
C_DATA_SIZE	Data Size 32 = 32-bit MicroBlaze 64 = 64-bit MicroBlaze	32, 64	32		integer
C_ADDR_SIZE	Address Size	32-64	32	NA	integer
C_DYNAMIC_BUS_SIZING	Legacy	1	1	NA	integer
C_SCO	Internal	0	0	NA	integer
C_AREA_OPTIMIZED	Select implementation optimization: 0 = Performance 1 = Area 2 = Frequency	0, 1, 2	0		integer
C_OPTIMIZATION	Reserved for future use	0	0	NA	integer
C_INTERCONNECT	Select interconnect 2 = AXI4 only 3 = AXI4 and ACE	2, 3	2		integer
C_ENDIANNES	Select endianness 1 = Little Endian	1	1	yes	integer
C_BASE_VECTORS ¹	Configurable base vectors	0x0 - 0xFFFFFFFF FFFFFFFF	0x0		std_logic_vector
C_FAULT_TOLERANT	Implement fault tolerance	0, 1	0	yes	integer
C_ECC_USE_CE_EXCEPTION	Generate exception for correctable ECC error	0,1	0		integer
C_LOCKSTEP_SLAVE	Lockstep Slave	0, 1	0		integer
C_TEMPORAL_DEPTH	Lockstep Temporal Depth	0 - 31	0		integer
C_AVOID_PRIMITIVES	Disallow FPGA primitives 0 = None 1 = SRL 2 = LUTRAM 3 = Both	0, 1, 2, 3	0		integer

Table 89: Configuration Parameters (cont'd)

Parameter Name	Feature/Description	Allowable Values	Default Value	Tool Assigned	VHDL Type
C_ENABLE_DISCRETE_PORTS	Show discrete ports	0, 1	0		integer
C_PVR	Processor version register mode selection 0 = None 1 = Basic 2 = Full	0, 1, 2	0		integer
C_PVR_USER1	Processor version register USER1 constant	0x00-0xff	0x00		std_logic_vector (0 to 7)
C_PVR_USER2	Processor version register USER2 constant	0x00000000-0xffffffff	0x00000000		std_logic_vector (0 to 31)
C_RESET_MSR_IE C_RESET_MSR_BIP C_RESET_MSR_ICE C_RESET_MSR_DCE C_RESET_MSR_EE C_RESET_MSR_EIP	Reset value for MSR register bits IE, BIP, ICE, DCE, EE, and EIP	Any combination of the individual bits	0x0000		std_logic
C_INSTANCE	Instance Name	Any instance name	microblaze	yes	string
C_D_AXI	Data side AXI interface	0, 1	0		integer
C_D_LMB	Data side LMB interface	0, 1	1		integer
C_I_AXI	Instruction side AXI interface	0, 1	0		integer
C_I_LMB	Instruction side LMB interface	0, 1	1		integer
C_LMB_DATA_SIZE	LMB interface data size	32, 64	32		integer
C_USE_BARREL	Include barrel shifter	0, 1	0		integer
C_USE_DIV	Include hardware divider	0, 1	0		integer
C_USE_HW_MUL	Include hardware multiplier 0 = None 1 = Mul32 2 = Mul64	0, 1, 2	1		integer
C_USE_FPU	Include hardware floating-point unit 0 = None 1 = Basic 2 = Extended	0, 1, 2	0		integer
C_USE_MSR_INSTR	Enable use of instructions: MSRSET and MSRCLR	0, 1	1		integer

Table 89: Configuration Parameters (cont'd)

Parameter Name	Feature/Description	Allowable Values	Default Value	Tool Assigned	VHDL Type
C_USE_PCMP_INSTR	Enable use of instructions: CLZ, PCMPBF, PCMPEQ, and PCMPNE	0, 1	1		integer
C_USE_REORDER_INSTR	Enable use of instructions: Reverse load, reverse store, and swap	0, 1	1		integer
C_UNALIGNED_EXCEPTIONS	Enable exception handling for unaligned data accesses	0, 1	0		integer
C_ILL_OPCODE_EXCEPTION	Enable exception handling for illegal op-code	0, 1	0		integer
C_M_AXI_I_BUS_EXCEPTION	Enable exception handling for M_AXI_I bus error	0, 1	0		integer
C_M_AXI_D_BUS_EXCEPTION	Enable exception handling for M_AXI_D bus error	0, 1	0		integer
C_DIV_ZERO_EXCEPTION	Enable exception handling for division by zero or division overflow	0, 1	0		integer
C_FPU_EXCEPTION	Enable exception handling for hardware floating-point unit exceptions	0, 1	0		integer
C_OPCODE_0x0_ILLEGAL	Detect opcode 0x0 as an illegal instruction	0,1	0		integer
C_FSL_EXCEPTION	Enable exception handling for Stream Links	0,1	0		integer
C_ECC_USE_CE_EXCEPTION	Generate Bus Error Exceptions for correctable errors	0,1	0		integer
C_USE_STACK_PROTECTION	Generate exception for stack overflow or stack underflow	0,1	0		integer
C_IMPRECISE_EXCEPTIONS	Allow imprecise exceptions for ECC errors in LMB memory	0,1	0		integer
C_DEBUG_ENABLED	MDM Debug interface 0 = None 1 = Basic 2 = Extended	0,1,2	1		integer
C_NUMBER_OF_PC_BRK	Number of hardware breakpoints	0-8	1		integer
C_NUMBER_OF_RD_ADDR_BRK	Number of read address watchpoints	0-4	0		integer

Table 89: Configuration Parameters (cont'd)

Parameter Name	Feature/Description	Allowable Values	Default Value	Tool Assigned	VHDL Type
C_NUMBER_OF_WR_ADDR_BRK	Number of write address watchpoints	0-4	0		integer
C_DEBUG_EVENT_COUNTERS	Number of Performance Monitor event counters	0-48	5		integer
C_DEBUG_LATENCY_COUNTERS	Number of Performance Monitor latency counters	0-7	1		integer
C_DEBUG_COUNTER_WIDTH	Performance Monitor counter width	32,48,64	32		integer
C_DEBUG_TRACE_SIZE	Trace Buffer size Embedded: 0, ≥ 8192 External: 0, 32 - 8192	0, 32, 64, 128, 256, 8192, 16384, 32768, 65536, 131072	8192		integer
C_DEBUG_PROFILE_SIZE	Profile Buffer size	0, 4096, 8192, 16384, 32768, 65536, 131072	0		integer
C_DEBUG_EXTERNAL_TRACE	External Program Trace	0,1	0	yes	integer
C_DEBUG_INTERFACE	Debug Interface: 0 = Debug Serial 1 = Debug Parallel 2 = AXI4-Lite	0,1,2	0		integer
C_ASYNC_INTERRUPT	Asynchronous Interrupt	0,1	0	yes	integer
C_ASYNC_WAKEUP	Asynchronous Wakeup	00,01,10,11	00	yes	integer
C_INTERRUPT_IS_EDGE	Level/Edge Interrupt	0, 1	0	yes	integer
C_EDGE_IS_POSITIVE	Negative/Positive Edge Interrupt	0, 1	1	yes	integer
C_FSL_LINKS	Number of AXI4-Stream interfaces	0-16	0		integer
C_USE_EXTENDED_FSL_INSTR	Enable use of extended stream instructions	0, 1	0		integer
C_ICACHE_BASEADDR	Instruction cache base address	0x0 - 0xFFFFFFFF FFFFFFFF	0x0		std_logic_vector
C_ICACHE_HIGHADDR	Instruction cache high address	0x0 - 0xFFFFFFFF FFFFFFFF	0x3FFFFFF F		std_logic_vector
C_USE_ICACHE	Instruction cache	0, 1	0		integer
C_ALLOW_ICACHE_WR	Instruction cache write enable	0, 1	1		integer
C_ICACHE_LINE_LEN	Instruction cache line length	4, 8, 16	4		integer

Table 89: Configuration Parameters (cont'd)

Parameter Name	Feature/Description	Allowable Values	Default Value	Tool Assigned	VHDL Type
C_ICACHE_ALWAYS_USED	Instruction cache interface used for all memory accesses in the cacheable range	0, 1	1		integer
C_ICACHE_FORCE_TAG_LUTRAM	Instruction cache tag always implemented with distributed RAM	0, 1	0		integer
C_ICACHE_STREAMS	Instruction cache streams	0, 1	0		integer
C_ICACHE_VICTIMS	Instruction cache victims	0, 2, 4, 8	0		integer
C_ICACHE_DATA_WIDTH	Instruction cache data width 0 = 32 bits 1 = Full cache line 2 = 512 bits	0, 1, 2	0		integer
C_ADDR_TAG_BITS	Instruction cache address tags	0-25	17	yes	integer
C_CACHE_BYTE_SIZE	Instruction cache size	64, 128, 256, 512, 1024, 2048, 4096, 8192, 16384, 32768, 65536 ¹	8192		integer
C_DCACHE_BASEADDR	Data cache base address	0x0 - 0xFFFFFFFFFFFFFFFF	0x0		std_logic_vector
C_DCACHE_HIGHADDR	Data cache high address	0x0 - 0xFFFFFFFFFFFFFFFF	0x3FFFFFFF		std_logic_vector
C_USE_DCACHE	Data cache	0, 1	0		integer
C_ALLOW_DCACHE_WR	Data cache write enable	0, 1	1		integer
C_DCACHE_LINE_LEN	Data cache line length	4, 8, 16	4		integer
C_DCACHE_ALWAYS_USED	Data cache interface used for all accesses in the cacheable range	0, 1	1		integer
C_DCACHE_FORCE_TAG_LUTRAM	Data cache tag always implemented with distributed RAM	0, 1	0		integer
C_DCACHE_USE_WRITEBACK	Data cache write-back storage policy used	0, 1	0		integer
C_DCACHE_VICTIMS	Data cache victims	0, 2, 4, 8	0		integer
C_DCACHE_DATA_WIDTH	Data cache data width 0 = 32 bits 1 = Full cache line 2 = 512 bits	0, 1, 2	0		integer

Table 89: Configuration Parameters (cont'd)

Parameter Name	Feature/Description	Allowable Values	Default Value	Tool Assigned	VHDL Type
C_DCACHE_ADDR_TAG	Data cache address tags	0-25	17	yes	integer
C_DCACHE_BYTE_SIZE	Data cache size	64, 128, 256, 512, 1024, 2048, 4096, 8192, 16384, 32768, 65536 ²	8192		integer
C_USE_MMU ³	Memory Management: 0 = None 1 = User Mode 2 = Protection 3 = Virtual	0, 1, 2, 3	0		integer
C_MMU_DTLB_SIZE ³	Data shadow Translation Look-Aside Buffer size	1, 2, 4, 8	4		integer
C_MMU_ITLB_SIZE ³	Instruction shadow Translation Look-Aside Buffer size	1, 2, 4, 8	2		integer
C_MMU_TLB_ACCESS ³	Access to memory management special registers: 0 = Minimal 1 = Read 2 = Write 3 = Full	0, 1, 2, 3	3		integer
C_MMU_ZONES ³	Number of memory protection zones	0-16	16		integer
C_MMU_PRIVILEGED_INSTR ³	Privileged instructions 0 = Full protection 1 = Allow stream instrs 2 = Allow extended addr 3 = Allow both	0,1,2,3	0		integer
C_USE_INTERRUPT	Enable interrupt handling 0 = No interrupt 1 = Standard interrupt 2 = Low-latency interrupt	0, 1, 2	1	yes	integer
C_USE_EXT_BRK	Enable external break handling	0,1	0	yes	integer
C_USE_EXT_NM_BRK	Enable external non-maskable break handling	0,1	0	yes	integer
C_USE_NON_SECURE	Use corresponding non-secure input	0-15	0	yes	integer

Table 89: Configuration Parameters (cont'd)

Parameter Name	Feature/Description	Allowable Values	Default Value	Tool Assigned	VHDL Type
C_USE_BRANCH_TARGET_CACHE ³	Enable Branch Target Cache	0,1	0		integer
C_BRANCH_TARGET_CACHE_SIZE ³	Branch Target Cache size: 0 = Default 1 = 8 entries 2 = 16 entries 3 = 32 entries 4 = 64 entries 5 = 512 entries 6 = 1024 entries 7 = 2048 entries	0-7	0		integer
C_M_AXI_DP_THREAD_ID_WIDTH	Data side AXI thread ID width	1	1		integer
C_M_AXI_DP_DATA_WIDTH	Data side AXI data width	32, 64	32		integer
C_M_AXI_DP_ADDR_WIDTH	Data side AXI address width	32-64	32	yes	integer
C_M_AXI_DP_SUPPORTS_THREADS	Data side AXI uses threads	0	0		integer
C_M_AXI_DP_SUPPORTS_READ	Data side AXI support for read accesses	1	1		integer
C_M_AXI_DP_SUPPORTS_WRITE	Data side AXI support for write accesses	1	1		integer
C_M_AXI_DP_SUPPORTS_NARROW_BURST	Data side AXI narrow burst support	0	0		integer
C_M_AXI_DP_PROTOCOL	Data side AXI protocol	AXI4, AXI4LITE	AXI4 LITE	yes	string
C_M_AXI_DP_EXCLUSIVE_ACCESS	Data side AXI exclusive access support	0,1	0		integer
C_M_AXI_IP_THREAD_ID_WIDTH	Instruction side AXI thread ID width	1	1		integer
C_M_AXI_IP_DATA_WIDTH	Instruction side AXI data width	32	32		integer
C_M_AXI_IP_ADDR_WIDTH	Instruction side AXI address width	32-64	32	yes	integer
C_M_AXI_IP_SUPPORTS_THREADS	Instruction side AXI uses threads	0	0		integer
C_M_AXI_IP_SUPPORTS_READ	Instruction side AXI support for read accesses	1	1		integer
C_M_AXI_IP_SUPPORTS_WRITE	Instruction side AXI support for write accesses	0	0		integer
C_M_AXI_IP_SUPPORTS_NARROW_BURST	Instruction side AXI narrow burst support	0	0		integer

Table 89: Configuration Parameters (cont'd)

Parameter Name	Feature/Description	Allowable Values	Default Value	Tool Assigned	VHDL Type
C_M_AXI_IP_PROTOCOL	Instruction side AXI protocol	AXI4LITE	AXI4LITE		string
C_M_AXI_DC_THREAD_ID_WIDTH	Data cache AXI ID width	1	1		integer
C_M_AXI_DC_DATA_WIDTH	Data cache AXI data width	32, 64, 128, 256, 512	32		integer
C_M_AXI_DC_ADDR_WIDTH	Data cache AXI address width	32-64	32	yes	integer
C_M_AXI_DC_SUPPORTS_THREADS	Data cache AXI uses threads	0	0		integer
C_M_AXI_DC_SUPPORTS_READ	Data cache AXI support for read accesses	1	1		integer
C_M_AXI_DC_SUPPORTS_WRITE	Data cache AXI support for write accesses	1	1		integer
C_M_AXI_DC_SUPPORTS_NARROW_BURST	Data cache AXI narrow burst support	0	0		integer
C_M_AXI_DC_SUPPORTS_USER_SIGNALS	Data cache AXI user signal support	1	1		integer
C_M_AXI_DC_PROTOCOL	Data cache AXI protocol	AXI4	AXI4		string
C_M_AXI_DC_AWUSER_WIDTH	Data cache AXI user width	5	5		integer
C_M_AXI_DC_ARUSER_WIDTH	Data cache AXI user width	5	5		integer
C_M_AXI_DC_WUSER_WIDTH	Data cache AXI user width	1	1		integer
C_M_AXI_DC_RUSER_WIDTH	Data cache AXI user width	1	1		integer
C_M_AXI_DC_BUSER_WIDTH	Data cache AXI user width	1	1		integer
C_M_AXI_DC_EXCLUSIVE_ACCESS	Data cache AXI exclusive access support	0,1	0		integer
C_M_AXI_DC_USER_VALUE	Data cache AXI user value	0-31	31		integer
C_M_AXI_IC_THREAD_ID_WIDTH	Instruction cache AXI ID width	1	1		integer
C_M_AXI_IC_DATA_WIDTH	Instruction cache AXI data width	32, 64, 128, 256, 512	32		integer
C_M_AXI_IC_ADDR_WIDTH	Instruction cache AXI address width	32-64	32	yes	integer
C_M_AXI_IC_SUPPORTS_THREADS	Instruction cache AXI uses threads	0	0		integer

Table 89: Configuration Parameters (cont'd)

Parameter Name	Feature/Description	Allowable Values	Default Value	Tool Assigned	VHDL Type
C_M_AXI_IC_SUPPORTS_READ	Instruction cache AXI support for read accesses	1	1		integer
C_M_AXI_IC_SUPPORTS_WRITE	Instruction cache AXI support for write accesses	0	0		integer
C_M_AXI_IC_SUPPORTS_NARROW_BURST	Instruction cache AXI narrow burst support	0	0		integer
C_M_AXI_IC_SUPPORTS_USER_SIGNALS	Instruction cache AXI user signal support	1	1		integer
C_M_AXI_IC_PROTOCOL	Instruction cache AXI protocol	AXI4	AXI4		string
C_M_AXI_IC_AWUSER_WIDTH	Instruction cache AXI user width	5	5		integer
C_M_AXI_IC_ARUSER_WIDTH	Instruction cache AXI user width	5	5		integer
C_M_AXI_IC_WUSER_WIDTH	Instruction cache AXI user width	1	1		integer
C_M_AXI_IC_RUSER_WIDTH	Instruction cache AXI user width	1	1		integer
C_M_AXI_IC_BUSER_WIDTH	Instruction cache AXI user width	1	1		integer
C_M_AXI_IC_USER_VALUE	Instruction cache AXI user value	0-31	31		integer
C_STREAM_INTERCONNECT	Select AXI4-Stream interconnect	0,1	0		integer
C_Mn_AXIS_PROTOCOL	AXI4-Stream protocol	GENERIC	GENERIC		string
C_Sn_AXIS_PROTOCOL	AXI4-Stream protocol	GENERIC	GENERIC		string
C_Mn_AXIS_DATA_WIDTH	AXI4-Stream master data width	32	32	NA	integer
C_Sn_AXIS_DATA_WIDTH	AXI4-Stream slave data width	32	32	NA	integer
C_NUM_SYNC_FF_CLK	Reset and Wakeup[0:1] synchronization stages	≥0	2		integer
C_NUM_SYNC_FF_CLK_IRQ	Interrupt input signal synchronization stages	≥0	1		integer
C_NUM_SYNC_FF_CLK_DEBUG	Dbg_serial signal synchronization stages	≥0	2		integer
C_NUM_SYNC_FF_DBG_CLK	Internal synchronization stages to Dbg_Clk	≥0	1		integer

Table 89: Configuration Parameters (cont'd)

Parameter Name	Feature/Description	Allowable Values	Default Value	Tool Assigned	VHDL Type
C_NUM_SYNC_FF_DBG_TRACE_CLK	Internal synchronization stages to Dbg_Trace_Clk	≥ 0	1		integer

Notes:

1. The 7 least significant bits must all be 0.
2. Not all sizes are permitted in all architectures. The cache uses 0 - 32 RAMB primitives (0 if cache size is less than 2048).
3. Not available when C_AREA_OPTIMIZED is set to 1 (Area).

Table 90: Parameter C_FAMILY Allowable Values

	Allowable Values
AMD Artix™	aartix7 artix7 artix7l qartix7 qartix7l artixuplus
Kintex	kintex7 kintex7l qkintex7 qkintex7l kintexu kintexuplus
Spartan	spartan7 spartanuplus
Virtex	qvirtex7 virtex7 virtexu virtexuplus virtexuplusHBM
AMD Zynq™	azynq zynq qzynq zynqplus zynqplusRFSOC
AMD Versal™	versal

MicroBlaze Application Binary Interface

Introduction

This chapter describes MicroBlaze™ Application Binary Interface (ABI), which is important for developing software in assembly language for the soft processor. The MicroBlaze GNU compiler follows the conventions described in this document. Any code written by assembly programmers should also follow the same conventions to be compatible with the compiler generated code. Interrupt and Exception handling is also explained briefly.

Data Types

The data types used by MicroBlaze assembly programs are shown in the following table. Data types such as `data8`, `data16`, `data32`, and `data64` are used in place of the usual `byte`, `half-word`, and `word.register`.

Table 91: Data Types in MicroBlaze Assembly Programs

MicroBlaze Data Types (for Assembly Programs)	Corresponding ANSI C Data Types 32-bit MicroBlaze	Corresponding ANSI C Data Types 64-bit MicroBlaze	Size (Bytes)
<code>data8</code>	<code>char</code>	<code>char</code>	1
<code>data16</code>	<code>short</code>	<code>short</code>	2
<code>data32</code>	<code>int</code>	<code>int</code>	4
	<code>long int</code>	-	4
	<code>float</code>	<code>float</code>	4
	<code>enum</code>	<code>enum</code>	4
<code>data16/data32</code>	<code>pointer¹</code>	-	2/4

Table 91: Data Types in MicroBlaze Assembly Programs (cont'd)

MicroBlaze Data Types (for Assembly Programs)	Corresponding ANSI C Data Types 32-bit MicroBlaze	Corresponding ANSI C Data Types 64-bit MicroBlaze	Size (Bytes)
data64	-	long int	8
	long long int	long long int	8
	-	double	8
	-	pointer	8

Notes:

1. Pointers to small data areas, which can be accessed by global pointers are data16.

Register Usage Conventions

The register usage convention for MicroBlaze is given in the following table.

Table 92: Register Usage Conventions

Register	Type	Enforcement	Purpose
R0	Dedicated	HW	Value 0
R1	Dedicated	SW	Stack Pointer
R2	Dedicated	SW	Read-only small data area anchor
R3-R4	Volatile	SW	Return Values/Temporaries
R5-R10	Volatile	SW	Passing parameters/Temporaries
R11-R12	Volatile	SW	Temporaries
R13	Dedicated	SW	Read-write small data area anchor
R14	Dedicated	HW	Return address for Interrupt
R15	Dedicated	SW	Return address for Sub-routine
R16	Dedicated	HW	Return address for Trap (Debugger)
R17	Dedicated	HW/SW	Return address for Exceptions HW, if configured to support hardware exceptions, else SW
R18	Dedicated	SW	Reserved for Assembler/Compiler Temporaries
R19	Non-volatile	SW	Must be saved across function calls. Callee-save
R20	Dedicated or Non-volatile	SW	Reserved for storing a pointer to the global offset table (GOT) in position independent code (PIC). Non-volatile in non-PIC code. Must be saved across function calls. Callee-save.
R21-R31	Non-volatile	SW	Must be saved across function calls. Callee-save.
RPC	Special	HW	Program counter
RMSR	Special	HW	Machine Status Register

Table 92: Register Usage Conventions (cont'd)

Register	Type	Enforcement	Purpose
REAR	Special	HW	Exception Address Register
RESR	Special	HW	Exception Status Register
RFSR	Special	HW	Floating-Point Status Register
RBTR	Special	HW	Branch Target Register
REDR	Special	HW	Exception Data Register
RPID	Special	HW	Process Identifier Register
RZPR	Special	HW	Zone Protection Register
RTLBLO	Special	HW	Translation Look-Aside Buffer Low Register
RTLBHI	Special	HW	Translation Look-Aside Buffer High Register
RTL BX	Special	HW	Translation Look-Aside Buffer Index Register
RTLBSX	Special	HW	Translation Look-Aside Buffer Search Index
RPVR0-12	Special	HW	Processor Version Register 0 through 12

The architecture for MicroBlaze defines 32 general purpose registers (GPRs). These registers are classified as volatile, non-volatile, and dedicated.

- The volatile registers (also known as caller-save) are used as temporaries and do not retain values across the function calls. Registers R3 through R12 are volatile, of which R3 and R4 are used for returning values to the caller function, if any. Registers R5 through R10 are used for passing parameters between subroutines.
- Registers R19 through R31 retain their contents across function calls and are hence termed as non-volatile registers (a.k.a callee-save). The callee function is expected to save those non-volatile registers, which are being used. These are typically saved to the stack during the prologue and then reloaded during the epilogue.
- Certain registers are used as dedicated registers and programmers are not expected to use them for any other purpose.
 - Registers R14 through R17 are used for storing the return address from interrupts, subroutines, traps, and exceptions in that order. Subroutines are called using the branch and link instruction, which saves the current Program Counter (PC) onto register R15.
 - Small data area pointers are used for accessing certain memory locations with 16-bit immediate value. These areas are discussed in the memory model section of this document. The read only small data area (SDA) anchor R2 (Read-Only) is used to access the constants such as literals. The other SDA anchor R13 (Read-Write) is used for accessing the values in the small data read-write section.
 - Register R1 stores the value of the stack pointer and is updated on entry and exit from functions.

- Register R18 is used as a temporary register for assembler operations.
- MicroBlaze includes special purpose registers such as:
 - program counter (rpc)
 - machine status register (rmsr)
 - exception status register (resr)
 - exception address register (rear)
 - floating-point status register (rfsr), branch target register (rbtr)
 - exception data register (redr)
 - memory management registers (rpid, rzpr, rtlblo, rtlbhi, rtlbx, rtlbsx)
 - processor version registers (0-12)

These registers are not mapped directly to the register file; and hence, the usage of these registers is different from the general purpose registers. The value of a special purpose registers can be transferred to or from a general purpose register by using mts and mfs instructions respectively.

Stack Convention

The stack conventions used by MicroBlaze are detailed in the following table.

The shaded area in the following table denotes a part of the stack frame for a caller function, while the unshaded area indicates the callee frame function. The ABI conventions of the stack frame define the protocol for passing parameters, preserving non-volatile register values, and allocating space for the local variables in a function.

Functions that contain calls to other subroutines are called as non-leaf functions. These non-leaf functions have to create a new stack frame area for its own use. When the program starts executing, the stack pointer has the maximum value. As functions are called, the stack pointer is decremented by the number of words required by every function for its stack frame. The stack pointer of a caller function always has a higher value as compared to the callee function.

Table 93: Stack Convention

High Address	
	Function Parameters for called sub-routine (Arg n .. Arg1) (Optional: Maximum number of arguments required for any called procedure from the current procedure).
Old Stack Pointer	Link Register (R15)
	Callee Saved Register (R31....R19) (Optional: Only those registers which are used by the current procedure are saved)
	Local Variables for Current Procedure (Optional: Present only if Locals defined in the procedure)
	Functional Parameters (Arg n .. Arg 1) (Optional: Maximum number of arguments required for any called procedure from the current procedure)
New Stack Pointer	Link Register
Low Address	

Consider an example where Func1 calls Func2, which in turn calls Func3. The stack representation at different instances is depicted in the following figure. After the call from Func 1 to Func 2, the value of the stack pointer (SP) is decremented. This value of SP is again decremented to accommodate the stack frame for Func3. On return from Func 3 the value of the stack pointer is increased to its original value in the function, Func 2.

Details of how the stack is maintained are shown in the following figure.

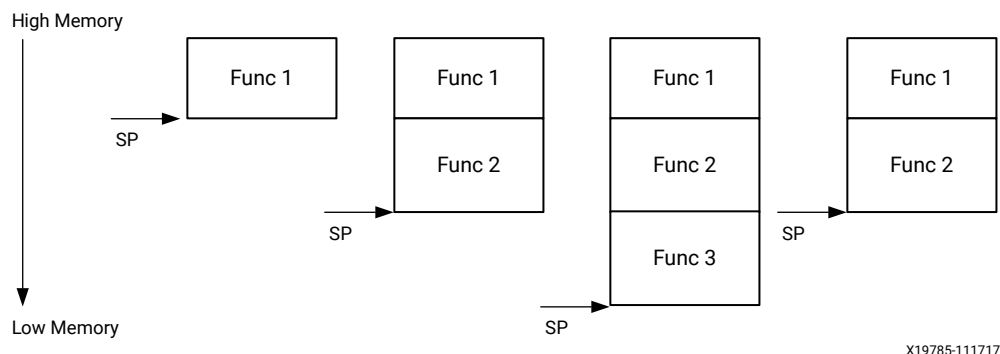
Figure 58: Stack Frame

X19785-111717

Stack protection is available to ensure that the stack does not grow above the high limit or shrink below the low limit. The Stack High Register (SHR) and Stack Low Register (SLR) are used to enforce this, respectively. These registers are automatically initialized to the stack limits from linker symbols by the `crto.o` initialization file.

Enabling stack protection in hardware can be useful to detect erroneous program behavior due to stack size issues, which can otherwise be very hard to debug.

Calling Convention

The caller function passes parameters to the callee function using either the registers (R5 through R10) or on its own stack frame. The callee uses the stack area of the caller to store the parameters passed to the callee.

See [Table 91: Data Types in MicroBlaze Assembly Programs](#). The parameters for Func 2 are stored either in the registers R5 through R10 or on the stack frame allocated for Func 1.

If Func 2 has more than six integer parameters, the first six parameters can be passed in registers R5 through R10, whereas all subsequent parameters must be passed on the stack frame allocated for Func 1, starting at offset SP + 28.

Should Func2 be a variable argument function (a variadic function) such as `printf()`, all variable arguments are stored on the stack frame allocated by the caller.

Memory Model

The memory model for MicroBlaze classifies the data into four different parts: Small Data Area, Data Area, Common Un-Initialized Area, and Literals or Constants.

Small Data Area

Global initialized variables which are small in size are stored in this area. The threshold for deciding the size of the variable to be stored in the small data area is set to 8 bytes in the MicroBlaze C compiler (mb-gcc), but this can be changed by giving a command line option to the compiler. Details about this option are discussed in the “GNU Compiler Tools” chapter of the *Vitis Unified Software Platform Documentation: Embedded Software Development (UG1400)*. 64 kilobytes of memory is allocated for the small data areas. The small data area is accessed using the read-write small data area anchor (R13) and a 16-bit offset. Allocating small variables to this area reduces the requirement of adding IMM instructions to the code for accessing global variables. Any variable in the small data area can also be accessed using an absolute address.

Data Area

Comparatively large initialized variables are allocated to the data area, which can either be accessed using the read-write SDA anchor R13 or using the absolute address, depending on the command line option given to the compiler.

Common Un-Initialized Area

Un-initialized global variables are allocated in the common area and can be accessed either using the absolute address or using the read-write small data area anchor R13.

Literals or Constants

Constants are placed into the read-only small data area and are accessed using the read-only small data area anchor R2.

The compiler generates appropriate global pointers to act as base pointers. The actual values of the SDA anchors are decided by the linker, in the final linking stages. For more information on the various sections of the memory see the “MicroBlaze Linker Scripts” section of the *Vitis Unified Software Platform Documentation: Embedded Software Development* ([UG1400](#)).

The compiler generates appropriate sections, depending on the command line options. See the “GNU Compiler Tools” chapter in the *Vitis Unified Software Platform Documentation: Embedded Software Development* ([UG1400](#)) for more information about these options.

Interrupt, Break, and Exception Handling

MicroBlaze assumes certain address locations for handling interrupts and exceptions as indicated in the following table. At these locations, code is written to jump to the appropriate handlers.

Table 94: Interrupt and Exception Handling

On	Hardware jumps to	Software Labels
Start / Reset	C_BASE_VECTORS + 0x0	_start
User exception	C_BASE_VECTORS + 0x8	_exception_handler
Interrupt	C_BASE_VECTORS + 0x10 ¹	_interrupt_handler
Break (HW/SW)	C_BASE_VECTORS + 0x18	-
Hardware exception	C_BASE_VECTORS + 0x20	_hw_exception_handler
Reserved	C_BASE_VECTORS + 0x28 - C_BASE_VECTORS + 0x4F	-

Notes:

1. With low-latency interrupt mode, the vector address is supplied by the Interrupt Controller.

The code expected at these locations is as shown below. The `crtr0.o` initialization file is passed by the `mb-gcc` compiler to the `mb-ld` linker for linking. This file sets the appropriate addresses of the exception handlers.

The following is code for passing control to Exception, Break, and Interrupt handlers, assuming the default `C_BASE_VECTORS` value of `0x00000000`:

```
0x00:  bri  _start1
0x04:  nop
0x08:  imm  high bits of address (user exception handler)
0x0c:  bri  _exception_handler
0x10:  imm  high bits of address (interrupt handler)
0x14:  bri  _interrupt_handler
0x18:  imm  high bits of address (break handler)
0x1c:  bri  low bits of address (break handler)
0x20:  imm  high bits of address (HW exception handler)
0x24:  bri  _hw_exception_handler
```

With low-latency interrupt mode, control is directly passed to the interrupt handler for each individual interrupt utilizing this mode. In this case, it is the responsibility of each handler to save and restore used registers. The MicroBlaze C compiler (`mb-gcc`) attribute `fast_interrupt` is available to allow this task to be performed by the compiler:

```
void interrupt_handler_name() __attribute__((fast_interrupt));
```

MicroBlaze allows exception and interrupt handler routines to be located at any address location addressable using 32 bits.

- The user exception handler code starts with the label `_exception_handler`
- The hardware exception handler starts with `_hw_exception_handler`
- The interrupt handler code starts with the label `_interrupt_handler` for interrupts that do not use low-latency handlers.

In the current MicroBlaze system, there are dummy routines for interrupt, break, and user exception handling, which you can change. In order to override these routines and link your own interrupt and exception handlers, you must define the handler code with specific attributes.

The interrupt handler code must be defined with attribute `interrupt_handler` to ensure that the compiler will generate code to save and restore used registers and emit an `rtid` instruction to return from the handler:

```
void function_name() __attribute__((interrupt_handler));
```

The break handler code must be defined with attribute `break_handler` to ensure that the compiler will generate code to save and restore used registers and emit an `rtbd` instruction to return from the handler:

```
void function_name() __attribute__((break_handler));
```

For more details about the use and syntax of the interrupt handler attribute, refer to the GNU Compiler Tools chapter in the *Vitis Unified Software Platform Documentation: Embedded Software Development* ([UG1400](#)).

When software breakpoints are used in the Xilinx System Debugger (XSDB) tool or the AMD Vitis™ Development Environment, the Break (HW/SW) address location is reserved for handling the software breakpoint.

Reset Handling

After programming the FPGA, the MicroBlaze instruction and data caches are invalidated. However, because hardware reset does not invalidate the instruction and data caches, this has to be done by software before enabling the caches, to avoid using any stale data. With the Standalone BSP, this can be achieved by the code below.

```
#include <xil_cache.h>

int main()
{
    Xil_ICacheInvalidate();
    Xil_ICacheEnable();
    Xil_DCacheInvalidate();
    Xil_DCacheEnable();
    ...
}
```

It is also possible to call these functions from a custom first stage initialization file, if startup times are critical. See the *Vitis Unified Software Platform Documentation: Embedded Software Development* ([UG1400](#)) for a detailed description of MicroBlaze initialization files.

ELF Format

The executable, object code and shared library format used by MicroBlaze tool chain is the Executable and Linkable Format (ELF). This section describes the specific use of the ELF format in the MicroBlaze architecture.

For further details on the format, see the [Tool Interface Standard \(TIS\) Executable and Linking Format \(ELF\) Specification](#).

File Header

The ELF header architecture-specific fields are listed in the following table, showing the values for the three available formats: 32-bit big-endian, 32-bit little-endian and 64-bit little-endian.

In object file dumps, the formats are denoted elf32-microblaze, elf32-microblazeel, and elf64-microblazeel respectively.

Table 95: ELF Header

Field	32-bit Big Endian	32-bit Little Endian	64-bit Little Endian
	C_DATA_SIZE = 32 C_ENDIANNES = 0	C_DATA_SIZE = 32 C_ENDIANNES = 1	C_DATA_SIZE = 64 C_ENDIANNES = 1
e_ident[EL_CLASS]	ELFCLASS32 (0x01)	ELFCLASS32 (0x01)	ELFCLASS64 (0x02)
e_ident[EL_DATA]	ELFDATA2MSB (0x02)	ELFDATA2LSB (0x01)	ELFDATA2LSB (0x01)
e_machine	EM_MICROBLAZE (189 = 0x00bd)		
e_entry	C_BASE_VECTORS		
e_flags	0x00000000		

Sections

The architecture does not define any special section indexes, types, or attribute flags.

Sections containing code must be at least 32-bit aligned, and sections containing data must be at least 32-bit aligned with 32-bit formats or at least 64-bit aligned with 64-bit format.

MicroBlaze special sections are listed in the following table.

Table 96: Special Sections

Name	Type	Attributes
.vectors.reset	SHT_PROGBITS	SHF_ALLOC+SHF_EXECINSTR
.vectors.sw_exception	SHT_PROGBITS	SHF_ALLOC+SHF_EXECINSTR
.vectors.interrupt	SHT_PROGBITS	SHF_ALLOC+SHF_EXECINSTR
.vectors.hw_exception	SHT_PROGBITS	SHF_ALLOC+SHF_EXECINSTR

Relocations

Relocation information is used by linkers to bind symbols and addresses that could not be determined when the initial object was generated.

Relocation entries describe how to alter the instruction and data relocation fields. Relocations applied to executable or shared object files are similar and accomplish the same result.

All relocations are listed and described in the following table, including the operation performed to compute the value of the relocation.

Table 97: Relocation Entries

Code	Name	Description	Operation
1	R_MICROBLAZE_NONE	This relocation does nothing.	none

Table 97: Relocation Entries (cont'd)

Code	Name	Description	Operation
2	R_MICROBLAZE_32	A standard 32 bit relocation.	S+A
3	R_MICROBLAZE_32_PCREL	A standard PCREL 32 bit relocation.	S+A-P
4	R_MICROBLAZE_64_PCREL	A 64 bit PCREL relocation. Table-entry only used for 64-bit implementation.	(S+A-P)&0xFFFF (#imm)
5	R_MICROBLAZE_32_PCREL_LO	The low half of a PCREL 32 bit relocation.	(S+A-P)&0xFFFF
6	R_MICROBLAZE_64	A 64 bit relocation. Table entry only used for 64-bit implementation.	(S+A)&0xFFFF (#imm)
7	R_MICROBLAZE_32_LO	The low half of a 32 bit relocation.	(S+A)&0xFFFF
8	R_MICROBLAZE_SRO32	Read-only small data section relocation.	(S+A -_SDA_BASE_)
9	R_MICROBLAZE_SRW32	Read-write small data area relocation.	(S+A-_SDA_BASE_)
10	R_MICROBLAZE_64_NONE	This relocation does nothing. Used for relaxation.	none
11	R_MICROBLAZE_32_SYM_OP_SYM	Symbol Op Symbol relocation.	none
12	R_MICROBLAZE_GNU_VTINHERIT	GNU extension to record C++ vtable hierarchy.	
13	R_MICROBLAZE_GNU_VTENTRY	GNU extension to record C++ vtable member usage.	
14	R_MICROBLAZE_GOTPC_64	A 64 bit GOTPC relocation. Table-entry only used for 64-bit implementation.	G+A-P (#imm)
15	R_MICROBLAZE_GOT_64	A 64 bit GOT relocation. Table-entry only used for 64-bit implementation.	G+A (#imm)
16	R_MICROBLAZE_PLT_64	A 64 bit PLT relocation. Table-entry only used for 64-bit implementation.	L+A (#imm)
17	R_MICROBLAZE_REL	Table-entry not used.	((B + A)>>16) & 0xFFFF
18	R_MICROBLAZE_JUMP_SLOT	Table-entry not used.	(S >> 16) & 0xFFFF
19	R_MICROBLAZE_GLOB_DAT	Table-entry not used.	(S >> 16) & 0xFFFF
20	R_MICROBLAZE_GOTOFF_64	A 64 bit GOT relative relocation.	(S+A-GOT)&0xFFFF
21	R_MICROBLAZE_GOTOFF_32	A 32 bit GOT relative relocation.	(S+A-GOT)&0xFFFF
22	R_MICROBLAZE_COPY	COPY relocation.	none
23	R_MICROBLAZE_TLS	TLS relocations for TLS.	none
24	R_MICROBLAZE_TLSGD	TLSGD relocations for TLS.	@got@tlsgd
25	R_MICROBLAZE_TLSLD	TLSLD relocations for TLS.	@got@tlsld
26	R_MICROBLAZE_TLSDTPMOD32	Computes the load module.	@got@dtplib
27	R_MICROBLAZE_TLSDTPREL32	Computes a dtv-relative displacement.	@got@dtplib
28	R_MICROBLAZE_TLSDTPREL64	Computes a dtv-relative displacement.	@got@dtplib

Table 97: Relocation Entries (cont'd)

Code	Name	Description	Operation
29	R_MICROBLAZE_TLSGOTPREL32	Computes a tp-relative displacement.	@got@prel
30	R_MICROBLAZE_TLSTPREL32	Computes a tp-relative displacement.	@got@prel
31	R_MICROBLAZE_32_NONE	Standard 32-bit relocation.	none

The symbol nomenclature and relocation calculations with thread-local symbols used in the relocation entries table are explained in the following table.

Table 98: Symbol Notation

Symbol	Meaning
A	The addend used to compute the value of the relocatable field.
B	The base address at which a shared object has been loaded into memory during execution. Generally, a shared object file is built with a 0 base virtual address, but the execution address will be different.
G	The offset into the global offset table at which the address of the relocation entry's symbol will reside during execution.
GOT	The address of the global offset table.
L	The place (section offset or address) of the procedure linkage table entry for a symbol. A procedure linkage table entry redirects a function call to the proper destination. The link editor builds the initial procedure linkage table, and the dynamic linker modifies the entries during execution.
P	The place (section offset or address) of the storage unit being relocated (computed using <code>r_offset</code>).
S	The value of the symbol whose index resides in the relocation entry.
@dtpmod	Computes the load module index of the load module that contain the definition of a symbol. The addend, if present, is ignored
@dtprel	Computes a dtv-relative displacement, the difference between the value of <code>S + A</code> and the base address of the thread-local storage block that contains the definition of the symbol, minus <code>0x8000</code> .
@got@tlsgd	Allocates entries in the GOT to hold a <code>tls_index</code> structure, with values <code>@dtpmod</code> and <code>@dtprel</code> , and computes the offset to the first entry relative to the TOC base.
@got@tlsld	Allocates entries in the GOT to hold a <code>tls_index</code> structure, with values <code>@dtpmod</code> and zero, and computes the offset to the first entry relative to the TOC base.
@got@dtpmod	Computes the load module index of the load module that contains the definition of its TLS symbol.
@got@dtprel	Computes a dtv-relative displacement, the difference between the value of <code>symbol + add</code> and the base address of the thread-local storage block that contains the definition of the symbol, minus <code>0x8000</code> . Used for initializing GOT.
@got@prel	Computes a tp-relative displacement, the difference between the value of <code>symbol + add</code> and the value of the thread pointer (<code>r13</code>).
#imm	Inserts <code>imm</code> instruction if the immediate value is greater than 16 bits in the instruction.

MicroBlaze Instruction Set Architecture

Introduction

This chapter provides a detailed guide to the Instruction Set Architecture of the MicroBlaze™ processor.

Notation

The symbols used throughout this chapter are defined in the following tables.

Table 99: Register Name Notation

Register Name	Mode	Meaning
rD	32-bit	Destination register r0 - r31, 32 bits: Entire register assigned instruction result
	64-bit	Destination register r0 - r31, 64 bits: 32 least significant bits assigned instruction result 32 most significant bits cleared to 0
rA rB	32-bit	Source register r0 - r31, 32 bits: Entire register used as instruction operand
	64-bit	Source register r0 - r31, 64 bits: 32 least significant bits used as instruction operand 32 most significant bits ignored
rD _L	64-bit	Destination register r0 - r31, 64 bits: Entire register assigned instruction result
rA _L rB _L	64-bit	Source register r0 - r31, 64 bits: Entire register used as instruction operand
rD _x	32-bit	Destination register r0 - r31:
	64-bit	Entire register assigned instruction result

Table 99: Register Name Notation (cont'd)

Register Name	Mode	Meaning
r _{Ax} r _{Bx}	32-bit	Source register r0 - r31, 32 bits: Entire register used as instruction operand
	64-bit	Source register r0 - r31, 64 bits: Entire register used as instruction operand

Table 100: Symbol Notation

Symbol	Meaning
+	Add
-	Subtract
x	Multiply
/	Divide
^	Bitwise logical AND
v	Bitwise logical OR
⊕	Bitwise logical XOR
x	Bitwise logical complement of x
←	Assignment
>>	Right shift
<<	Left shift
rx	Register x
x[i]	Bit i in register x
x[i:j]	Bits i through j in register x
=	Equal comparison
≠	Not equal comparison
>	Greater than comparison
>=	Greater than or equal comparison
<	Less than comparison
<=	Less than or equal comparison
	Signal choice
sext(x)	Sign-extend x
Mem(x)	Memory location at address x
FSLx	AXI4-Stream interface x
LSW(x)	Least Significant Word of x
isDnz(x)	Floating-point: true if x is denormalized
isInfinite(x)	Floating-point: true if x is +∞ or -∞
isPosInfinite(x)	Floating-point: true if x is +∞
isNegInfinite(x)	Floating-point: true if x -∞
isNaN(x)	Floating-point: true if x is a quiet or signaling NaN
isZero(x)	Floating-point: true if x is +0 or -0

Table 100: Symbol Notation (cont'd)

Symbol	Meaning
isQuietNaN(x)	Floating-point: true if x is a quiet NaN
isSigNaN(x)	Floating-point: true if x is a signaling NaN
signZero(x)	Floating-point: return +0 for $x > 0$, and -0 if $x < 0$
signInfinite(x)	Floating-point: return +∞ for $x > 0$, and -∞ if $x < 0$

Formats

MicroBlaze uses two instruction formats: Type A and Type B.

Type A

Type A is used for register-register instructions. It contains the opcode, one destination and two source registers.

Table 101: Type A Instruction Formats

Opcode	Destination Reg	Source Reg A	Source Reg B	0	0	0	0	0	0	0	0	0	0	0	0
0	6	11	16	21											31

Type B

Type B is used for register-immediate instructions. It contains the opcode, one destination and one source registers, and a source 16-bit immediate value.

Table 102: Type B Instruction Formats

Opcode	Destination Reg	Source Reg A	Immediate Value														
0	6	11	16														31

MicroBlaze 32-bit Instructions

This section provides descriptions of MicroBlaze instructions. Instructions are listed in alphabetical order. For each instruction the mnemonic, encoding, a description, pseudocode of its semantics, and a list of registers that it modifies are provided.

All instructions included in the instruction set for 32-bit MicroBlaze are defined in this section. These instructions are also available as part of the extended instruction set for 64-bit MicroBlaze.

Notes

- The C bit in the instruction opcode is not the same as the carry bit in the MSR.
- The “add r0, r0, r0” (= 0x00000000) instruction is never used by the compiler and usually indicates uninitialized memory. If you are using illegal instruction exceptions you can trap these instructions by setting the MicroBlaze parameter `C_OPCODE_0x0_ILLEGAL=1`.

addi

Figure 60: **addi**

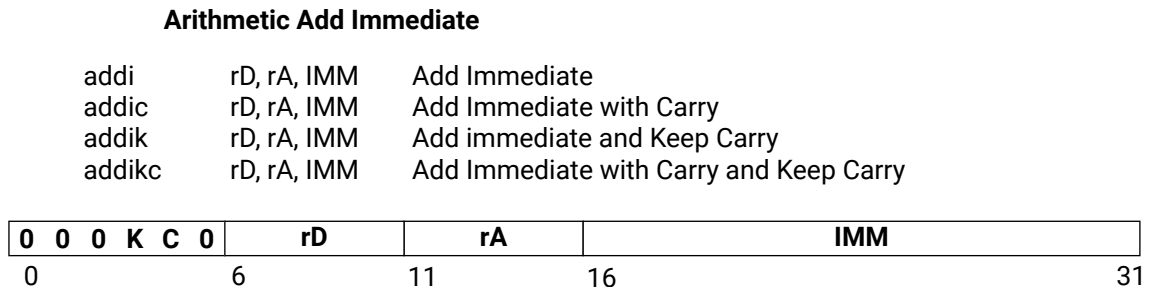

Description

The sum of the contents of registers rA and the value in the IMM field, sign-extended to 32 bits, is placed into register rD. Bit 3 of the instruction (labeled as K in the figure) is set to one for the mnemonic addik. Bit 4 of the instruction (labeled as C in the figure) is set to one for the mnemonic addic. Both bits are set to one for the mnemonic addikc.

When an addi instruction has bit 3 set (addik, addikc), the carry flag will keep its previous value regardless of the outcome of the execution of the instruction. If bit 3 is cleared (addi, addic), then the carry flag will be affected by the execution of the instruction.

When bit 4 of the instruction is set to one (addic, addikc), the content of the carry flag (MSR[C]) affects the execution of the instruction. When bit 4 is cleared (addi, addik), the content of the carry flag does not affect the execution of the instruction (providing a normal addition).

Pseudocode

```

if C = 0 then
    (rD) ← (rA) + sext(IMM)
else
    (rD) ← (rA) + sext(IMM) + MSR[C]
if K = 0 then
    MSR[C] ← CarryOut
    
```

Registers Altered

- rD
- MSR[C]

Latency

1 cycle

Notes

- The C bit in the instruction opcode is not the same as the carry bit in the MSR.
- By default, Type B Instructions take the 16-bit IMM field value and sign extend it to 32 bits to use as the immediate operand. This behavior can be overridden by preceding the Type B instruction with an `imm` instruction. See the instruction [imm](#) for details on using 32-bit immediate values.

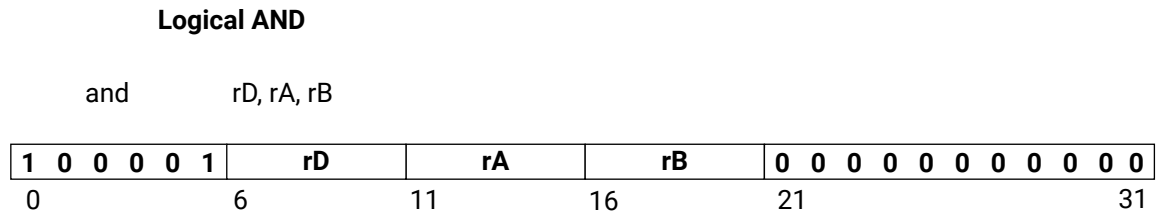
and*Figure 61: and***Description**

The contents of register rA are ANDed with the contents of register rB; the result is placed into register rD.

Pseudocode

```
(rD) ← (rA) ∧ (rB)
```

Registers Altered

rD

Latency

1 cycle

andi

Figure 62: andi

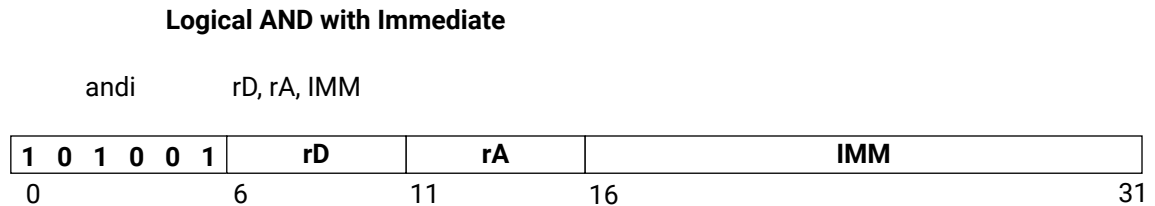

Description

The contents of register rA are ANDed with the value of the IMM field, sign-extended to 32 bits; the result is placed into register rD.

Pseudocode

```
(rD) ← (rA) ∧ sext(IMM)
```

Registers Altered

- rD

Latency

1 cycle

Note

By default, Type B Instructions will take the 16-bit IMM field value and sign extend it to 32 bits to use as the immediate operand. This behavior can be overridden by preceding the Type B instruction with an imm instruction. See the instruction [imm](#) for details on using 32-bit immediate values.

andni

Figure 64: **andni**

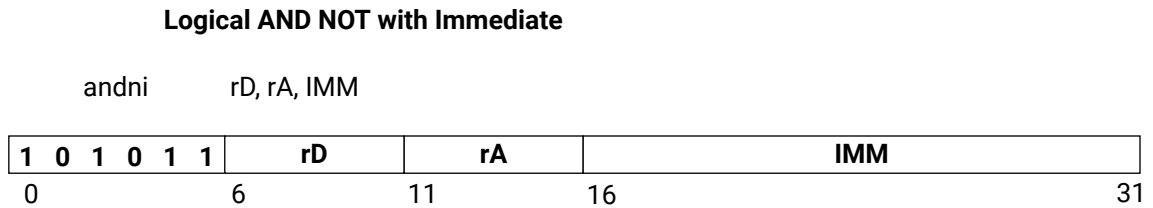

Description

The IMM field is sign-extended to 32 bits. The contents of register rA are ANDed with the logical complement of the extended IMM field; the result is placed into register rD.

Pseudocode

```
(rD) ← (rA) ∧ (sext(IMM))
```

Registers Altered

- rD

Latency

1 cycle

Note

By default, Type B Instructions will take the 16-bit IMM field value and sign extend it to 32 bits to use as the immediate operand. This behavior can be overridden by preceding the Type B instruction with an `imm` instruction. See the instruction [imm](#) for details on using 32-bit immediate values.

beq

Figure 65: beq

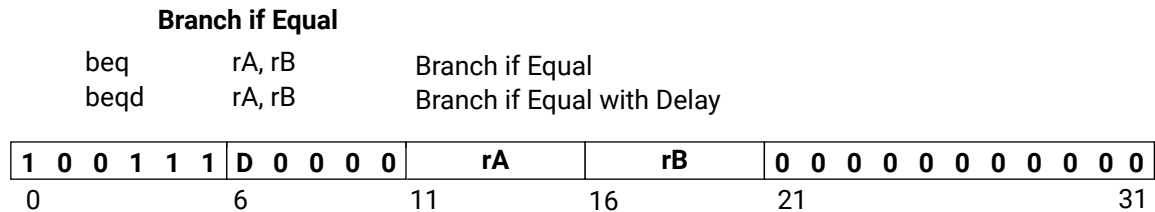

Description

Branch if rA is equal to 0, to the instruction located in the offset value of rB. The target of the branch will be the instruction at address PC + rB.

The mnemonic beqd will set the D bit. The D bit determines whether there is a branch delay slot or not. If the D bit is set, it means that there is a delay slot and the instruction following the branch (that is, in the branch delay slot) is allowed to complete execution before executing the target instruction. If the D bit is not set, it means that there is no delay slot, so the instruction to be executed after the branch is the target instruction.

Pseudocode

```

If rA = 0 then
    PC ← PC + rB
else
    PC ← PC + 4
if D = 1 then
    allow following instruction to complete execution
    
```

Registers Altered

- PC

Latency

- 1 cycle (if branch is not taken)
- 2 cycles (if branch is taken and the D bit is set with C_AREA_OPTIMIZED≠2)
- 3 cycles (if branch is taken and the D bit is not set with C_AREA_OPTIMIZED≠2)
- 6 cycles (if branch is taken and the D bit is set with C_AREA_OPTIMIZED=2)
- 7 cycles (if branch is taken and the D bit is not set with C_AREA_OPTIMIZED=2)

If C_USE_MMU > 1 two additional cycles are added with C_AREA_OPTIMIZED=2.

Note

A delay slot must not be used by the following: imm, branch, or break instructions. Interrupts and external hardware breaks are deferred until after the delay slot branch has been completed.

Notes

- By default, Type B Instructions will take the 16-bit IMM field value and sign extend it to 32 bits to use as the immediate operand. This behavior can be overridden by preceding the Type B instruction with an imm instruction. See the instruction [imm](#) for details on using 32-bit immediate values.
- A delay slot must not be used by the following: imm, branch, or break instructions. Interrupts and external hardware breaks are deferred until after the delay slot branch has been completed.

bge

Figure 67: **bge**

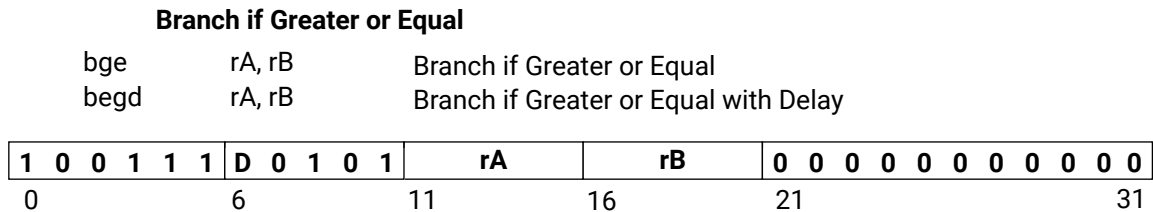

Description

Branch if rA is greater or equal to 0, to the instruction located in the offset value of rB. The target of the branch will be the instruction at address PC + rB.

The mnemonic begd will set the D bit. The D bit determines whether there is a branch delay slot or not. If the D bit is set, it means that there is a delay slot and the instruction following the branch (that is, in the branch delay slot) is allowed to complete execution before executing the target instruction. If the D bit is not set, it means that there is no delay slot, so the instruction to be executed after the branch is the target instruction.

Pseudocode

```

If rA >= 0 then
    PC ← PC + rB
else
    PC ← PC + 4
if D = 1 then
    allow following instruction to complete execution
    
```

Registers Altered

- PC

Latency

- 1 cycle (if branch is not taken)
- 2 cycles (if branch is taken and the D bit is set with C_AREA_OPTIMIZED≠2)
- 3 cycles (if branch is taken and the D bit is not set with C_AREA_OPTIMIZED≠2)
- 6 cycles (if branch is taken and the D bit is set with C_AREA_OPTIMIZED=2)
- 7 cycles (if branch is taken and the D bit is not set with C_AREA_OPTIMIZED=2)

If C_USE_MMU > 1 two additional cycles are added with C_AREA_OPTIMIZED=2.

Note

A delay slot must not be used by the following: imm, branch, or break instructions. Interrupts and external hardware breaks are deferred until after the delay slot branch has been completed.

bgei

Figure 68: bgei

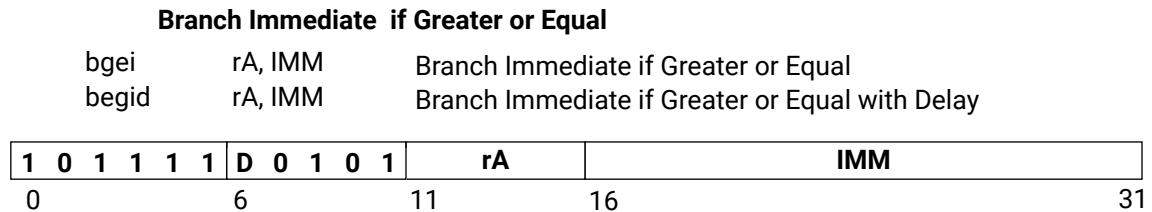

Description

Branch if rA is greater or equal to 0, to the instruction located in the offset value of IMM. The target of the branch will be the instruction at address PC + IMM.

The mnemonic bgeid will set the D bit. The D bit determines whether there is a branch delay slot or not. If the D bit is set, it means that there is a delay slot and the instruction following the branch (that is, in the branch delay slot) is allowed to complete execution before executing the target instruction. If the D bit is not set, it means that there is no delay slot, so the instruction to be executed after the branch is the target instruction.

Pseudocode

```

If rA >= 0 then
    PC ← PC + sext(IMM)
else
    PC ← PC + 4
if D = 1 then
    allow following instruction to complete execution
    
```

Registers Altered

- PC

Latency

- 1 cycle (if branch is not taken, or successful branch prediction occurs)
- 2 cycles (if branch is taken and the D bit is set with C_AREA_OPTIMIZED≠2)
- 3 cycles (if branch is taken and the D bit is not set with C_AREA_OPTIMIZED≠2, or a branch prediction mispredict occurs with C_AREA_OPTIMIZED=0)
- 6 cycles (if branch is taken and the D bit is set with C_AREA_OPTIMIZED=2)
- 7 cycles (if branch is taken and the D bit is not set, or if branch prediction mispredict occurs with C_AREA_OPTIMIZED=2)

If C_USE_MMU > 1 two additional cycles are added with C_AREA_OPTIMIZED=2.

Notes

- By default, Type B Instructions will take the 16-bit IMM field value and sign extend it to 32 bits to use as the immediate operand. This behavior can be overridden by preceding the Type B instruction with an `imm` instruction. See the instruction [imm](#) for details on using 32-bit immediate values.
- A delay slot must not be used by the following: `imm`, `branch`, or `break` instructions. Interrupts and external hardware breaks are deferred until after the delay slot branch has been completed.

bgt

Figure 69: **bgt**

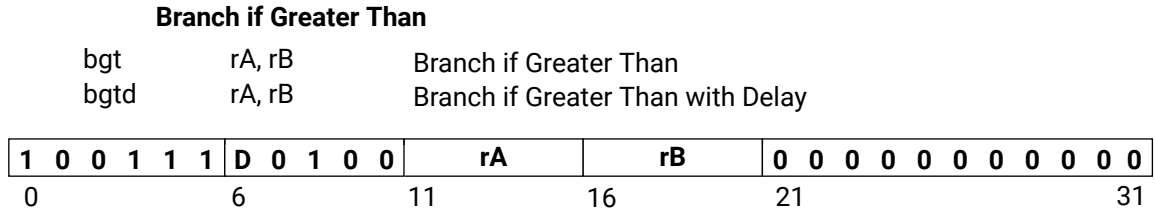

Description

Branch if rA is greater than 0, to the instruction located in the offset value of rB. The target of the branch will be the instruction at address PC + rB.

The mnemonic bgtD will set the D bit. The D bit determines whether there is a branch delay slot or not. If the D bit is set, it means that there is a delay slot and the instruction following the branch (that is, in the branch delay slot) is allowed to complete execution before executing the target instruction. If the D bit is not set, it means that there is no delay slot, so the instruction to be executed after the branch is the target instruction.

Pseudocode

```

If rA > 0 then
    PC ← PC + rB
else
    PC ← PC + 4
if D = 1 then
    allow following instruction to complete execution
    
```

Registers Altered

- PC

Latency

- 1 cycle (if branch is not taken)
- 2 cycles (if branch is taken and the D bit is set with C_AREA_OPTIMIZED≠2)
- 3 cycles (if branch is taken and the D bit is not set with C_AREA_OPTIMIZED≠2)
- 6 cycles (if branch is taken and the D bit is set with C_AREA_OPTIMIZED=2)
- 7 cycles (if branch is taken and the D bit is not set with C_AREA_OPTIMIZED=2)

If C_USE_MMU > 1 two additional cycles are added with C_AREA_OPTIMIZED=2.

Note

A delay slot must not be used by the following: imm, branch, or break instructions. Interrupts and external hardware breaks are deferred until after the delay slot branch has been completed.

bgti

Figure 70: bgti

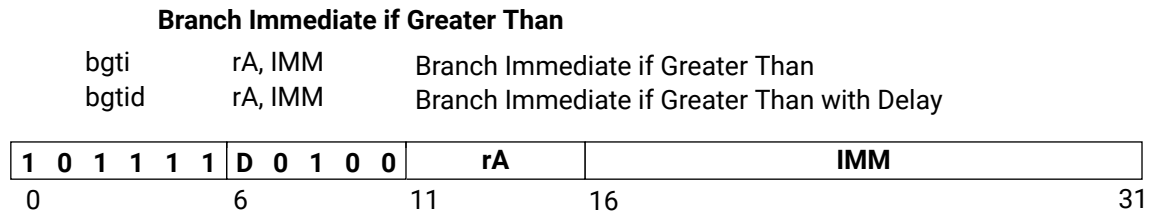

Description

Branch if rA is greater than 0, to the instruction located in the offset value of IMM. The target of the branch will be the instruction at address PC + IMM.

The mnemonic bgtid will set the D bit. The D bit determines whether there is a branch delay slot or not. If the D bit is set, it means that there is a delay slot and the instruction following the branch (that is, in the branch delay slot) is allowed to complete execution before executing the target instruction. If the D bit is not set, it means that there is no delay slot, so the instruction to be executed after the branch is the target instruction.

Pseudocode

```

If rA > 0 then
    PC ← PC + sext(IMM)
else
    PC ← PC + 4
if D = 1 then
    allow following instruction to complete execution
    
```

Registers Altered

- PC

Latency

- 1 cycle (if branch is not taken, or successful branch prediction occurs)
- 2 cycles (if branch is taken and the D bit is set with C_AREA_OPTIMIZED≠2)
- 3 cycles (if branch is taken and the D bit is not set with C_AREA_OPTIMIZED≠2, or a branch prediction mispredict occurs with C_AREA_OPTIMIZED=0)
- 6 cycles (if branch is taken and the D bit is set with C_AREA_OPTIMIZED=2)
- 7 cycles (if branch is taken and the D bit is not set, or if branch prediction mispredict occurs with C_AREA_OPTIMIZED=2)

If C_USE_MMU > 1 two additional cycles are added with C_AREA_OPTIMIZED=2.

Notes

- By default, Type B Instructions will take the 16-bit IMM field value and sign extend it to 32 bits to use as the immediate operand. This behavior can be overridden by preceding the Type B instruction with an `imm` instruction. See the instruction [imm](#) for details on using 32-bit immediate values.
- A delay slot must not be used by the following: `imm`, `branch`, or `break` instructions. Interrupts and external hardware breaks are deferred until after the delay slot branch has been completed.

ble

Figure 71: ble

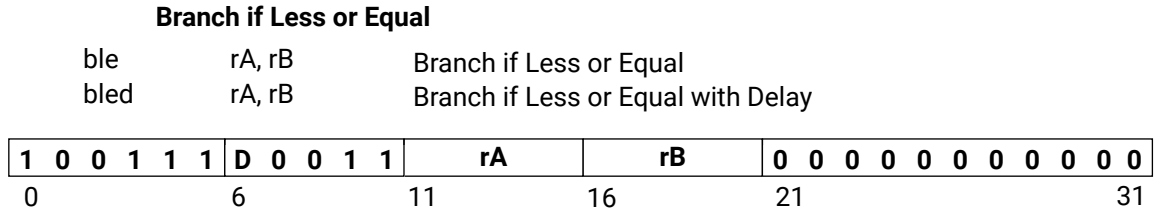

Description

Branch if rA is less or equal to 0, to the instruction located in the offset value of rB. The target of the branch will be the instruction at address PC + rB.

The mnemonic bled will set the D bit. The D bit determines whether there is a branch delay slot or not. If the D bit is set, it means that there is a delay slot and the instruction following the branch (that is, in the branch delay slot) is allowed to complete execution before executing the target instruction. If the D bit is not set, it means that there is no delay slot, so the instruction to be executed after the branch is the target instruction.

Pseudocode

```

If rA <= 0 then
    PC ← PC + rB
else
    PC ← PC + 4
if D = 1 then
    allow following instruction to complete execution
    
```

Registers Altered

- PC

Latency

- 1 cycle (if branch is not taken)
- 2 cycles (if branch is taken and the D bit is set with C_AREA_OPTIMIZED≠2)
- 3 cycles (if branch is taken and the D bit is not set with C_AREA_OPTIMIZED≠2)
- 6 cycles (if branch is taken and the D bit is set with C_AREA_OPTIMIZED=2)
- 7 cycles (if branch is taken and the D bit is not set with C_AREA_OPTIMIZED=2)

If C_USE_MMU > 1 two additional cycles are added with C_AREA_OPTIMIZED=2.

Note

A delay slot must not be used by the following: imm, branch, or break instructions. Interrupts and external hardware breaks are deferred until after the delay slot branch has been completed.

blei

Figure 72: blei

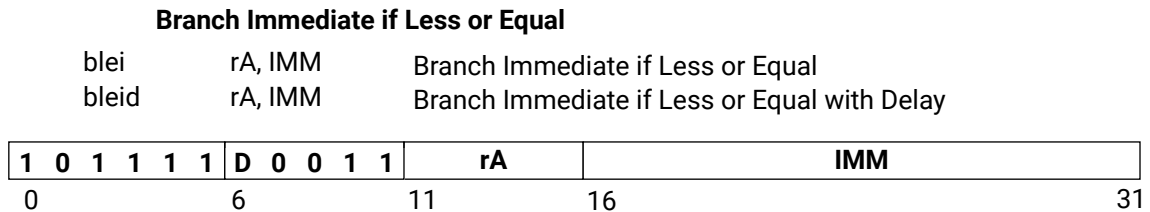

Description

Branch if rA is less or equal to 0, to the instruction located in the offset value of IMM. The target of the branch will be the instruction at address PC + IMM.

The mnemonic bleid will set the D bit. The D bit determines whether there is a branch delay slot or not. If the D bit is set, it means that there is a delay slot and the instruction following the branch (that is, in the branch delay slot) is allowed to complete execution before executing the target instruction. If the D bit is not set, it means that there is no delay slot, so the instruction to be executed after the branch is the target instruction.

Pseudocode

```

If rA <= 0 then
    PC ← PC + sext(IMM)
else
    PC ← PC + 4
if D = 1 then
    allow following instruction to complete execution
    
```

Registers Altered

- PC

Latency

- 1 cycle (if branch is not taken, or successful branch prediction occurs)
- 2 cycles (if branch is taken and the D bit is set with C_AREA_OPTIMIZED≠2)
- 3 cycles (if branch is taken and the D bit is not set with C_AREA_OPTIMIZED≠2, or a branch prediction mispredict occurs with C_AREA_OPTIMIZED=0)
- 6 cycles (if branch is taken and the D bit is set with C_AREA_OPTIMIZED=2)
- 7 cycles (if branch is taken and the D bit is not set, or if branch prediction mispredict occurs with C_AREA_OPTIMIZED=2)

If C_USE_MMU > 1 two additional cycles are added with C_AREA_OPTIMIZED=2.

Notes

- By default, Type B Instructions will take the 16-bit IMM field value and sign extend it to 32 bits to use as the immediate operand. This behavior can be overridden by preceding the Type B instruction with an imm instruction. See the instruction [imm](#) for details on using 32-bit immediate values.
- A delay slot must not be used by the following: imm, branch, or break instructions. Interrupts and external hardware breaks are deferred until after the delay slot branch has been completed.

blt

Figure 73: blt

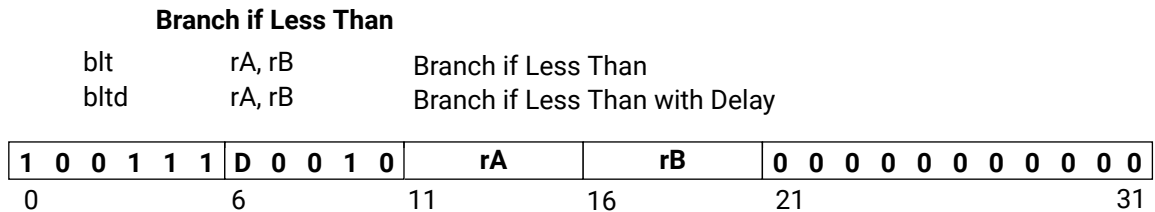

Description

Branch if rA is less than 0, to the instruction located in the offset value of rB. The target of the branch will be the instruction at address PC + rB.

The mnemonic bltd will set the D bit. The D bit determines whether there is a branch delay slot or not. If the D bit is set, it means that there is a delay slot and the instruction following the branch (that is, in the branch delay slot) is allowed to complete execution before executing the target instruction. If the D bit is not set, it means that there is no delay slot, so the instruction to be executed after the branch is the target instruction.

Pseudocode

```

If rA < 0 then
    PC ← PC + rB
else
    PC ← PC + 4
if D = 1 then
    allow following instruction to complete execution
    
```

Registers Altered

- PC

Latency

- 1 cycle (if branch is not taken)
- 2 cycles (if branch is taken and the D bit is set with C_AREA_OPTIMIZED≠2)
- 3 cycles (if branch is taken and the D bit is not set with C_AREA_OPTIMIZED≠2)
- 6 cycles (if branch is taken and the D bit is set with C_AREA_OPTIMIZED=2)
- 7 cycles (if branch is taken and the D bit is not set with C_AREA_OPTIMIZED=2)

If C_USE_MMU > 1 two additional cycles are added with C_AREA_OPTIMIZED=2.

Note

A delay slot must not be used by the following: imm, branch, or break instructions. Interrupts and external hardware breaks are deferred until after the delay slot branch has been completed.

Notes

- By default, Type B Instructions will take the 16-bit IMM field value and sign extend it to 32 bits to use as the immediate operand. This behavior can be overridden by preceding the Type B instruction with an imm instruction. See the instruction [imm](#) for details on using 32-bit immediate values.
- A delay slot must not be used by the following: imm, branch, or break instructions. Interrupts and external hardware breaks are deferred until after the delay slot branch has been completed.

Note

A delay slot must not be used by the following: imm, branch, or break instructions. Interrupts and external hardware breaks are deferred until after the delay slot branch has been completed.

bnei

Figure 76: bnei

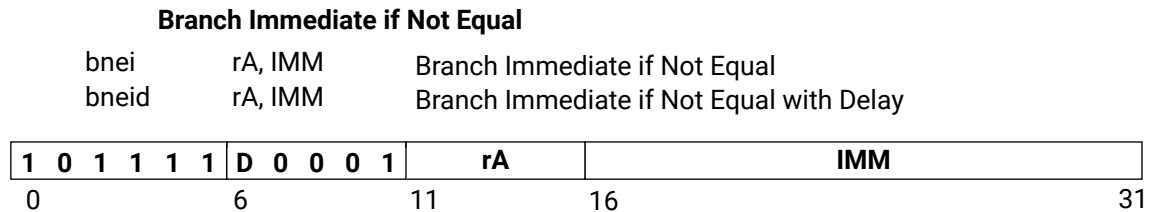

Description

Branch if rA not equal to 0, to the instruction located in the offset value of IMM. The target of the branch will be the instruction at address PC + IMM.

The mnemonic bneid will set the D bit. The D bit determines whether there is a branch delay slot or not. If the D bit is set, it means that there is a delay slot and the instruction following the branch (that is, in the branch delay slot) is allowed to complete execution before executing the target instruction. If the D bit is not set, it means that there is no delay slot, so the instruction to be executed after the branch is the target instruction.

Pseudocode

```

If rA ≠ 0 then
  PC ← PC + sext(IMM)
else
  PC ← PC + 4
if D = 1 then
  allow following instruction to complete execution
  
```

Registers Altered

- PC

Latency

- 1 cycle (if branch is not taken, or successful branch prediction occurs)
- 2 cycles (if branch is taken and the D bit is set with C_AREA_OPTIMIZED≠2)
- 3 cycles (if branch is taken and the D bit is not set with C_AREA_OPTIMIZED≠2, or a branch prediction mispredict occurs with C_AREA_OPTIMIZED=0)
- 6 cycles (if branch is taken and the D bit is set with C_AREA_OPTIMIZED=2)
- 7 cycles (if branch is taken and the D bit is not set, or if branch prediction mispredict occurs with C_AREA_OPTIMIZED=2)

If C_USE_MMU > 1 two additional cycles are added with C_AREA_OPTIMIZED=2.

Notes

- By default, Type B Instructions will take the 16-bit IMM field value and sign extend it to 32 bits to use as the immediate operand. This behavior can be overridden by preceding the Type B instruction with an `imm` instruction. See the instruction [imm](#) for details on using 32-bit immediate values.
- A delay slot must not be used by the following: `imm`, `branch`, or `break` instructions. Interrupts and external hardware breaks are deferred until after the delay slot branch has been completed.

br

Figure 77: br

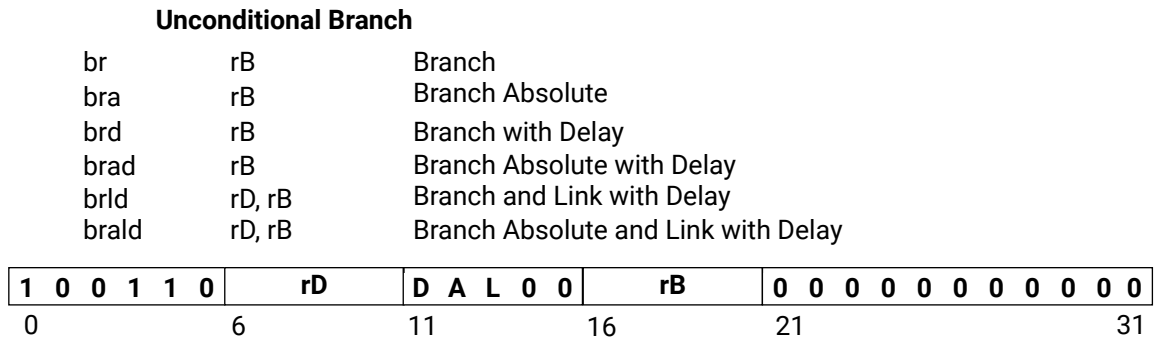

Description

Branch to the instruction located at address determined by rB.

The mnemonics brld and brald will set the L bit. If the L bit is set, linking will be performed. The current value of PC will be stored in rD.

The mnemonics bra, brad, and brald will set the A bit. If the A bit is set, it means that the branch is to an absolute value and the target is the value in rB, otherwise, it is a relative branch and the target will be PC + rB.

The mnemonics brd, brad, brld, and brald will set the D bit. The D bit determines whether there is a branch delay slot or not. If the D bit is set, it means that there is a delay slot and the instruction following the branch (that is, in the branch delay slot) is allowed to complete execution before executing the target instruction.

If the D bit is not set, it means that there is no delay slot, so the instruction to be executed after the branch is the target instruction.

Pseudocode

```

if L = 1 then
    (rD) ← PC
if A = 1 then
    PC ← (rB)
else
    PC ← PC + (rB)
if D = 1 then
    allow following instruction to complete execution
    
```

Registers Altered

- rD
- PC

Latency

- 2 cycles (if the D bit is set with `C_AREA_OPTIMIZED≠2`)
- 3 cycles (if the D bit is not set with `C_AREA_OPTIMIZED≠2`)
- 6 cycles (if the D bit is set with `C_AREA_OPTIMIZED=2`)
- 7 cycles (if the D bit is not set with `C_AREA_OPTIMIZED=2`)

If `C_USE_MMU > 1` two additional cycles are added with `C_AREA_OPTIMIZED=2`.

Notes

The instructions `brl` and `bral` are not available. A delay slot must not be used by the following: `imm`, `branch`, or `break` instructions. Interrupts and external hardware breaks are deferred until after the delay slot branch has been completed.

With 64-bit mode, the absolute branch instructions `bra`, `brad`, and `brald` use the entire 64-bit register `rBL`, `brald` uses the entire 64-bit register `rDL`, and the instructions can be used for extended address branches.

bri

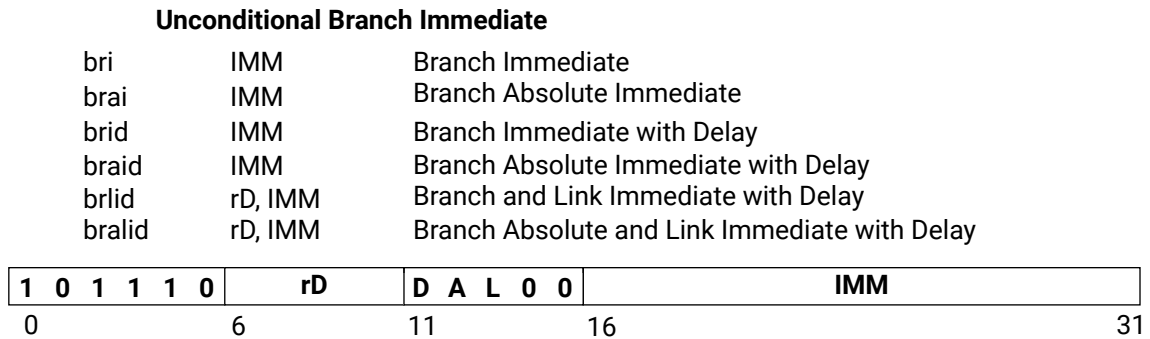
 Figure 78: **bri**

Description

Branch to the instruction located at address determined by IMM, sign-extended to 32 bits.

The mnemonics brlid and bralid will set the L bit. If the L bit is set, linking will be performed. The current value of PC will be stored in rD.

The mnemonics brai, braid, and bralid will set the A bit. If the A bit is set, it means that the branch is to an absolute value and the target is the value in IMM, otherwise, it is a relative branch and the target will be PC + IMM.

The mnemonics brid, braid, brlid, and bralid will set the D bit. The D bit determines whether there is a branch delay slot or not. If the D bit is set, it means that there is a delay slot and the instruction following the branch (that is, in the branch delay slot) is allowed to complete execution before executing the target instruction. If the D bit is not set, it means that there is no delay slot, so the instruction to be executed after the branch is the target instruction.

As a special case, when MicroBlaze is configured to use an MMU (`C_USE_MMU >= 1`) and "bralid rD, C_BASE_VECTORS+0x8" is used to perform a User Vector Exception, the Machine Status Register bits User Mode and Virtual Mode are cleared.

Pseudocode

```

if L = 1 then
    (rD) ← PC
if A = 1 then
    PC ← sext(IMM)
else
    PC ← PC + sext(IMM)
if D = 1 then
    allow following instruction to complete execution
    
```

```

if D = 1 and A = 1 and L = 1 and IMM = C_BASE_VECTORS+0x8 then
    MSR[UMS] ← MSR[UM]
    MSR[VMS] ← MSR[VM]
    MSR[UM] ← 0
    MSR[VM] ← 0

```

Registers Altered

- rD
- PC
- MSR[UM], MSR[VM]

Latency

- 1 cycle (if successful branch prediction occurs)
- 2 cycles (if the D bit is set with C_AREA_OPTIMIZED≠2)
- 3 cycles (if the D bit is not set with C_AREA_OPTIMIZED≠2, or a branch prediction mispredict occurs with C_AREA_OPTIMIZED=0)
- 6 cycles (if the D bit is set with C_AREA_OPTIMIZED=2)
- 7 cycles (if the D bit is not set, or if branch prediction mispredict occurs with C_AREA_OPTIMIZED=2)

If C_USE_MMU > 1 two additional cycles are added with C_AREA_OPTIMIZED=2.

Notes

- The instructions brli and brali are not available.
- By default, Type B Instructions will take the 16-bit IMM field value and sign extend it to use as the immediate operand. This behavior can be overridden by preceding the Type B instruction with an imm instruction. See the instruction [imm](#) for details on using immediate values.
- A delay slot must not be used by the following: imm, branch, or break instructions. Interrupts and external hardware breaks are deferred until after the delay slot branch has been completed.
- With 64-bit mode, the absolute branch instructions brai, braid, and bralid can also be preceded by an imml instruction, bralid uses the entire 64-bit registers rD_L, and the instructions can be used for extended address branches.

brk

Figure 79: brk

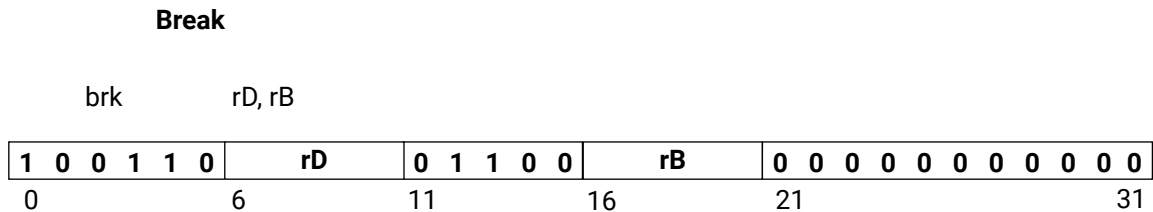

Description

Branch and link to the instruction located at address value in rB. The current value of PC will be stored in rD. The BIP flag in the MSR will be set, and the reservation bit will be cleared.

When MicroBlaze is configured to use an MMU ($C_USE_MMU \geq 1$) this instruction is privileged. This means that if the instruction is attempted in User Mode ($MSR[UM] = 1$) a Privileged Instruction exception occurs.

Pseudocode

```

if MSR[UM] = 1 then
    ESR[EC] ← 00111
else
    (rD) ← PC
    PC ← (rB)
    MSR[BIP] ← 1
    Reservation ← 0
    
```

Registers Altered

- rD
- PC
- MSR[BIP]
- ESR[EC], in case a privileged instruction exception is generated

Latency

- 3 cycles (with $C_AREA_OPTIMIZED \neq 2$)
- 7 cycles (with $C_AREA_OPTIMIZED = 2$)

If $C_USE_MMU > 1$ two additional cycles are added with $C_AREA_OPTIMIZED = 2$.

Note

With 64-bit mode, the instruction uses the entire 64-bit registers rB_L and rD_L , and can be used for extended address branches.

brki

Figure 80: brki

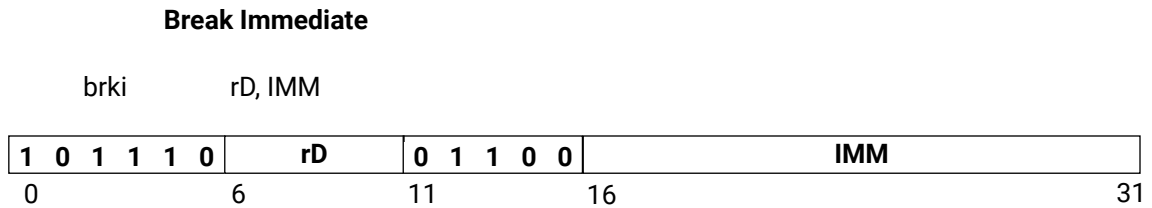

Description

Branch and link to the instruction located at address value in IMM, sign-extended to 32 bits. The current value of PC will be stored in rD. The BIP flag in the MSR will be set, except in case of a Software Break, and the reservation bit will be cleared.

When MicroBlaze is configured to use an MMU ($C_USE_MMU \geq 1$) this instruction is privileged, except as a special case when "brki rD, C_BASE_VECTORS+0x8" or "brki rD, C_BASE_VECTORS+0x18" is used to perform a Software Break. This means that, apart from the special case, if the instruction is attempted in User Mode ($MSR[UM] = 1$) a Privileged Instruction exception occurs.

As a special case, when MicroBlaze is configured to use an MMU ($C_USE_MMU \geq 1$) and "brki rD, C_BASE_VECTORS+0x8" or "brki rD, C_BASE_VECTORS+0x18" is used to perform a Software Break, the Machine Status Register bits User Mode and Virtual Mode are cleared.

Pseudocode

```

if MSR[UM] and IMM ≠ C_BASE_VECTORS+0x8 and IMM ≠ C_BASE_VECTORS+0x18 then
    ESR[EC] ← 00111
else
    (rD) ← PC
    PC ← sext(IMM)
    if IMM ≠ 0x18 then
        MSR[BIP] ← 1
        Reservation ← 0
    if IMM = C_BASE_VECTORS+0x8 or IMM = C_BASE_VECTORS+0x18 then
        MSR[UMS] ← MSR[UM]
        MSR[UM] ← 0
        MSR[VMS] ← MSR[VM]
        MSR[VM] ← 0
    
```

Registers Altered

- rD, unless an exception is generated, in which case the register is unchanged
- PC
- MSR[BIP], MSR[UM], MSR[VM]

- ESR[EC], in case a privileged instruction exception is generated

Latency

- 3 cycles (with `C_AREA_OPTIMIZED≠2`)
- 7 cycles (with `C_AREA_OPTIMIZED = 2`)

Notes

- By default, Type B Instructions will take the 16-bit IMM field value and sign extend it to use as the immediate operand. This behavior can be overridden by preceding the Type B instruction with an `imm` instruction. See the instruction [imm](#) for details on using immediate values.
- As a special case, the `imm` instruction does not override a Software Break “`brki rD, 0x18`” when `C_DEBUG_ENABLED` is greater than zero, irrespective of the value of `C_BASE_VECTORS`, to allow Software Break after an `imm` instruction.
- With 64-bit mode, the instruction can also be preceded by an `imml` instruction, uses the entire 64-bit register `rDL`, and can be used for extended address branches.

bs

Figure 81: bs

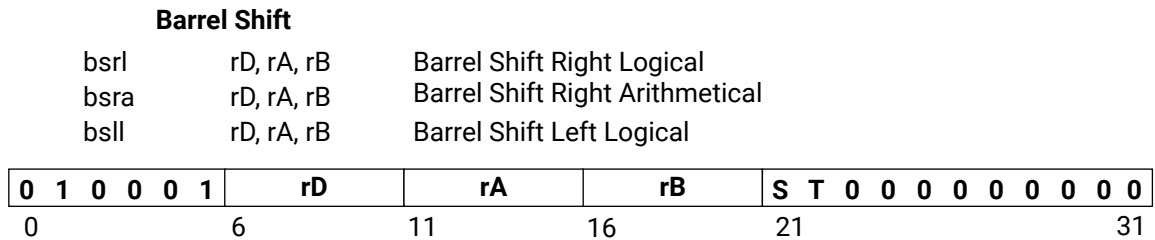

Description

Shifts the contents of register rA by the amount specified in register rB and puts the result in register rD.

The mnemonic bsll sets the S bit (Side bit). If the S bit is set, the barrel shift is done to the left. The mnemonics bsrl and bsra clear the S bit and the shift is done to the right.

The mnemonic bsra will set the T bit (Type bit). If the T bit is set, the barrel shift performed is Arithmetical. The mnemonics bsrl and bsll clear the T bit and the shift performed is Logical.

Pseudocode

```

if S = 1 then
    (rD) ← (rA) << (rB)[27:31]
else
    if T = 1 then
        if ((rB)[27:31]) ≠ 0 then
            (rD)[0:(rB)[27:31]-1] ← (rA)[0]
            (rD)[(rB)[27:31]:31] ← (rA) >> (rB)[27:31]
        else
            (rD) ← (rA)
    else
        (rD) ← (rA) >> (rB)[27:31]
    
```

Registers Altered

- rD

Latency

- 1 cycle with C_AREA_OPTIMIZED=0 or 2
- 2 cycles with C_AREA_OPTIMIZED=1

Note

These instructions are optional. To use them, MicroBlaze has to be configured to use barrel shift instructions (`C_USE_BARREL=1`).

bsi

Figure 82: bsi

Barrel Shift Immediate

bsrli	rD, rA, IMM	Barrel Shift Right Logical Immediate
bsrai	rD, rA, IMM	Barrel Shift Right Arithmetic Immediate
bslli	rD, rA, IMM	Barrel Shift Left Logical Immediate
bsefi	rD, rA, IMM _w , IMM _s	Barrel Shift Right Logical Immediate
bsifi	rD, rA, Width ¹ , IMM _s	Barrel Shift Right Arithmetic Immediate

1. Width = IMM_w-IMM_s+1

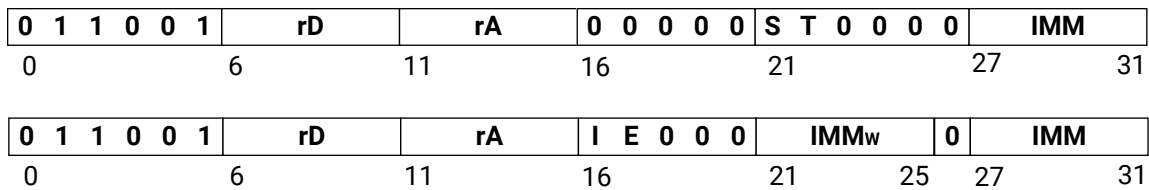

Description

The first three instructions shift the contents of register rA by the amount specified by IMM and put the result in register rD.

Barrel Shift Extract Field extracts a bit field from register rA and puts the result in register rD. The bit field width is specified by IMM_w and the shift amount is specified by IMM_s. The bit field width must be in the range 1 - 31, and the condition IMM_w + IMM_s ≤ 32 must apply.

Barrel Shift Insert Field inserts a bit field from register rA into register rD, modifying the existing value in register rD. The bit field width is defined by IMM_w - IMM_s + 1, and the shift amount is specified by IMM_s. The condition IMM_w ≥ IMM_s must apply.

The mnemonic bslli sets the S bit (Side bit). If the S bit is set, the barrel shift is done to the left. The mnemonics bsrli and bsrai clear the S bit and the shift is done to the right.

The mnemonic bsrai sets the T bit (Type bit). If the T bit is set, the barrel shift performed is Arithmetical. The mnemonics bsrli and bslli clear the T bit and the shift performed is Logical.

The mnemonic bsefi sets the E bit (Extract bit). In this case the S and T bits are not used.

The mnemonic bsifi sets the I bit (Insert bit). In this case the S and T bits are not used.

Pseudocode

```

if E = 1 then
    (rD)[0:31-IMMW] ← 0
    (rD)[32-IMMW:31] ← (rA) >> IMMS
else if I = 1 then
    mask ← (0xffffffff << (IMMW + 1)) ⊕ (0xffffffff << IMMS)
    (rD) ← ((rA) << IMMS) ∧ mask ∨ ((rD) ∧ mask)
else if S = 1 then
    (rD) ← (rA) << IMM
else if T = 1 then
    if IMM ≠ 0 then
        (rD)[0:IMM-1] ← (rA)[0]
        (rD)[IMM:31] ← (rA) >> IMM
    else
        (rD) ← (rA)
else
    (rD) ← (rA) >> IMM

```

Registers Altered

- rD

Latency

- 1 cycle with C_AREA_OPTIMIZED=0 or 2
- 2 cycles with C_AREA_OPTIMIZED=1

Notes

- These are not Type B Instructions. There is no effect from a preceding imm instruction.
- These instructions are optional. To use them, MicroBlaze has to be configured to use barrel shift instructions (C_USE_BARREL=1).
- The assembler code "bsif rD, rA, width, shift" denotes the actual bit field width, not the IMM_W field, which is computed by IMM_W = shift + width - 1.

clz

Figure 83: clz

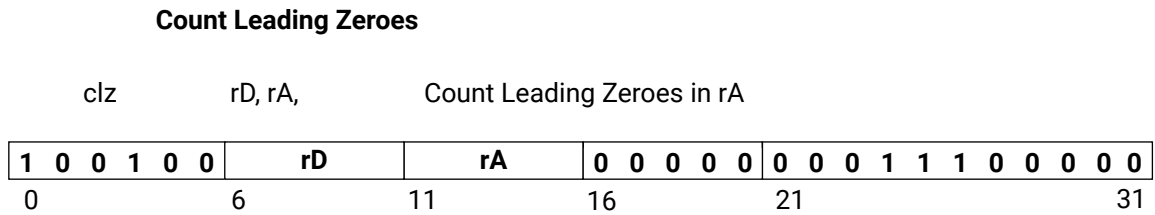

Description

This instruction counts the number of leading zeros in register rA starting from the most significant bit. The result is a number between 0 and 32, stored in register rD.

The result in rD is 32 when rA is 0, and it is 0 if rA is 0xFFFFFFFF.

Pseudocode

```

n ← 0
while (rA)[n] = 0
    n ← n + 1
(rD) ← n
    
```

Registers Altered

- rD

Latency

1 cycle

Note

This instruction is only available when the parameter C_USE_PCOMP_INSTR is set to 1.

cmp

Figure 84: cmp

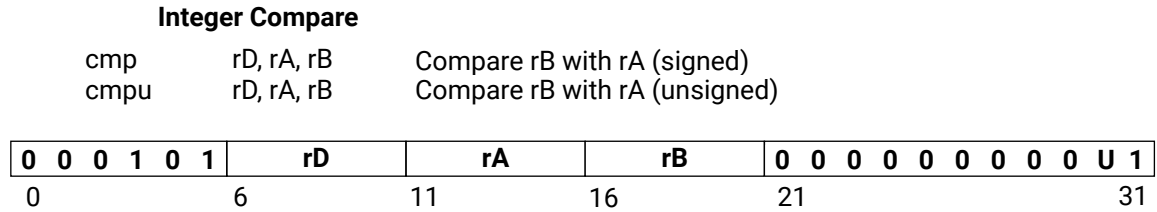

Description

The contents of register rA are subtracted from the contents of register rB and the result is placed into register rD.

The MSB bit of rD is adjusted to shown true relation between rA and rB. If the U bit is set, rA and rB is considered unsigned values. If the U bit is clear, rA and rB is considered signed values.

Pseudocode

```
(rD) ← (rB) + (rA) + 1
(rD)(MSB) ← (rA) > (rB)
```

Registers Altered

- rD

Latency

1 cycle

fadd

Figure 85: fadd

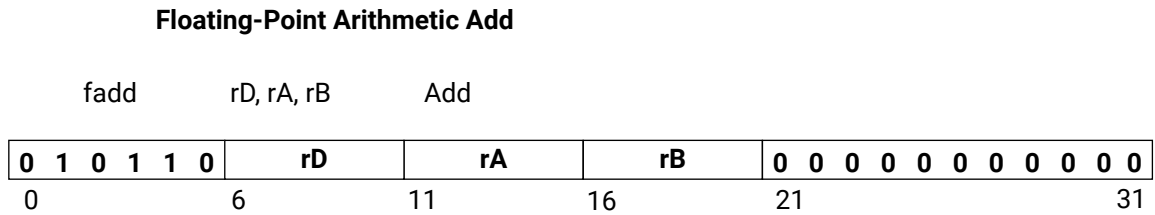

Description

The floating-point sum of registers rA and rB, is placed into register rD.

Pseudocode

```

if isDnz(rA) or isDnz(rB) then
    (rD) ← 0xFFC00000
    FSR[DO] ← 1
    ESR[EC] ← 00110
else if isSigNaN(rA) or isSigNaN(rB) or
    (isPosInfinite(rA) and isNegInfinite(rB)) or
    (isNegInfinite(rA) and isPosInfinite(rB)) then
    (rD) ← 0xFFC00000
    FSR[IO] ← 1
    ESR[EC] ← 00110
else if isQuietNaN(rA) or isQuietNaN(rB) then
    (rD) ← 0xFFC00000
else if isDnz((rA)+(rB)) then
    (rD) ← signZero((rA)+(rB))
    FSR[UF] ← 1
    ESR[EC] ← 00110
else if isNaN((rA)+(rB)) then
    (rD) ← signInfinite((rA)+(rB))
    FSR[OF] ← 1
    ESR[EC] ← 00110
else
    (rD) ← (rA) + (rB)
    
```

Registers Altered

- rD, unless an FP exception is generated, in which case the register is unchanged
- ESR[EC], if an FP exception is generated
- FSR[IO,UF,OF,DO]

Latency

- 4 cycles with C_AREA_OPTIMIZED=0
- 6 cycles with C_AREA_OPTIMIZED=1

- 1 cycle with C_AREA_OPTIMIZED=2

Note

This instruction is only available when the MicroBlaze parameter C_USE_FPU is greater than 0.

frsub

Figure 86: frsub

Reverse Floating-Point Arithmetic Subtraction

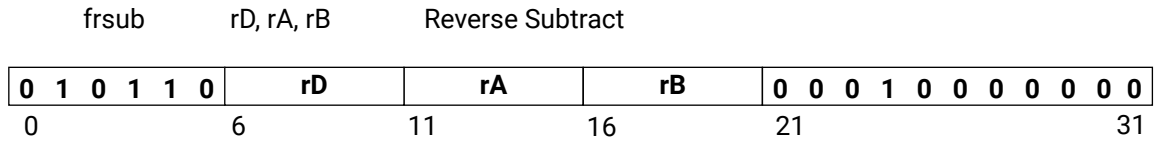

Description

The floating-point value in rA is subtracted from the floating-point value in rB and the result is placed into register rD.

Pseudocode

```

if isDnz(rA) or isDnz(rB) then
    (rD) ← 0xFFC00000
    FSR[DO] ← 1
    ESR[EC] ← 00110
else if (isSigNaN(rA) or isSigNaN(rB) or
        (isPosInfinite(rA) and isPosInfinite(rB)) or
        (isNegInfinite(rA) and isNegInfinite(rB))) then
    (rD) ← 0xFFC00000
    FSR[IO] ← 1
    ESR[EC] ← 00110
else if isQuietNaN(rA) or isQuietNaN(rB) then
    (rD) ← 0xFFC00000
else if isDnz((rB)-(rA)) then
    (rD) ← signZero((rB)-(rA))
    FSR[UF] ← 1
    ESR[EC] ← 00110
else if isNaN((rB)-(rA)) then
    (rD) ← signInfinite((rB)-(rA))
    FSR[OF] ← 1
    ESR[EC] ← 00110
else
    (rD) ← (rB) - (rA)
    
```

Registers Altered

- rD, unless an FP exception is generated, in which case the register is unchanged
- ESR[EC], if an FP exception is generated
- FSR[IO,UF,OF,DO]

Latency

- 4 cycles with C_AREA_OPTIMIZED=0

- 6 cycles with `C_AREA_OPTIMIZED=1`
- 1 cycle with `C_AREA_OPTIMIZED=2`

Note

This instruction is only available when the MicroBlaze parameter `C_USE_FPU` is greater than 0.

fmul

Figure 87: fmul

Floating-Point Arithmetic Multiplication

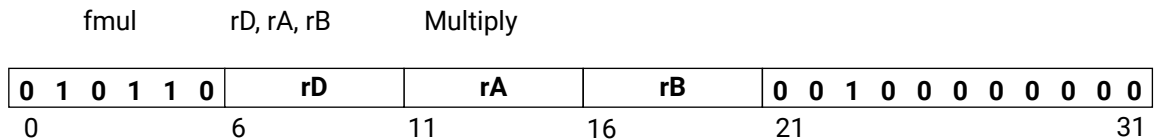

Description

The floating-point value in rA is multiplied with the floating-point value in rB and the result is placed into register rD.

Pseudocode

```

if isDnz(rA) or isDnz(rB) then
    (rD) ← 0xFFC00000
    FSR[DO] ← 1
    ESR[EC] ← 00110
else
    if isSigNaN(rA) or isSigNaN(rB) or (isZero(rA) and isInfinite(rB)) or
       (isZero(rB) and isInfinite(rA)) then
        (rD) ← 0xFFC00000
        FSR[IO] ← 1
        ESR[EC] ← 00110
    else if isQuietNaN(rA) or isQuietNaN(rB) then
        (rD) ← 0xFFC00000
    else if isDnz((rB)*(rA)) then
        (rD) ← signZero((rA)*(rB))
        FSR[UF] ← 1
        ESR[EC] ← 00110
    else if isNaN((rB)*(rA)) then
        (rD) ← signInfinite((rB)*(rA))
        FSR[OF] ← 1
        ESR[EC] ← 00110
    else
        (rD) ← (rB) * (rA)
    
```

Registers Altered

- rD, unless an FP exception is generated, in which case the register is unchanged
- ESR[EC], if an FP exception is generated
- FSR[IO,UF,OF,DO]

Latency

- 4 cycles with C_AREA_OPTIMIZED=0

- 6 cycles with `C_AREA_OPTIMIZED=1`
- 1 cycle with `C_AREA_OPTIMIZED=2`

Note

This instruction is only available when the MicroBlaze parameter `C_USE_FPU` is greater than 0.

fdiv

Figure 88: fdiv

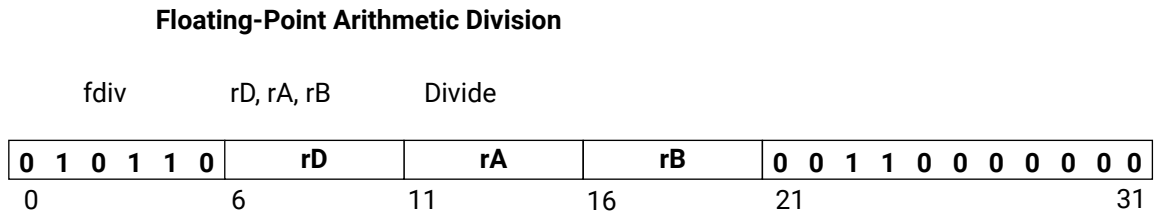

Description

The floating-point value in rB is divided by the floating-point value in rA and the result is placed into register rD.

Pseudocode

```

if isDnz(rA) or isDnz(rB) then
    (rD) ← 0xFFC00000
    FSR[DO] ← 1
    ESR[EC] ← 00110
else
    if isSigNaN(rA) or isSigNaN(rB) or (isZero(rA) and isZero(rB)) or
       (isInfinite(rA) and isInfinite(rB)) then
        (rD) ← 0xFFC00000
        FSR[IO] ← 1
        ESR[EC] ← 00110
    else if isQuietNaN(rA) or isQuietNaN(rB) then
        (rD) ← 0xFFC00000
    else if isZero(rA) and not isInfinite(rB) then
        (rD) ← signInfinite((rB)/(rA))
        FSR[DZ] ← 1
        ESR[EC] ← 00110
    else if isDnz((rB) / (rA)) then
        (rD) ← signZero((rB) / (rA))
        FSR[UF] ← 1
        ESR[EC] ← 00110
    else if isNaN((rB)/(rA)) then
        (rD) ← signInfinite((rB) / (rA))
        FSR[OF] ← 1
        ESR[EC] ← 00110
    else
        (rD) ← (rB) / (rA)
    
```

Registers Altered

- rD, unless an FP exception is generated, in which case the register is unchanged
- ESR[EC], if an FP exception is generated
- FSR[IO,UF,OF,DO,DZ]

Latency

- 28 cycles with C_AREA_OPTIMIZED=0
- 30 cycles with C_AREA_OPTIMIZED=1
- 24 cycles with C_AREA_OPTIMIZED=2

Note

This instruction is only available when the MicroBlaze parameter C_USE_FPU is greater than 0.

fcmp

Figure 89: fcmp

Floating-Point Number Comparison

fcmp.un	rD, rA, rB	Unordered floating-point comparison
fcmp.lt	rD, rA, rB	Less-than floating-point comparison
fcmp.eq	rD, rA, rB	Equal floating-point comparison
fcmp.le	rD, rA, rB	Less-or-equal floating-point comparison
fcmp.gt	rD, rA, rB	Greater-than floating-point comparison
fcmp.ne	rD, rA, rB	Not-Equal floating-point comparison
fcmp.ge	rD, rA, rB	Greater-or-Equal floating-point comparison

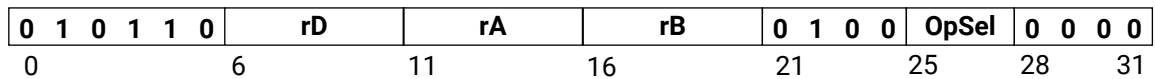

Description

The floating-point value in rB is compared with the floating-point value in rA and the comparison result is placed into register rD. The OpSel field in the instruction code determines the type of comparison performed.

Pseudocode

```

if isDnz(rA) or isDnz(rB) then
    (rD) ← 0
    FSR[DO] ← 1
    ESR[EC] ← 00110
else
    {read out behavior from Table 103}
    
```

Registers Altered

- rD, unless an FP exception is generated, in which case the register is unchanged
- ESR[EC], if an FP exception is generated
- FSR[IO,DO]

Latency

- 1 cycle with C_AREA_OPTIMIZED=0 or 2
- 3 cycles with C_AREA_OPTIMIZED=1

Note

These instructions are only available when the MicroBlaze parameter C_USE_FPU is greater than 0.

The following table lists the floating-point comparison operations.

Table 103: Floating-Point Comparison Operation

Description	OpSel	(rB) > (rA)	(rB) < (rA)	(rB) = (rA)	isSigNaN(rA) or isSigNaN(rB)	isQuietNaN(rA) or isQuietNaN(rB)
Comparison Type		Operand Relationship				
Unordered	000	(rD) ← 0	(rD) ← 0	(rD) ← 0	(rD) ← 1 FSR[IO] ← 1 ESR[EC] ← 00110	(rD) ← 1
Less-than	001	(rD) ← 0	(rD) ← 1	(rD) ← 0	(rD) ← 0 FSR[IO] ← 1 ESR[EC] ← 00110	(rD) ← 0 FSR[IO] ← 1 ESR[EC] ← 00110
Equal	010	(rD) ← 0	(rD) ← 0	(rD) ← 1	(rD) ← 0 FSR[IO] ← 1 ESR[EC] ← 00110	(rD) ← 0
Less-or-equal	011	(rD) ← 0	(rD) ← 1	(rD) ← 1	(rD) ← 0 FSR[IO] ← 1 ESR[EC] ← 00110	(rD) ← 0 FSR[IO] ← 1 ESR[EC] ← 00110
Greater-than	100	(rD) ← 1	(rD) ← 0	(rD) ← 0	(rD) ← 0 FSR[IO] ← 1 ESR[EC] ← 00110	(rD) ← 0 FSR[IO] ← 1 ESR[EC] ← 00110
Not-equal	101	(rD) ← 1	(rD) ← 1	(rD) ← 0	(rD) ← 1 FSR[IO] ← 1 ESR[EC] ← 00110	(rD) ← 1
Greater-or-equal	110	(rD) ← 1	(rD) ← 0	(rD) ← 1	(rD) ← 0 FSR[IO] ← 1 ESR[EC] ← 00110	(rD) ← 0 FSR[IO] ← 1 ESR[EC] ← 00110

flt

Figure 90: flt

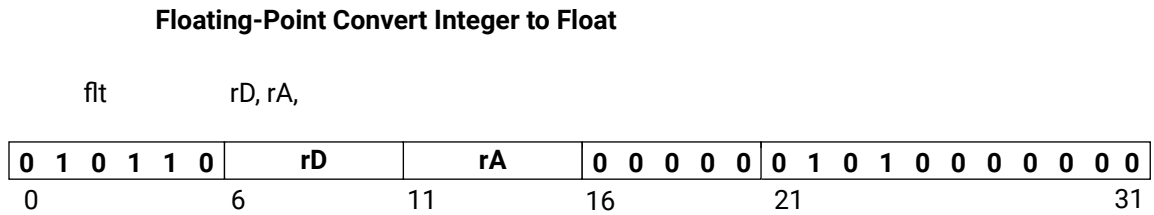

Description

Converts the signed integer in register rA to floating-point and puts the result in register rD. This is a 32-bit rounding signed conversion that will produce a 32-bit floating-point result.

Pseudocode

```
(rD) ← float ((rA))
```

Registers Altered

- rD

Latency

- 5 cycles with C_AREA_OPTIMIZED=0
- 7 cycles with C_AREA_OPTIMIZED=1
- 2 cycles with C_AREA_OPTIMIZED=2

Note

This instruction is only available when the MicroBlaze parameter C_USE_FPU is set to 2 (Extended).

Note

This instruction is only available when the MicroBlaze parameter `C_USE_FPU` is set to 2 (Extended).

fsqrt

Figure 92: fsqrt

Floating-Point Arithmetic Square Root

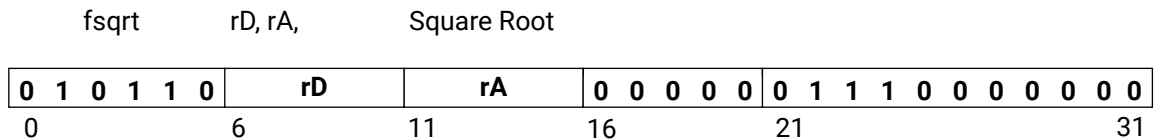

Description

Performs a floating-point square root on the value in rA and puts the result in register rD.

Pseudocode

```

if isDnz(rA) then
    (rD) ← 0xFFC00000
    FSR[DO] ← 1
    ESR[EC] ← 00110
else if isSigNaN(rA) then
    (rD) ← 0xFFC00000
    FSR[IO] ← 1
    ESR[EC] ← 00110
else if isQuietNaN(rA) then
    (rD) ← 0xFFC00000
else if (rA) < 0 then
    (rD) ← 0xFFC00000
    FSR[IO] ← 1
    ESR[EC] ← 00110
else if (rA) = -0 then
    (rD) ← -0
else
    (rD) ← sqrt ((rA))
    
```

Registers Altered

- rD, unless an FP exception is generated, in which case the register is unchanged
- ESR[EC], if an FP exception is generated
- FSR[IO,DO]

Latency

- 27 cycles with C_AREA_OPTIMIZED=0
- 29 cycles with C_AREA_OPTIMIZED=1
- 23 cycles with C_AREA_OPTIMIZED=2

Note

This instruction is only available when the MicroBlaze parameter `C_USE_FPU` is set to 2 (Extended).

get

Figure 93: get

get from stream interface

<i>tneaget</i>	rD, FSLx	get data from link x t = test only n = non-blocking e = exception if control bit set a = atomic
<i>tnecaget</i>	rD, FSLx	get control from link x t = test only n = non-blocking e = exception if control bit not set a = atomic

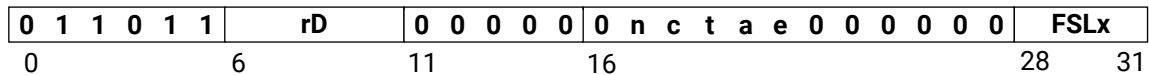

Description

MicroBlaze will read from the link x interface and place the result in register rD. If the available number of links set by `C_FSL_LINKS` is less than or equal to FSLx, the used link is undefined.

The get instruction has 32 variants.

The blocking versions (when 'n' bit is '0') will stall MicroBlaze until the data from the interface is valid. The non-blocking versions will not stall MicroBlaze and will set carry to '0' if the data was valid and to '1' if the data was invalid. In case of an invalid access the destination register contents are undefined.

All data get instructions (when 'c' bit is '0') expect the control bit from the interface to be '0'. If this is not the case, the instruction will set MSR[FSL] to '1'. All control get instructions (when 'c' bit is '1') expect the control bit from the interface to be '1'. If this is not the case, the instruction will set MSR[FSL] to '1'. The FSL bit is only set when valid data is transferred.

The exception versions (when 'e' bit is '1') will generate an exception if there is a control bit mismatch. In this case ESR is updated with EC set to the exception cause and ESS set to the link index. The target register, rD, is not updated when an exception is generated, instead the data is stored in EDR.

The test versions (when 't' bit is '1') will be handled as the normal case, except that the read signal to the link is not asserted.

Atomic versions (when 'a' bit is '1') are not interruptible. Each atomic instruction prevents the subsequent instruction from being interrupted. This means that a sequence of atomic instructions can be grouped together without an interrupt breaking the program flow. However, exceptions might still occur.

When MicroBlaze is configured to use an MMU ($C_USE_MMU \geq 1$) and not explicitly allowed by setting $C_MMU_PRIVILEGED_INSTR$ to 1 these instructions are privileged. This means that if these instructions are attempted in User Mode ($MSR[UM]=1$) a Privileged Instruction exception occurs.

Pseudocode

```

if MSR[UM] = 1 then
    ESR[EC] ← 00111
else
    x ← FSLx
    if x >= C_FSL_LINKS then
        x ← undefined
    (rD) ← Sx_AXIS_TDATA
    if (n = 1) then
        MSR[Carry] ←  $\overline{Sx\_AXIS\_TVALID}$ 
    if Sx_AXIS_TLAST ≠ c and Sx_AXIS_TVALID then
        MSR[FSL] ← 1
        if (e = 1) then
            ESR[EC] ← 00000
            ESR[ESS] ← instruction bits [28:31]
            EDR ← Sx_AXIS_TDATA

```

Registers Altered

- rD, unless an exception is generated, in which case the register is unchanged
- MSR[FSL]
- MSR[Carry]
- ESR[EC], in case a stream exception or a privileged instruction exception is generated
- ESR[ESS], in case a stream exception is generated
- EDR, in case a stream exception is generated

Latency

- 1 cycle with $C_AREA_OPTIMIZED=0$ or 2
- 2 cycles with $C_AREA_OPTIMIZED=1$

The blocking versions of this instruction will stall the pipeline of MicroBlaze until the instruction can be completed. Interrupts are served when the parameter $C_USE_EXTENDED_FSL_INSTR$ is set to 1, and the instruction is not atomic.

Notes

- To refer to an FSLx interface in assembly language, use rfsI0, rfsI1, ... rfsI15.
- The blocking versions of this instruction should not be placed in a delay slot when the parameter `C_USE_EXTENDED_FSL_INSTR` is set to 1, because this prevents interrupts from being served.
- For non-blocking versions, an rsubc instruction can be used to decrement an index variable.
- The 'e' bit does not have any effect unless `C_FSL_EXCEPTION` is set to 1.
- These instructions are only available when the MicroBlaze parameter `C_FSL_LINKS` is greater than 0.
- The extended instructions (exception, test, and atomic versions) are only available when the MicroBlaze parameter `C_USE_EXTENDED_FSL_INSTR` is set to 1.
- It is not recommended to allow these instructions in user mode, unless absolutely necessary for performance reasons, because that removes all hardware protection preventing incorrect use of a link.

getd

Figure 94: getd

get from stream interface dynamic

tneagetd rD, rB get data from link rB[28:31]
 t = test only
 n = non-blocking
 e = exception if control bit set
 a = atomic

tnecagetd rD, rB get control from link rB[28:31]
 t = test only
 n = non-blocking
 e = exception if control bit not set
 a = atomic

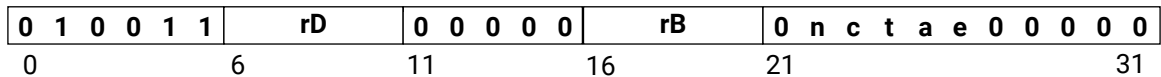

Description

MicroBlaze will read from the interface defined by the four least significant bits in rB and place the result in register rD. If the available number of links set by C_FSL_LINKS is less than or equal to the four least significant bits in rB, the used link is undefined.

The getd instruction has 32 variants.

The blocking versions (when 'n' bit is '0') will stall MicroBlaze until the data from the interface is valid. The non-blocking versions will not stall MicroBlaze and will set carry to '0' if the data was valid and to '1' if the data was invalid. In case of an invalid access the destination register contents are undefined. The FSL bit is only set when valid data is transferred.

All data get instructions (when 'c' bit is '0') expect the control bit from the interface to be '0'. If this is not the case, the instruction will set MSR[FSL] to '1'. All control get instructions (when 'c' bit is '1') expect the control bit from the interface to be '1'. If this is not the case, the instruction will set MSR[FSL] to '1'.

The exception versions (when 'e' bit is '1') will generate an exception if there is a control bit mismatch. In this case ESR is updated with EC set to the exception cause and ESS set to the link index. The target register, rD, is not updated when an exception is generated, instead the data is stored in EDR.

The test versions (when 't' bit is '1') will be handled as the normal case, except that the read signal to the link is not asserted.

Atomic versions (when 'a' bit is '1') are not interruptible. Each atomic instruction prevents the subsequent instruction from being interrupted. This means that a sequence of atomic instructions can be grouped together without an interrupt breaking the program flow. However, exceptions might still occur.

When MicroBlaze is configured to use an MMU ($C_USE_MMU \geq 1$) and not explicitly allowed by setting $C_MMU_PRIVILEGED_INSTR$ to 1 these instructions are privileged. This means that if these instructions are attempted in User Mode ($MSR[UM] = 1$) a Privileged Instruction exception occurs.

Pseudocode

```

if MSR[UM] = 1 then
    ESR[EC] ← 00111
else
    x ← rB[28:31]
    if x >= C_FSL_LINKS then
        x ← undefined
    (rD) ← Sx_AXIS_TDATA
    if (n = 1) then
        MSR[Carry] ←  $\overline{Sx\_AXIS\_TVALID}$ 
    if Sx_AXIS_TLAST ≠ c and Sx_AXIS_TVALID then
        MSR[FSL] ← 1
        if (e = 1) then
            ESR[EC] ← 00000
            ESR[ESS] ← rB[28:31]
            EDR ← Sx_AXIS_TDATA

```

Registers Altered

- rD, unless an exception is generated, in which case the register is unchanged
- MSR[FSL]
- MSR[Carry]
- ESR[EC], in case a stream exception or a privileged instruction exception is generated
- ESR[ESS], in case a stream exception is generated
- EDR, in case a stream exception is generated

Latency

- 1 cycle with $C_AREA_OPTIMIZED=0$ or 2
- 2 cycles with $C_AREA_OPTIMIZED=1$

The blocking versions of this instruction will stall the pipeline of MicroBlaze until the instruction can be completed. Interrupts are served unless the instruction is atomic, which ensures that the instruction cannot be interrupted.

Notes

- The blocking versions of this instruction should not be placed in a delay slot, because this prevents interrupts from being served.
- For non-blocking versions, an rsubc instruction can be used to decrement an index variable.
- The 'e' bit does not have any effect unless `C_FSL_EXCEPTION` is set to 1.
- These instructions are only available when the MicroBlaze parameter `C_FSL_LINKS` is greater than 0 and the parameter `C_USE_EXTENDED_FSL_INSTR` is set to 1.
- It is not recommended to allow these instructions in user mode, unless absolutely necessary for performance reasons, because that removes all hardware protection preventing incorrect use of a link.

Latency

- 1 cycle if (rA) = 0, otherwise 34 cycles with C_AREA_OPTIMIZED=0
- 1 cycle if (rA) = 0, otherwise 35 cycles with C_AREA_OPTIMIZED=1
- 1 cycle if (rA) = 0, otherwise 30 cycles with C_AREA_OPTIMIZED=2

Note

This instruction is only valid if MicroBlaze is configured to use a hardware divider (C_USE_DIV = 1).

imm

Figure 96: imm

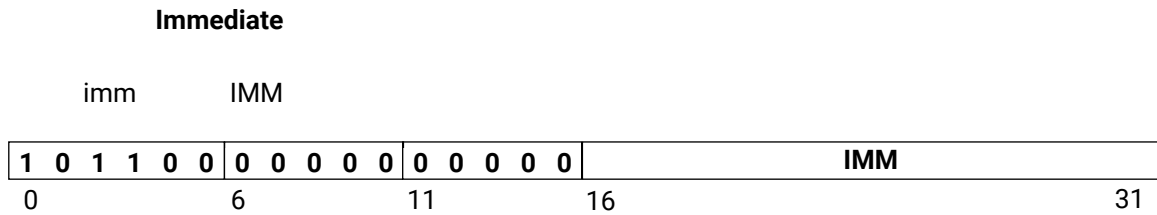

Description

The instruction `imm` loads the IMM value into a temporary register. It also locks this value so it can be used by the following instruction and form a 32-bit immediate value.

The instruction `imm` is used with Type B instructions. Because Type B instructions have only a 16-bit immediate value field, a 32-bit immediate value cannot be used directly. However, 32-bit immediate values can be used in MicroBlaze. By default, Type B Instructions will take the 16-bit IMM field value and sign extend it to 32 bits to use as the immediate operand. This behavior can be overridden by preceding the Type B instruction with an `imm` instruction. The `imm` instruction locks the 16-bit IMM value temporarily for the next instruction. A Type B instruction that immediately follows the `imm` instruction will then form a 32-bit immediate value from the 16-bit IMM value of the `imm` instruction (upper 16 bits) and its own 16-bit immediate value field (lower 16 bits). If no Type B instruction follows the `imm` instruction, the locked value gets unlocked and becomes useless.

Latency

- 1 cycle

Notes

- The `imm` instruction and the Type B instruction following it are atomic; consequently, no interrupts are allowed between them.
- The assembler automatically detects the need for `imm` instructions. When a 32-bit IMM value is specified in a Type B instruction, the assembler converts the IMM value to a 16-bit one to assemble the instruction and inserts an `imm` instruction before it in the executable file.

Registers Altered

- rD_x , unless an exception is generated, in which case the register is unchanged
- MSR[UM], MSR[VM], MSR[UMS], MSR[VMS], if an exception is generated
- ESR[EC], ESR[S], if an exception is generated
- ESR[DIZ], if a data storage exception is generated

Latency

- 1 cycle with C_AREA_OPTIMIZED=0 or 2
- 2 cycles with C_AREA_OPTIMIZED=1

Notes

- The byte reversed instruction is only valid if MicroBlaze is configured to use reorder instructions (C_USE_REORDER_INSTR = 1).
- The extended address instruction is only valid if MicroBlaze is configured to use extended address (C_ADDR_SIZE > 32) and is using 32-bit mode (C_DATA_SIZE = 32).

lbui

Figure 98: lbui

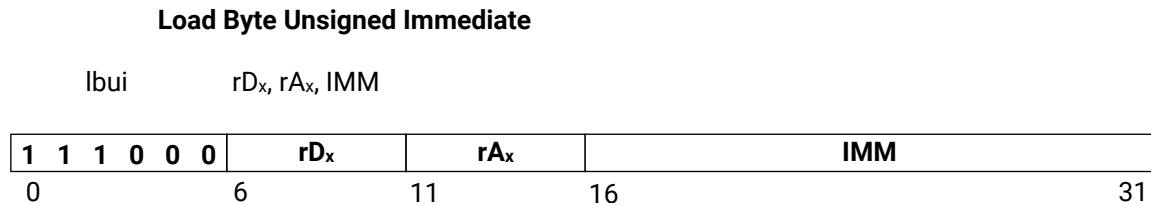

Description

Loads a byte (8 bits) from the memory location that results from adding the contents of register rA_X with the sign-extended value in IMM. The data is placed in the least significant byte of register rD_X and the other bytes in rD_X are cleared.

A data TLB miss exception occurs if virtual protected mode is enabled, and a valid translation entry corresponding to the address is not found in the TLB.

A data storage exception occurs if access is prevented by a no-access-allowed zone protection. This only applies to accesses with user mode and virtual protected mode enabled.

Pseudocode

```

Addr ← (rAx) + sext(IMM)
if TLB_Miss(Addr) and MSR[VM] = 1 then
    ESR[EC] ← 10010; ESR[S] ← 0
    MSR[UMS] ← MSR[UM]; MSR[VMS] ← MSR[VM]; MSR[UM] ← 0; MSR[VM] ← 0
else if Access_Protected(Addr) and MSR[UM] = 1 and MSR[VM] = 1 then
    ESR[EC] ← 10000; ESR[S] ← 0; ESR[DIZ] ← 1
    MSR[UMS] ← MSR[UM]; MSR[VMS] ← MSR[VM]; MSR[UM] ← 0; MSR[VM] ← 0
else
    (rDx)[C_DATA_SIZE-8:C_DATA_SIZE-1] ← Mem(Addr)
    (rDx)[0:C_DATA_SIZE-9] ← 0
    
```

Registers Altered

- rD_X, unless an exception is generated, in which case the register is unchanged
- MSR[UM], MSR[VM], MSR[UMS], MSR[VMS], if an exception is generated
- ESR[EC], ESR[S], if an exception is generated
- ESR[DIZ], if a data storage exception is generated

Latency

- 1 cycle with C_AREA_OPTIMIZED=0 or 2
- 2 cycles with C_AREA_OPTIMIZED=1

Note

By default, Type B load instructions will take the 16-bit IMM field value and sign extend it to use as the immediate operand. This behavior can be overridden by preceding the instruction with an `imm` or `imml` instruction. See the instructions [imm](#) and [imml](#) for details on using immediate values.

lhu

Figure 99: lhu

Load Halfword Unsigned

lhu	rD _x , rA _x , rB _x
lhur	rD _x , rA _x , rB _x
lhurea	rD, rA, rB

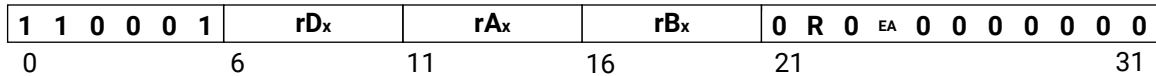

Description

Loads a halfword (16 bits) from the halfword aligned memory location that results from adding the contents of registers rA_x and rB_x. The data is placed in the least significant halfword of register rD_x and the other halfwords in rD_x is cleared.

If the R bit is set, a halfword reversed memory location is used and the two bytes in the halfword are reversed, loading data with the opposite endianness of the endianness defined by the E bit (if virtual protected mode is enabled).

If the EA bit is set, an extended address is used, formed by concatenating rA and rB instead of adding them.

A data TLB miss exception occurs if virtual protected mode is enabled, and a valid translation entry corresponding to the address is not found in the TLB.

A data storage exception occurs if access is prevented by a no-access-allowed zone protection. This only applies to accesses with user mode and virtual protected mode enabled.

An unaligned data access exception occurs if the least significant bit in the address is not zero.

A privileged instruction error occurs if the EA bit is set, Physical Address Extension (PAE) is enabled, and the instruction is not explicitly allowed.

Pseudocode

```

if EA = 1 then
    Addr ← (rA) & (rB)
else
    Addr ← (rAx) + (rBx)
if TLB_Miss(Addr) and MSR[VM] = 1 then
    ESR[EC] ← 10010; ESR[S] ← 0
    MSR[UMS] ← MSR[UM]; MSR[VMS] ← MSR[VM]; MSR[UM] ← 0; MSR[VM] ← 0
else if Access_Protected(Addr) and MSR[UM] = 1 and MSR[VM] = 1 then
    ESR[EC] ← 10000; ESR[S] ← 0 ; ESR[DIZ] ← 1
    MSR[UMS] ← MSR[UM]; MSR[VMS] ← MSR[VM]; MSR[UM] ← 0; MSR[VM] ← 0
else if Addr[31] ≠ 0 then
    ESR[EC] ← 00001; ESR[W] ← 0; ESR[S] ← 0; ESR[Rx] ← rD
else if (VM = 0 and R = 1) or
        (VM = 1 and R = 1 and E = 1) or
        (VM = 1 and R = 0 and E = 0) then
    (rDx)[C_DATA_SIZE-16:C_DATA_SIZE-9] ← Mem(Addr);
    (rDx)[C_DATA_SIZE-8:C_DATA_SIZE-1] ← Mem(Addr+1);
    (rDx)[0:C_DATA_SIZE-17] ← 0
else
    (rDx)[C_DATA_SIZE-16:C_DATA_SIZE-9] ← Mem(Addr+1);
    (rDx)[C_DATA_SIZE-8:C_DATA_SIZE-1] ← Mem(Addr);
    (rDx)[0:C_DATA_SIZE-17] ← 0

```

Registers Altered

- rD_x, unless an exception is generated, in which case the register is unchanged
- MSR[UM], MSR[VM], MSR[UMS], MSR[VMS], if an exception is generated
- ESR[EC], ESR[S], if an exception is generated
- ESR[DIZ], if a data storage exception is generated
- ESR[W], ESR[R_x], if an unaligned data access exception is generated

Latency

- 1 cycle with C_AREA_OPTIMIZED=0 or 2
- 2 cycles with C_AREA_OPTIMIZED=1

Notes

- The halfword reversed instruction is only valid if MicroBlaze is configured to use reorder instructions (C_USE_REORDER_INSTR = 1).
- The extended address instruction is only valid if MicroBlaze is configured to use extended address (C_ADDR_SIZE > 32) and is using 32-bit mode (C_DATA_SIZE = 32).

lhui

Figure 100: lhui

Load Halfword Unsigned Immediate

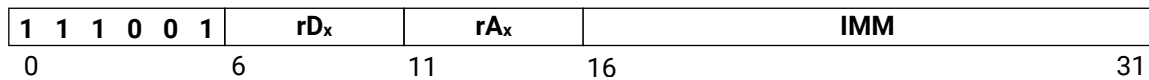
 lhui rD_x, rA_x, IMM

Description

Loads a halfword (16 bits) from the halfword aligned memory location that results from adding the contents of register rA_x and the sign-extended value in IMM. The data is placed in the least significant halfword of register rD_x and the other halfwords in rD_x is cleared.

A data TLB miss exception occurs if virtual protected mode is enabled, and a valid translation entry corresponding to the address is not found in the TLB. A data storage exception occurs if access is prevented by a no-access-allowed zone protection. This only applies to accesses with user mode and virtual protected mode enabled. An unaligned data access exception occurs if the least significant bit in the address is not zero.

Pseudocode

```

Addr ← (rAX) + sext(IMM)
if TLB_Miss(Addr) and MSR[VM] = 1 then
    ESR[EC] ← 10010; ESR[S] ← 0
    MSR[UMS] ← MSR[UM]; MSR[VMS] ← MSR[VM]; MSR[UM] ← 0; MSR[VM] ← 0
else if Access_Protected(Addr) and MSR[UM] = 1 and MSR[VM] = 1 then
    ESR[EC] ← 10000; ESR[S] ← 0; ESR[DIZ] ← 1
    MSR[UMS] ← MSR[UM]; MSR[VMS] ← MSR[VM]; MSR[UM] ← 0; MSR[VM] ← 0
else if Addr[31] ≠ 0 then
    ESR[EC] ← 00001; ESR[W] ← 0; ESR[S] ← 0; ESR[Rx] ← rD
else
    (rDX)[C_DATA_SIZE-16:C_DATA_SIZE-1] ← Mem(Addr)
    (rDX)[0:C_DATA_SIZE-17] ← 0
    
```

Registers Altered

- rD_x, unless an exception is generated, in which case the register is unchanged
- MSR[UM], MSR[VM], MSR[UMS], MSR[VMS], if a TLB miss exception or a data storage exception is generated
- ESR[EC], ESR[S], if an exception is generated
- ESR[DIZ], if a data storage exception is generated
- ESR[W], ESR[Rx], if an unaligned data access exception is generated

Latency

- 1 cycle with `C_AREA_OPTIMIZED=0` or 2
- 2 cycles with `C_AREA_OPTIMIZED=1`

Note

By default, Type B load instructions will take the 16-bit IMM field value and sign extend it to use as the immediate operand. This behavior can be overridden by preceding the instruction with an `imm` or `imml` instruction. See the instructions [imm](#) and [imml](#) for details on using immediate values.

lw

Figure 101: lw

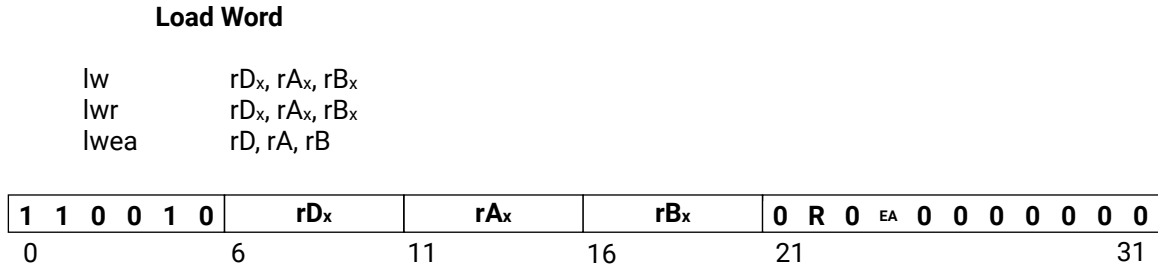

Description

Loads a word (32 bits) from the word aligned memory location that results from adding the contents of registers rA_x and rB_x. The data is placed in least significant word of register rD_x and the most significant word (if any) is cleared.

If the R bit is set, the bytes in the loaded word are reversed, loading data with the opposite endianness of the endianness defined by the E bit (if virtual protected mode is enabled).

If the EA bit is set, an extended address is used, formed by concatenating rA and rB instead of adding them.

A data TLB miss exception occurs if virtual protected mode is enabled, and a valid translation entry corresponding to the address is not found in the TLB.

A data storage exception occurs if access is prevented by a no-access-allowed zone protection. This only applies to accesses with user mode and virtual protected mode enabled.

An unaligned data access exception occurs if the two least significant bits in the address are not zero.

A privileged instruction error occurs if the EA bit is set, Physical Address Extension (PAE) is enabled, and the instruction is not explicitly allowed.

Pseudocode

```

if EA = 1 then
    Addr ← (rA) & (rB)
else
    Addr ← (rAX) + (rBX)
if TLB_Miss(Addr) and MSR[VM] = 1 then
    ESR[EC] ← 10010; ESR[S] ← 0
    MSR[UMS] ← MSR[UM]; MSR[VMS] ← MSR[VM]; MSR[UM] ← 0; MSR[VM] ← 0
else if Access_Protected(Addr) and MSR[UM] = 1 and MSR[VM] = 1 then
    ESR[EC] ← 10000; ESR[S] ← 0 ; ESR[DIZ] ← 1
    MSR[UMS] ← MSR[UM]; MSR[VMS] ← MSR[VM]; MSR[UM] ← 0; MSR[VM] ← 0
else if Addr[30:31] ≠ 0 then
    ESR[EC] ← 00001; ESR[W] ← 1; ESR[S] ← 0; ESR[Rx] ← rD
else
    (rDX[C_DATA_SIZE-32:C_DATA_SIZE-1]) ← Mem(Addr)
    (rDX[0:C_DATA_SIZE-33]) ← 0

```

Registers Altered

- rD_X, unless an exception is generated, in which case the register is unchanged
- MSR[UM], MSR[VM], MSR[UMS], MSR[VMS], if a TLB miss exception or a data storage exception is generated
- ESR[EC], ESR[S], if an exception is generated
- ESR[DIZ], if a data storage exception is generated
- ESR[W], ESR[R_x], if an unaligned data access exception is generated

Latency

- 1 cycle with C_AREA_OPTIMIZED=0 or 2
- 2 cycles with C_AREA_OPTIMIZED=1

Notes

- The word reversed instruction is only valid if MicroBlaze is configured to use reorder instructions (C_USE_REORDER_INSTR = 1).
- The extended address instruction is only valid if MicroBlaze is configured to use extended address (C_ADDR_SIZE > 32) and is using 32-bit mode (C_DATA_SIZE = 32).

lwi

Figure 102: lwi

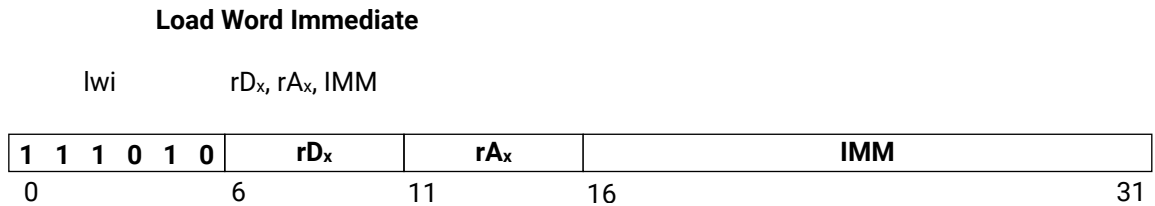

Description

Loads a word (32 bits) from the word aligned memory location that results from adding the contents of register rA_x and the sign-extended value IMM. The data is placed in the least significant word of register rD_x and the most significant word (if any) is cleared.

A data TLB miss exception occurs if virtual protected mode is enabled, and a valid translation entry corresponding to the address is not found in the TLB.

A data storage exception occurs if access is prevented by a no-access-allowed zone protection. This only applies to accesses with user mode and virtual protected mode enabled.

An unaligned data access exception occurs if the two least significant bits in the address are not zero.

Pseudocode

```

Addr ← (rAx) + sext(IMM)
if TLB_Miss(Addr) and MSR[VM] = 1 then
    ESR[EC] ← 10010; ESR[S] ← 0
    MSR[UMS] ← MSR[UM]; MSR[VMS] ← MSR[VM]; MSR[UM] ← 0; MSR[VM] ← 0
else if Access_Protected(Addr) and MSR[UM] = 1 and MSR[VM] = 1 then
    ESR[EC] ← 10000; ESR[S] ← 0 ; ESR[DIZ] ← 1
    MSR[UMS] ← MSR[UM]; MSR[VMS] ← MSR[VM]; MSR[UM] ← 0; MSR[VM] ← 0
else if Addr[30:31] ≠ 0 then
    ESR[EC] ← 00001; ESR[W] ← 1; ESR[S] ← 0 ; ESR[Rx] ← rD
else
    (rDx[C_DATA_SIZE-32:C_DATA_SIZE-1]) ← Mem(Addr); (rDx[0:C_DATA_SIZE-33])
    ← 0
    
```

Registers Altered

- rD_x, unless an exception is generated, in which case the register is unchanged
- MSR[UM], MSR[VM], MSR[UMS], MSR[VMS], if a TLB miss exception or a data storage exception is generated
- ESR[EC], ESR[S], if an exception is generated
- ESR[DIZ], if a data storage exception is generated

- ESR[W], ESR[Rx], if an unaligned data access exception is generated

Latency

- 1 cycle with C_AREA_OPTIMIZED=0 or 2
- 2 cycles with C_AREA_OPTIMIZED=1

Note

By default, Type B load instructions will take the 16-bit IMM field value and sign extend it to use as the immediate operand. This behavior can be overridden by preceding the instruction with an `imm` or `imml` instruction. See the instructions [imm](#) and [imml](#) for details on using immediate values.

lwx

Figure 103: lwx

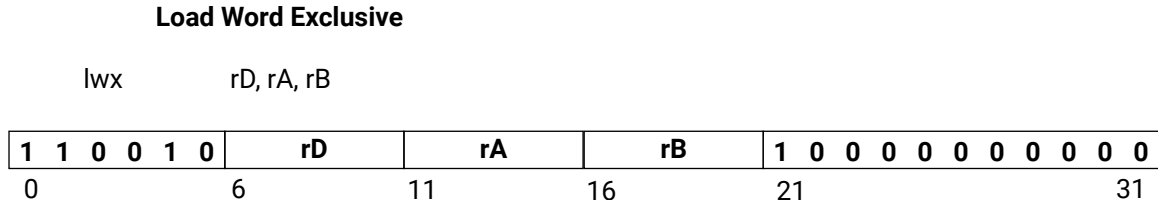

Description

Loads a word (32 bits) from the word aligned memory location that results from adding the contents of registers rA and rB. The data is placed in register rD, and the reservation bit is set. If an AXI4 interconnect with exclusive access enabled is used, and the interconnect response is not EXOKAY, the carry flag (MSR[C]) is set; otherwise the carry flag is cleared.

A data TLB miss exception occurs if virtual protected mode is enabled, and a valid translation entry corresponding to the address is not found in the TLB.

A data storage exception occurs if access is prevented by a no-access-allowed zone protection. This only applies to accesses with user mode and virtual protected mode enabled.

An unaligned data access exception will not occur, even if the two least significant bits in the address are not zero.

A data bus exception can occur when an AXI4 interconnect with exclusive access enabled is used, and the interconnect response is not EXOKAY, which means that an exclusive access cannot be handled.

Enabling AXI exclusive access ensures that the operation is protected from other bus masters, but requires that the addressed slave supports exclusive access. When exclusive access is not enabled, only the internal reservation bit is used. Exclusive access is enabled using the two parameters `C_M_AXI_DP_EXCLUSIVE_ACCESS` and `C_M_AXI_DC_EXCLUSIVE_ACCESS` for the peripheral and cache interconnect, respectively.

Pseudocode

```

Addr ← (rA) + (rB)
if TLB_Miss(Addr) and MSR[VM] = 1 then
    ESR[EC] ← 10010; ESR[S] ← 0
    MSR[UMS] ← MSR[UM]; MSR[VMS] ← MSR[VM]; MSR[UM] ← 0; MSR[VM] ← 0
else if Access_Protected(Addr) and MSR[UM] = 1 and MSR[VM] = 1 then
    ESR[EC] ← 10000; ESR[S] ← 0 ; ESR[DIZ] ← 1
    MSR[UMS] ← MSR[UM]; MSR[VMS] ← MSR[VM]; MSR[UM] ← 0; MSR[VM] ← 0
else if AXI_Exclusive(Addr) and AXI_Response = EXOKAY and MSR[EE] then
    ESR[EC] ← 00100; ESR[ECC] ← 0 ;
    MSR[UMS] ← MSR[UM]; MSR[VMS] ← MSR[VM]; MSR[UM] ← 0; MSR[VM] ← 0
else
    (rD) ← Mem(Addr); Reservation ← 1;
    if AXI_Exclusive(Addr) and AXI_Response ≠ EXOKAY then
        MSR[C] ← 1
    else
        MSR[C] ← 0

```

Registers Altered

- rD and MSR[C], unless an exception is generated, in which case they are unchanged
- MSR[UM], MSR[VM], MSR[UMS], MSR[VMS], if a TLB miss exception or a data storage exception is generated
- ESR[EC], ESR[S], if an exception is generated
- ESR[DIZ], if a data storage exception is generated

Latency

- 1 cycle with C_AREA_OPTIMIZED=0 or 2
- 2 cycles with C_AREA_OPTIMIZED=1

Notes

- This instruction is used together with SWX to implement exclusive access, such as semaphores and spinlocks.
- The carry flag (MSR[C]) might not be set immediately (dependent on pipeline stall behavior). The LWX instruction should not be immediately followed by an MSRCLR, MSRSET, MTS, or SRC instruction, to ensure the correct value of the carry flag is obtained.

mbar

Figure 104: mbar

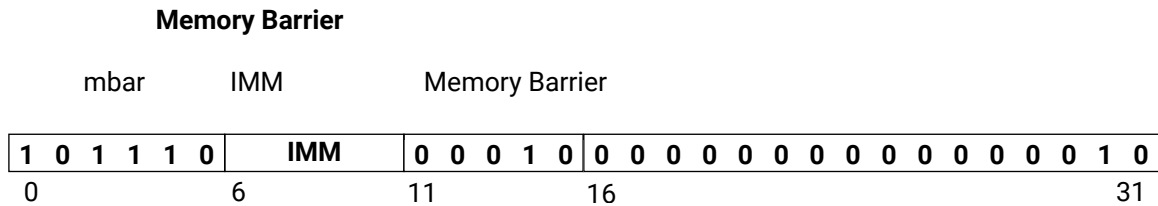

Description

This instruction ensures that outstanding memory accesses on memory interfaces are completed before any subsequent instructions are executed. This is necessary to guarantee that self-modifying code is handled correctly, and that a DMA transfer can be safely started.

With self-modifying code, it is necessary to first use an MBAR instruction to wait for data accesses, which can be done by setting IMM to 1, and then use another MBAR instruction to clear the Branch Target Cache and empty the instruction prefetch buffer, which can be done by setting IMM to 2.

To ensure that data to be read by a DMA unit has been written to memory, it is only necessary to wait for data accesses, which can be done by setting IMM to 1.

When MicroBlaze is configured to use an MMU ($C_USE_MMU \geq 1$) this instruction is privileged when the most significant bit in IMM is set to 1. This means that if the instruction is attempted in User Mode ($MSR[UM] = 1$) a Privileged Instruction exception occurs.

When the two most significant bits in IMM are set to 10 (Sleep), 01 (Hibernate), or 11 (Suspend) and no exception occurs, MicroBlaze enters sleep mode after all outstanding accesses are complete, and sets the `Sleep`, `Hibernate`, or `Suspend` output signal respectively to indicate this. The pipeline is halted, and MicroBlaze will not continue execution until a bit in the Wakeup input signal is asserted.

Pseudocode

```

if (IMM & 1) = 0 then
    wait for instruction side memory accesses
if (IMM & 2) = 0 then
    wait for data side memory accesses
PC ← PC + 4
if (IMM & 24) ≠ 0 then
    enter sleep mode
    
```

Registers Altered

- PC

- ESR[EC], in case a privileged instruction exception is generated

Latency

- $2 + N$ cycles when $C_INTERCONNECT = 2$ (AXI)
- $8 + N$ cycles when $C_INTERCONNECT = 3$ (ACE)

N is the number of cycles to wait for memory accesses to complete.

Notes

- This instruction must not be preceded by an imm instruction, and must not be placed in a delay slot.
- The assembler pseudo-instructions sleep, hibernate, and suspend can be used instead of “mbar 16”, “mbar 8”, and “mbar 24” respectively to enter sleep mode.

mfs

Figure 105: mfs

Move From Special Purpose Register

mfs rD, rS
 mfse rD, rS

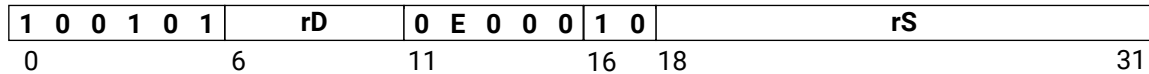

Description

Copies the contents of the special purpose register rS into register rD. The special purpose registers TLBLO and TLBHI are used to copy the contents of the Unified TLB entry indexed by TLBX.

If the E bit is set, the extended part of the special register is moved. The EAR, PVR[8] and PVR[9] registers have extended parts when extended addressing is enabled ($C_ADDR_SIZE > 32$), and the TLBLO, PVR[6] and PVR[7] registers have extended parts when Physical Address Extension (PAE) is enabled.

Pseudocode

```

if E = 1 then
    switch (rS):
        case 0x0003 : (rD) ← EAR [0:C_ADDR_SIZE-32-1]
        case 0x1003 : (rD) ← TLBLO[0:C_ADDR_SIZE-32-1]
        case 0x2006 : (rD) ← PVR6[0:C_ADDR_SIZE-32-1]
        case 0x2007 : (rD) ← PVR7[0:C_ADDR_SIZE-32-1]
        case 0x2008 : (rD) ← PVR8[0:C_ADDR_SIZE-32-1]
        case 0x2009 : (rD) ← PVR9[0:C_ADDR_SIZE-32-1]
        default : (rD) ← Undefined
else
    switch (rS):
        case 0x0000 : (rD) ← PC
        case 0x0001 : (rD) ← MSR
        case 0x0003 : (rD) ← EAR[C_ADDR_SIZE-32:C_ADDR_SIZE-1]
        case 0x0005 : (rD) ← ESR
        case 0x0007 : (rD) ← FSR
        case 0x000B : (rD) ← BTR
        case 0x000D : (rD) ← EDR
        case 0x0800 : (rD) ← SLR
        case 0x0802 : (rD) ← SHR
        case 0x1000 : (rD) ← PID
        case 0x1001 : (rD) ← ZPR
        case 0x1002 : (rD) ← TLBX
        case 0x1003 : (rD) ← TLBLO[C_ADDR_SIZE-32:C_ADDR_SIZE-1]
        case 0x1004 : (rD) ← TLBHI
        case 0x200x : (rD) ← PVRx[C_ADDR_SIZE-32:C_ADDR_SIZE-1] (x = 0 to 12)
        default : (rD) ← Undefined
    
```

Registers Altered

- rD

Latency

- 1 cycle

Notes

- To refer to special purpose registers in assembly language, use `rpc` for PC, `rmsr` for MSR, `rear` for EAR, `resr` for ESR, `rfsr` for FSR, `rbtr` for BTR, `redr` for EDR, `rslr` for SLR, `rshr` for SHR, `rpil` for PID, `rzpr` for ZPR, `rtlblo` for TLBLO, `rtlbhi` for TLBHI, `rtlbx` for TLBX, and `rpvr0` - `rpvr12` for PVR0 - PVR12.
- The value read from MSR might not include effects of the immediately preceding instruction (dependent on pipeline stall behavior). An instruction that does not affect MSR must precede the MFS instruction to guarantee correct MSR value.
- The value read from FSR might not include effects of the immediately preceding instruction (dependent on pipeline stall behavior). An instruction that does not affect FSR must precede the MFS instruction to guarantee correct FSR value.
- EAR, ESR, and BTR are only valid as operands when at least one of the MicroBlaze `C_*_EXCEPTION` parameters are set to 1.
- EDR is only valid as operand when the parameter `C_FSL_EXCEPTION` is set to 1 and the parameter `C_FSL_LINKS` is greater than 0.
- FSR is only valid as an operand when the `C_USE_FPU` parameter is greater than 0.
- SLR and SHR are only valid as an operand when the `C_USE_STACK_PROTECTION` parameter is set to 1.
- PID, ZPR, TLBLO, and TLBHI are only valid as operands when the parameter `C_USE_MMU > 1` (User Mode) and the parameter `C_MMU_TLB_ACCESS = 1` (Read) or 3 (Full).
- TLBX is only valid as operand when the parameter `C_USE_MMU > 1` (User Mode) and the parameter `C_MMU_TLB_ACCESS > 0` (Minimal).
- PVR0 is only valid as an operand when `C_PVR` is 1 (Basic) or 2 (Full), and PVR1 - PVR12 are only valid as operands when `C_PVR` is set to 2 (Full).
- The extended instruction is only valid if MicroBlaze is configured to use extended address (`C_ADDR_SIZE > 32`).

msrclr

Figure 106: msrclr

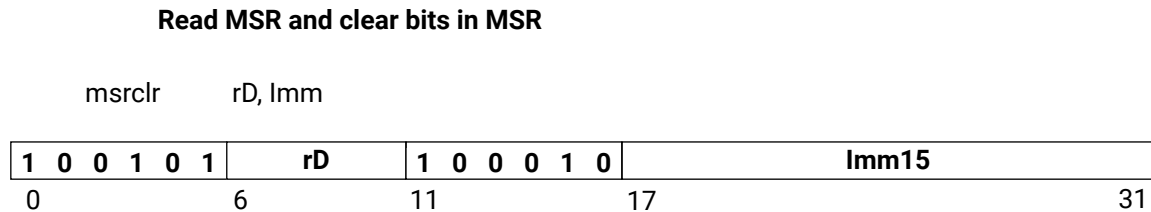

Description

Copies the contents of the special purpose register MSR into register rD. Bit positions in the IMM value that are 1 are cleared in the MSR. Bit positions that are 0 in the IMM value are left untouched.

When MicroBlaze is configured to use an MMU ($C_USE_MMU \geq 1$) this instruction is privileged for all IMM values except those only affecting C. This means that if the instruction is attempted in User Mode ($MSR[UM] = 1$) in this case a Privileged Instruction exception occurs.

Pseudocode

```

if MSR[UM] = 1 and IMM ≠ 0x4 then
    ESR[EC] ← 00111
else
    (rD) ← (MSR)
    (MSR) ← (MSR) ∧ (IMM)
    
```

Registers Altered

- rD
- MSR
- ESR[EC], in case a privileged instruction exception is generated

Latency

- 1 cycle

Notes

- MSRCLR will affect the Carry bit immediately while the remaining bits will take effect one cycle after the instruction has been executed. When clearing the IE bit, it is guaranteed that the processor will not react to any interrupt for the subsequent instructions.

- The value read from MSR might not include effects of the immediately preceding instruction (dependent on pipeline stall behavior). An instruction that does not affect MSR must precede the MSRCLR instruction to guarantee correct MSR value. This applies to both the value copied to register rD and the changed MSR value itself.
- The immediate values has to be less than 215 when C_USE_MMU >= 1 (User Mode), and less than 214 otherwise. Only bits 17 to 31 of the MSR can be cleared when C_USE_MMU >= 1 (User Mode), and bits 18 to 31 otherwise.
- This instruction is only available when the parameter C_USE_MSR_INSTR is set to 1.
- When clearing MSR[VM] the instruction must always be followed by a synchronizing branch instruction, for example BRI 4.

msrset

Figure 107: **msrset**

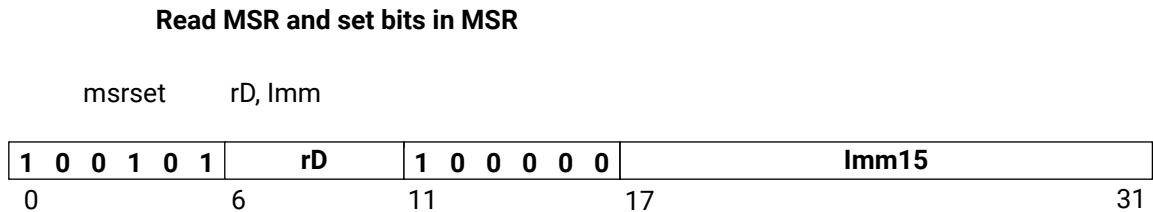

Description

Copies the contents of the special purpose register MSR into register rD. Bit positions in the IMM value that are 1 are set in the MSR. Bit positions that are 0 in the IMM value are left untouched.

When MicroBlaze is configured to use an MMU ($C_USE_MMU \geq 1$) this instruction is privileged for all IMM values except those only affecting C. This means that if the instruction is attempted in User Mode ($= 1$) in this case a Privileged Instruction exception occurs.

With low-latency interrupt mode ($C_USE_INTERRUPT = 2$), the Interrupt_Ack output port is set to 11 if the MSR{IE} bit is set by executing this instruction.

Pseudocode

```

if MSR[UM] = 1 and IMM ≠ 0x4 then
    ESR[EC] ← 00111
else
    (rD) ← (MSR)
    (MSR) ← (MSR) ∨ (IMM)
    if (IMM) & 2
        Interrupt_Ack ← 11
    
```

Registers Altered

- rD
- MSR
- ESR[EC], in case a privileged instruction exception is generated

Latency

- 1 cycle

Notes

- MSRSET will affect the Carry bit immediately while the remaining bits will take effect one cycle after the instruction has been executed. When setting the EIP or BIP bit, it is guaranteed that the processor will not react to any interrupt or normal hardware break for the subsequent instructions.
- The value read from MSR might not include effects of the immediately preceding instruction (dependent on pipeline stall behavior). An instruction that does not affect MSR must precede the MSRSET instruction to guarantee correct MSR value. This applies to both the value copied to register rD and the changed MSR value itself.
- The immediate values has to be less than 215 when `C_USE_MMU >= 1` (User Mode), and less than 214 otherwise. Only bits 17 to 31 of the MSR can be set when `C_USE_MMU >= 1` (User Mode), and bits 18 to 31 otherwise.
- This instruction is only available when the parameter `C_USE_MSR_INSTR` is set to 1.
- When setting MSR[VM] the instruction must always be followed by a synchronizing branch instruction, for example BRI 4.

mts

Figure 108: mts

Move to Special Purpose Register

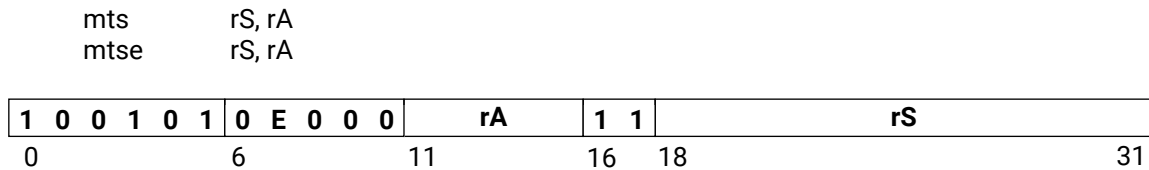

Description

Copies the contents of register rD into the special purpose register rS. The special purpose registers TLBLO and TLBHI are used to copy to the Unified TLB entry indexed by TLBX.

If the E bit is set, the extended part of the special register is moved. The TLBLO register has an extended part when the Physical Address Extension (PAE) is enabled.

When MicroBlaze is configured to use an MMU (C_USE_MMU >= 1) this instruction is privileged. This means that if the instruction is attempted in User Mode (MSR[UM] = 1) a Privileged Instruction exception occurs.

With low-latency interrupt mode (C_USE_INTERRUPT = 2), the Interrupt_Ack output port is set to 11 if the MSR{IE} bit is set by executing this instruction.

Pseudocode

```

if MSR[UM] = 1 then
    ESR[EC] ← 00111
else
    if E = 1 then
        if (rS) = 0x1003 then
            TLBLO[0:C_ADDR_SIZE-32-1] ← (rA)
        else
            switch (rS)
            case 0x0001 : MSR ← (rA)
            case 0x0007 : FSR ← (rA)
            case 0x0800 : SLR ← (rA)
            case 0x0802 : SHR ← (rA)
            case 0x1000 : PID ← (rA)
            case 0x1001 : ZPR ← (rA)
            case 0x1002 : TLBX ← (rA)
            case 0x1003 : TLBLO[C_ADDR_SIZE-32:C_ADDR_SIZE-1] ← (rA)
            case 0x1004 : TLBHI ← (rA)
            case 0x1005 : TLBSX ← (rA)
            if (rS) = 0x0001 and (rA) & 2
                Interrupt_Ack ← 11

```

Registers Altered

- rS
- ESR[EC], in case a privileged instruction exception is generated

Latency

- 1 cycle

Notes

- When writing MSR using MTS, all bits take effect one cycle after the instruction has been executed. An MTS instruction writing MSR should never be followed back-to-back by an instruction that uses the MSR content. When clearing the IE bit, it is guaranteed that the processor will not react to any interrupt for the subsequent instructions. When setting the EIP or BIP bit, it is guaranteed that the processor will not react to any interrupt or normal hardware break for the subsequent instructions.
- To refer to special purpose registers in assembly language, use rmsr for MSR, rfsr for FSR, rslr for SLR, rshr for SHR, rpid for PID, rzpr for ZPR, rtlblo for TLBLO, rtlbhi for TLBHI, rtlbx for TLBX, and rtlbsx for TLBSX.
- The PC, ESR, EAR, BTR, EDR, and PVR0 - PVR12 cannot be written by the MTS instruction.
- The FSR is only valid as a destination if the MicroBlaze parameter `C_USE_FPU` is greater than 0.
- The SLR and SHR are only valid as a destination if the MicroBlaze parameter `C_USE_STACK_PROTECTION` is set to 1.
- PID, ZPR and, TLBSX are only valid as destinations when the parameter `C_USE_MMU > 1` (User Mode) and the parameter `C_MMU_TLB_ACCESS > 1` (Read). TLBLO, TLBHI, and TLBX are only valid as destinations when the parameter `C_USE_MMU > 1` (User Mode).
- When changing MSR[VM] or PID the instruction must always be followed by a synchronizing branch instruction, for example BRI 4.
- After writing to TLBHI to invalidate one or more UTLB entries, an MBAR 1 instruction must be issued to ensure that coherency is preserved in a coherent multi-processor system.
- When PAE is enabled, the entire TLBLO register must be written, by first using the extended instruction to write the most significant bits immediately followed by the least significant bits.
- The extended instruction is only valid if MicroBlaze is configured to use the MMU in virtual mode (`C_USE_MMU = 3`) and extended address (`C_ADDR_SIZE > 32`).

mulh

Figure 110: mulh

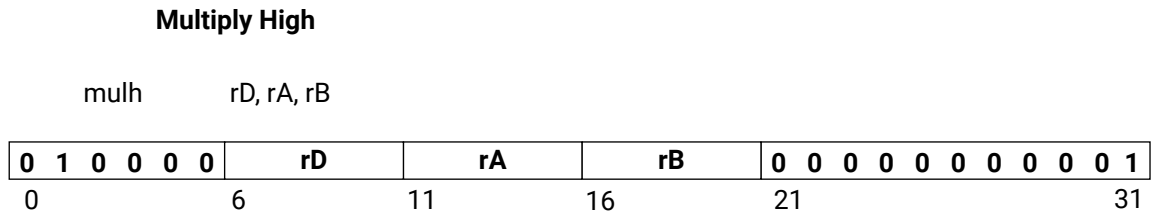

Description

Multiplies the contents of registers rA and rB and puts the result in register rD. This is a 32-bit by 32-bit signed multiplication that will produce a 64-bit result. The most significant word of this value is placed in rD. The least significant word is discarded.

Pseudocode

```
(rD) ← MSW( (rA) × (rB) ), signed
```

Registers Altered

- rD

Latency

- 1 cycle with C_AREA_OPTIMIZED=0 or 2
- 3 cycles with C_AREA_OPTIMIZED=1

Notes

- This instruction is only valid if the target architecture has multiplier primitives, and if present, the MicroBlaze parameter C_USE_HW_MUL is set to 2 (Mul64).
- When MULH is used, bit 30 and 31 in the MUL instruction must be zero to distinguish between the two instructions. In previous versions of MicroBlaze, these bits were defined as zero, but the actual values were not relevant.

mulhu

Figure 111: mulhu

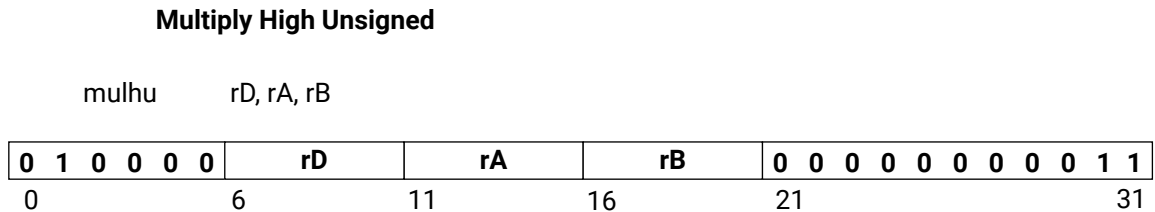

Description

Multiplies the contents of registers rA and rB and puts the result in register rD. This is a 32-bit by 32-bit unsigned multiplication that will produce a 64-bit unsigned result. The most significant word of this value is placed in rD. The least significant word is discarded.

Pseudocode

```
(rD) ← MSW( (rA) × (rB) ), unsigned
```

Registers Altered

- rD

Latency

- 1 cycle with C_AREA_OPTIMIZED=0 or 2
- 3 cycles with C_AREA_OPTIMIZED=1

Notes

- This instruction is only valid if the target architecture has multiplier primitives, and if present, the MicroBlaze parameter C_USE_HW_MUL is set to 2 (Mul64).
- When MULHU is used, bit 30 and 31 in the MUL instruction must be zero to distinguish between the two instructions. In previous versions of MicroBlaze, these bits were defined as zero, but the actual values were not relevant.

mulhsu

Figure 112: mulhsu



Description

Multiplies the contents of registers rA and rB and puts the result in register rD. This is a 32-bit signed by 32-bit unsigned multiplication that will produce a 64-bit signed result. The most significant word of this value is placed in rD. The least significant word is discarded.

Pseudocode

```
(rD) ← MSW( (rA), signed × (rB), unsigned ), signed
```

Registers Altered

- rD

Latency

- 1 cycle with C_AREA_OPTIMIZED=0 or 2
- 3 cycles with C_AREA_OPTIMIZED=1

Notes

- This instruction is only valid if the target architecture has multiplier primitives, and if present, the MicroBlaze parameter C_USE_HW_MUL is set to 2 (Mul64).
- When MULHSU is used, bit 30 and 31 in the MUL instruction must be zero to distinguish between the two instructions. In previous versions of MicroBlaze, these bits were defined as zero, but the actual values were not relevant.

multi

Figure 113: multi

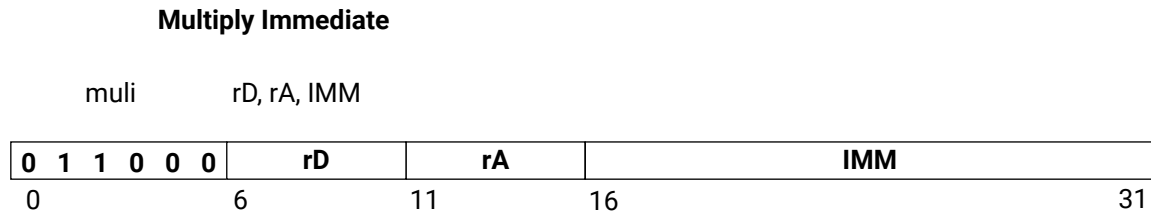

Description

Multiplies the contents of registers rA and the value IMM, sign-extended to 32 bits; and puts the result in register rD. This is a 32-bit by 32-bit multiplication that will produce a 64-bit result. The least significant word of this value is placed in rD. The most significant word is discarded.

Pseudocode

```
(rD) ← LSW( (rA) × sext(IMM) )
```

Registers Altered

- rD

Latency

- 1 cycle with C_AREA_OPTIMIZED=0 or 2
- 3 cycles with C_AREA_OPTIMIZED=1

Notes

- By default, Type B Instructions will take the 16-bit IMM field value and sign extend it to 32 bits to use as the immediate operand. This behavior can be overridden by preceding the Type B instruction with an imm instruction. See the instruction [imm](#) for details on using 32-bit immediate values.
- This instruction is only valid if the target architecture has multiplier primitives, and if present, the MicroBlaze parameter C_USE_HW_MUL is greater than 0.

or

Figure 114: **or**

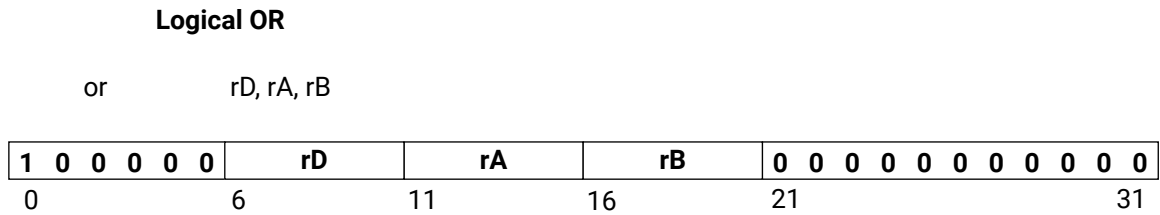

Description

The contents of register rA are ORed with the contents of register rB; the result is placed into register rD.

Pseudocode

```
rD) ← (rA) ∨ (rB)
```

Registers Altered

- rD

Latency

- 1 cycle

Note

- The assembler pseudo-instruction nop is implemented as "or r0, r0, r0".

ori

Figure 115: ori

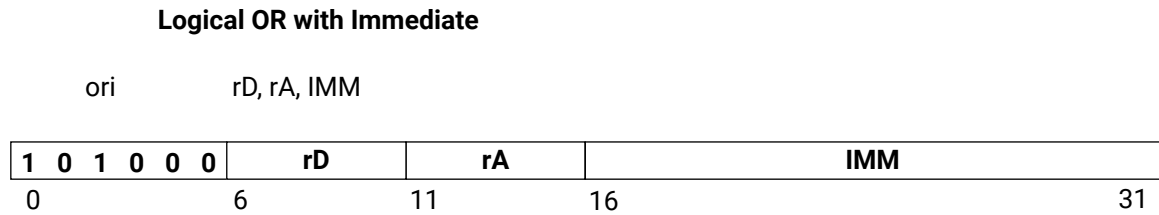

Description

The contents of register rA are ORed with the extended IMM field, sign-extended to 32 bits; the result is placed into register rD.

Pseudocode

```
(rD) ← (rA) ∨ sext(IMM)
```

Registers Altered

- rD

Latency

- 1 cycle

Note

- By default, Type B Instructions will take the 16-bit IMM field value and sign extend it to 32 bits to use as the immediate operand. This behavior can be overridden by preceding the Type B instruction with an imm instruction. See the instruction [imm](#) for details on using 32-bit immediate values.

pcmpbf

Figure 116: pcmpbf

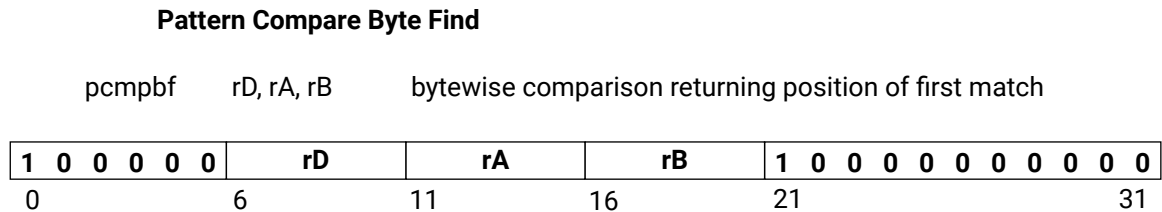

Description

The contents of register rA are bitwise compared with the contents in register rB.

- rD is loaded with the position of the first matching byte pair, starting with MSB as position 1, and comparing until LSB as position 4
- If none of the byte pairs match, rD is set to 0

Pseudocode

```

if rB[0:7] = rA[0:7] then
    (rD) ← 1
else
    if rB[8:15] = rA[8:15] then
        (rD) ← 2
    else
        if rB[16:23] = rA[16:23] then
            (rD) ← 3
        else
            if rB[24:31] = rA[24:31] then
                (rD) ← 4
            else
                (rD) ← 0
    
```

Registers Altered

- rD

Latency

- 1 cycle

Note

- This instruction is only available when the parameter C_USE_PCMP_INSTR is set to 1.

pcmpeq

Figure 117: pcmpeq

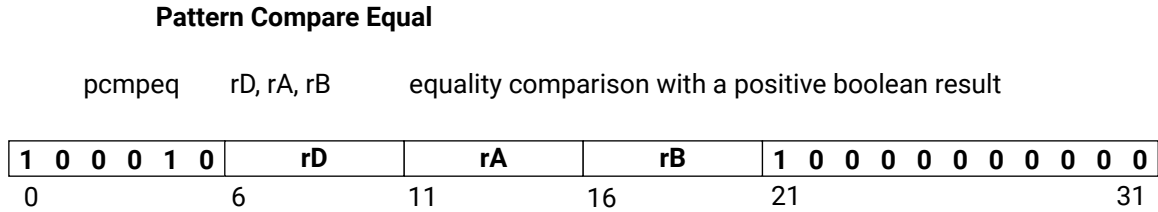

Description

The contents of register rA are compared with the contents in register rB.

- rD is loaded with 1 if they match, and 0 if not

Pseudocode

```

if (rB) = (rA) then
    (rD) ← 1
else
    (rD) ← 0
    
```

Registers Altered

- rD

Latency

- 1 cycle

Note

- This instruction is only available when the parameter C_USE_PCMPEQ_INSTR is set to 1.

pcmpne

Figure 118: pcmpne

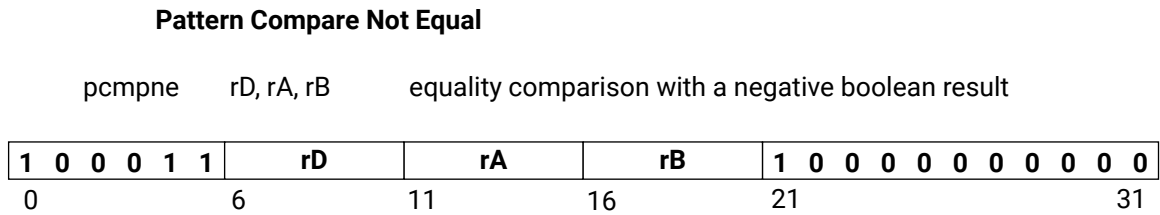

Description

The contents of register rA are compared with the contents in register rB.

- rD is loaded with 0 if they match, and 1 if not

Pseudocode

```

if (rB) = (rA) then
    (rD) ← 0
else
    (rD) ← 1
    
```

Registers Altered

- rD

Latency

- 1 cycle

Note

- This instruction is only available when the parameter C_USE_PCMP_INSTR is set to 1.

put

Figure 119: put

Put to stream interface

<i>n</i> aput	rA, FSLx	put data to link x n = non-blocking a = atomic
<i>t</i> naput	FSLx	put data to link x test-only n = non-blocking a = atomic
<i>n</i> caput	rA, FSLx	put control to link x n = non-blocking a = atomic
<i>t</i> ncaput	FSLx	put control to link x test only n = non-blocking a = atomic

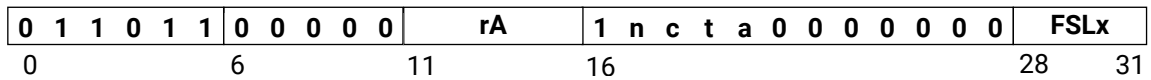

Description

MicroBlaze will write the value from register rA to the link x interface. If the available number of links set by C_FSL_LINKS is less than or equal to FSLx, the used link is undefined.

The put instruction has 16 variants.

The blocking versions (when 'n' is '0') will stall MicroBlaze until there is space available in the interface. The non-blocking versions will not stall MicroBlaze and will set carry to '0' if space was available and to '1' if no space was available.

Except for the test versions, all data put instructions (when 'c' is '0') will set the control bit to the interface to '0' and all control put instructions (when 'c' is '1') will set the control bit to '1'.

The test versions (when 't' bit is '1') will be handled as the normal case, except that the write signal to the link is not asserted (thus no source register is required) and link data is not assigned.

Atomic versions (when 'a' bit is '1') are not interruptible. Each atomic instruction prevents the subsequent instruction from being interrupted. This means that a sequence of atomic instructions can be grouped together without an interrupt breaking the program flow. However, exceptions might still occur.

When MicroBlaze is configured to use an MMU (C_USE_MMU >= 1) and not explicitly allowed by setting C_MMU_PRIVILEGED_INSTR to 1 these instructions are privileged. This means that if these instructions are attempted in User Mode (MSR[UM] = 1) a Privileged Instruction exception occurs.

Pseudocode

```

if MSR[UM] = 1 then
    ESR[EC] ← 00111
else
    x ← FSLx
    if x >= C_FSL_LINKS then
        x ← undefined
    if (t = 0) then
        Mx_AXIS_TDATA ← (rA)
    if (n = 1) then
        MSR[Carry] ← Mx_AXIS_TVALID ∧ Mx_AXIS_TREADY
    if (t = 0) then
        Mx_AXIS_TLAST ← C

```

Registers Altered

- MSR[Carry]
- ESR[EC], in case a privileged instruction exception is generated

Latency

- 1 cycle with C_AREA_OPTIMIZED=0 or 2
- 2 cycles with C_AREA_OPTIMIZED=1

Notes

- To refer to an FSLx interface in assembly language, use rfsI0, rfsI1, ... rfsI15.
- The blocking versions of this instruction should not be placed in a delay slot when the parameter C_USE_EXTENDED_FSL_INSTR is set to 1, because this prevents interrupts from being served.
- These instructions are only available when the MicroBlaze parameter C_FSL_LINKS is greater than 0.
- The extended instructions (test and atomic versions) are only available when the MicroBlaze parameter C_USE_EXTENDED_FSL_INSTR is set to 1.
- It is not recommended to allow these instructions in user mode, unless absolutely necessary for performance reasons, because that removes all hardware protection preventing incorrect use of a link.

putd

Figure 120: putd

Put to stream interface dynamic

<i>naputd</i>	rA, rB	put data to link rB[28:31] n = non-blocking a = atomic
<i>tnaputd</i>	rB	put data to link rB[28:31] test-only n = non-blocking a = atomic
<i>ncaputd</i>	rA, rB	put control to link rB[28:31] n = non-blocking a = atomic
<i>tncaputd</i>	rB	put control to link rB[28:31] test only n = non-blocking a = atomic



Description

MicroBlaze will write the value from register rA to the link interface defined by the four least significant bits in rB. If the available number of links set by `C_FSL_LINKS` is less than or equal to the four least significant bits in rB, the used link is undefined.

The putd instruction has 16 variants.

The blocking versions (when 'n' is '0') will stall MicroBlaze until there is space available in the interface. The non-blocking versions will not stall MicroBlaze and will set carry to '0' if space was available and to '1' if no space was available.

Except for the test versions, all data putd instructions (when 'c' is '0') will set the control bit to the interface to '0' and all control putd instructions (when 'c' is '1') will set the control bit to '1'.

The test versions (when 't' bit is '1') will be handled as the normal case, except that the write signal to the link is not asserted (thus no source register is required) and link data is not assigned.

Atomic versions (when 'a' bit is '1') are not interruptible. Each atomic instruction prevents the subsequent instruction from being interrupted. This means that a sequence of atomic instructions can be grouped together without an interrupt breaking the program flow. However, exceptions might still occur.

When MicroBlaze is configured to use an MMU ($C_USE_MMU \geq 1$) and not explicitly allowed by setting $C_MMU_PRIVILEGED_INSTR$ to 1 these instructions are privileged. This means that if these instructions are attempted in User Mode ($MSR[UM] = 1$) a Privileged Instruction exception occurs.

Pseudocode

```

if MSR[UM] = 1 then
    ESR[EC] ← 00111
else
    x ← rB[28:31]
    if x ≥ C_FSL_LINKS then
        x ← undefined
    if (t = 0) then
        Mx_AXIS_TDATA ← (rA)
    if (n = 1) then
        MSR[Carry] ← Mx_AXIS_TVALID ∧ Mx_AXIS_TREADY
    if (t = 0) then
        Mx_AXIS_TLAST ← C

```

Registers Altered

- MSR[Carry]
- ESR[EC], in case a privileged instruction exception is generated

Latency

- 1 cycle with $C_AREA_OPTIMIZED=0$ or 2
- 2 cycles with $C_AREA_OPTIMIZED=1$

Notes

- The blocking versions of this instruction should not be placed in a delay slot, because this prevents interrupts from being served.
- These instructions are only available when the MicroBlaze parameter C_FSL_LINKS is greater than 0 and the parameter $C_USE_EXTENDED_FSL_INSTR$ is set to 1.

It is not recommended to allow these instructions in user mode, unless absolutely necessary for performance reasons, because that removes all hardware protection preventing incorrect use of a link.

Note

- In subtractions, Carry = (Borrow). When the Carry is set by a subtraction, it means that there is no Borrow, and when the Carry is cleared, it means that there is a Borrow.

rsubi

Figure 122: rsubi

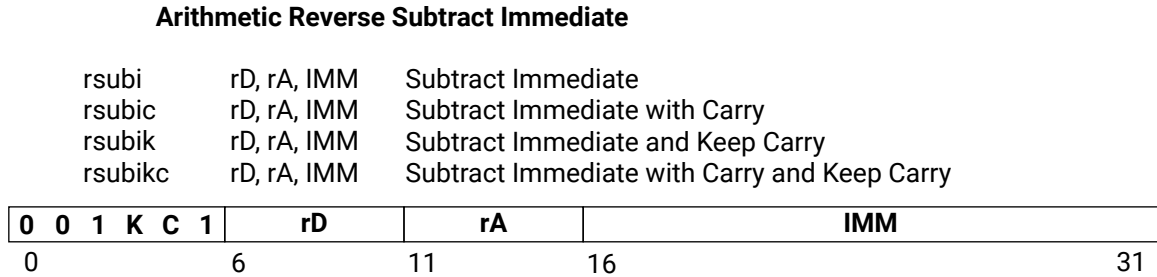

Description

The contents of register rA are subtracted from the value of IMM, sign-extended to 32 bits, and the result is placed into register rD. Bit 3 of the instruction (labeled as K in the figure) is set to one for the mnemonic rsubik. Bit 4 of the instruction (labeled as C in the figure) is set to one for the mnemonic rsubic. Both bits are set to one for the mnemonic rsubikc.

When an rsubi instruction has bit 3 set (rsubik, rsubikc), the carry flag will Keep its previous value regardless of the outcome of the execution of the instruction. If bit 3 is cleared (rsubi, rsubic), then the carry flag will be affected by the execution of the instruction. When bit 4 of the instruction is set to one (rsubic, rsubikc), the content of the carry flag (MSR[C]) affects the execution of the instruction. When bit 4 is cleared (rsubi, rsubik), the content of the carry flag does not affect the execution of the instruction (providing a normal subtraction).

Pseudocode

```

if C = 0 then
    (rD) ← sext(IMM) + ( $\overline{rA}$ ) + 1
else
    (rD) ← sext(IMM) + ( $\overline{rA}$ ) + MSR[C]
if K = 0 then
    MSR[C] ← CarryOut
    
```

Registers Altered

- rD
- MSR[C]

Latency

- 1 cycle

Note

- In subtractions, Carry = (Borrow). When the Carry is set by a subtraction, it means that there is no Borrow, and when the Carry is cleared, it means that there is a Borrow. By default, Type B Instructions will take the 16-bit IMM field value and sign extend it to 32 bits to use as the immediate operand. This behavior can be overridden by preceding the Type B instruction with an `imm` instruction. See the instruction [imm](#) for details on using 32-bit immediate values.

rtbd

Figure 123: rtbd



Description

Return from break will branch to the location specified by the contents of rAx plus the sign-extended IMM field. It will also enable breaks after execution by clearing the BIP flag in the MSR.

This instruction always has a delay slot. The instruction following the RTBD is always executed before the branch target. That delay slot instruction has breaks disabled.

When MicroBlaze is configured to use an MMU ($C_USE_MMU \geq 1$) this instruction is privileged. This means that if the instruction is attempted in User Mode ($MSR[UM] = 1$) a Privileged Instruction exception occurs.

Pseudocode

```

if MSR[UM] = 1 then
    ESR[EC] ← 00111
else
    PC ← (rAx) + sext(IMM)
    allow following instruction to complete execution
    MSR[BIP] ← 0
    MSR[UM] ← MSR[UMS]
    MSR[VM] ← MSR[VMS]
    
```

Registers Altered

- PC
- MSR[BIP], MSR[UM], MSR[VM]
- ESR[EC], in case a privileged instruction exception is generated

Latency

- 2 cycles (with $C_AREA_OPTIMIZED \neq 2$)
- 6 cycles (with $C_AREA_OPTIMIZED = 2$)

If $C_USE_MMU > 1$ two additional cycles are added with $C_AREA_OPTIMIZED = 2$.

Notes

- Convention is to use general purpose register r16 as rAx.
- A delay slot must not be used by the following: imm, branch, or break instructions. Interrupts and external hardware breaks are deferred until after the delay slot branch has been completed.

rtid

Figure 124: rtid

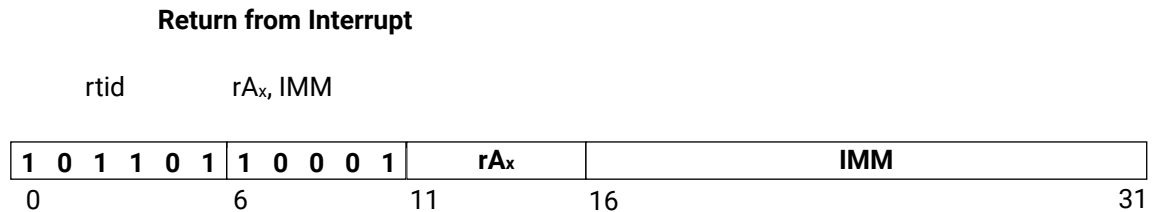

Description

Return from interrupt will branch to the location specified by the contents of rAx plus the sign-extended IMM field. It will also enable interrupts after execution.

This instruction always has a delay slot. The instruction following the RTID is always executed before the branch target. That delay slot instruction has interrupts disabled.

When MicroBlaze is configured to use an MMU ($C_USE_MMU \geq 1$) this instruction is privileged. This means that if the instruction is attempted in User Mode ($MSR[UM] = 1$) a Privileged Instruction exception occurs.

With low-latency interrupt mode ($C_USE_INTERRUPT = 2$), the Interrupt_Ack output port is set to 10 when this instruction is executed, and subsequently to 11 when the MSR{IE} bit is set.

Pseudocode

```

if MSR[UM] = 1 then
    ESR[EC] ← 00111
else
    PC ← (rAx) + sext(IMM)
    Interrupt_Ack ← 10
    allow following instruction to complete execution
    MSR[IE] ← 1
    MSR[UM] ← MSR[UMS]
    MSR[VM] ← MSR[VMS]
    Interrupt_Ack ← 11

```

Registers Altered

- PC
- MSR[IE], MSR[UM], MSR[VM]
- ESR[EC], in case a privileged instruction exception is generated

Latency

- 2 cycles (with $C_AREA_OPTIMIZED \neq 2$)

- 6 cycles (with `C_AREA_OPTIMIZED=2`)

If `C_USE_MMU > 1` two additional cycles are added with `C_AREA_OPTIMIZED=2`.

Notes

- Convention is to use general purpose register r14 as `rAx`.
- A delay slot must not be used by the following: `imm`, `branch`, or `break` instructions. Interrupts and external hardware breaks are deferred until after the delay slot branch has been completed.

rted

Figure 125: rted

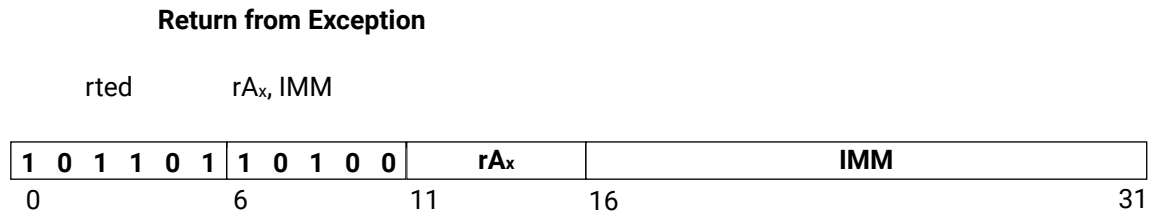

Description

Return from exception will branch to the location specified by the contents of rAx plus the sign-extended IMM field. The instruction will also enable exceptions after execution.

This instruction always has a delay slot. The instruction following the RTED is always executed before the branch target.

When MicroBlaze is configured to use an MMU ($C_USE_MMU \geq 1$) this instruction is privileged. This means that if the instruction is attempted in User Mode ($MSR[UM] = 1$) a Privileged Instruction exception occurs.

Pseudocode

```

if MSR[UM] = 1 then
    ESR[EC] ← 00111
else
    PC ← (rAx) + sext(IMM)
    allow following instruction to complete execution
    MSR[EE] ← 1
    MSR[EIP] ← 0
    MSR[UM] ← MSR[UMS]
    MSR[VM] ← MSR[VMS]
    ESR ← 0
    
```

Registers Altered

- PC
- MSR[EE], MSR[EIP], MSR[UM], MSR[VM]
- ESR

Latency

- 2 cycles (with $C_AREA_OPTIMIZED \neq 2$)
- 6 cycles (with $C_AREA_OPTIMIZED = 2$)
- If $C_USE_MMU > 1$ two additional cycles are added with $C_AREA_OPTIMIZED = 2$.

Notes

- Convention is to use general purpose register r17 as rA_X. This instruction requires that one or more of the MicroBlaze parameters C_*_EXCEPTION are set to 1 or that C_USE_MMU > 0.
- A delay slot must not be used by the following: imm, branch, or break instructions. Interrupts and external hardware breaks are deferred until after the delay slot branch has been completed.
- The instruction should normally not be used when MSR[EE] is set, because if the instruction in the delay slot would cause an exception, the exception handler would be entered with exceptions enabled.
- Code returning from an exception must first check if MSR[DS] is set, and in that case return to the address in BTR.

rtsd

Figure 126: rtsd

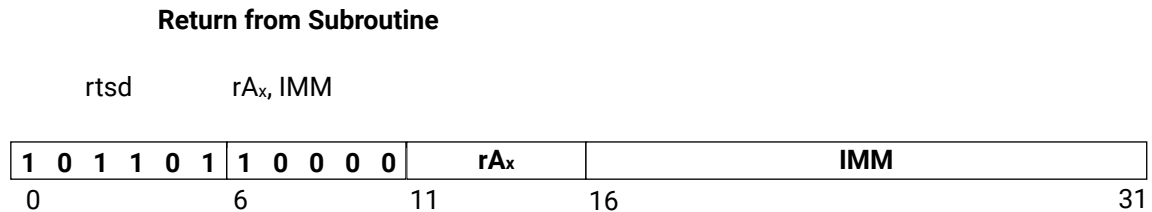

Description

Return from subroutine will branch to the location specified by the contents of rA_x plus the sign-extended IMM field.

This instruction always has a delay slot. The instruction following the RTSD is always executed before the branch target.

Pseudocode

```
PC ← (rAX) + sext(IMM)
allow following instruction to complete execution
```

Registers Altered

- PC

Latency

- 1 cycle (if successful branch prediction occurs)
- 2 cycles (with Branch Target Cache disabled and C_AREA_OPTIMIZED≠2)
- 3 cycles (if branch prediction mispredict occurs with C_AREA_OPTIMIZED=0)
- 6 cycles (with Branch Target Cache disabled and C_AREA_OPTIMIZED=2)
- 7 cycles (if branch prediction mispredict occurs with C_AREA_OPTIMIZED=2)

If C_USE_MMU > 1 two additional cycles are added with C_AREA_OPTIMIZED=2.

Notes

- Convention is to use general purpose register r15 as rA_x.
- A delay slot must not be used by the following: imm, branch, or break instructions. Interrupts and external hardware breaks are deferred until after the delay slot branch has been completed.

sb

Figure 127: sb

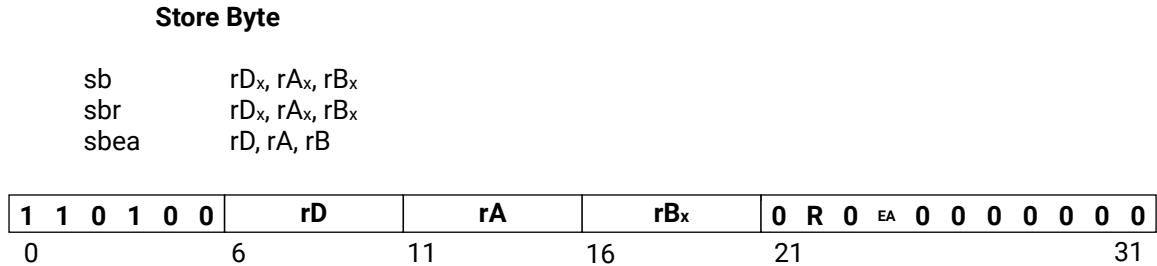

Description

Stores the contents of the least significant byte of register rD, into the memory location that results from adding the contents of registers rA_x and rB_x.

If the R bit is set, a byte reversed memory location is used, storing data with the opposite endianness of the endianness defined by the E bit (if virtual protected mode is enabled).

If the EA bit is set, an extended address is used, formed by concatenating rA and rB instead of adding them.

A data TLB miss exception occurs if virtual protected mode is enabled, and a valid translation entry corresponding to the address is not found in the TLB.

A data storage exception occurs if virtual protected mode is enabled, and access is prevented by no-access-allowed or read-only zone protection. No-access-allowed can only occur in user mode.

A privileged instruction error occurs if the EA bit is set, Physical Address Extension (PAE) is enabled, and the instruction is not explicitly allowed.

Pseudocode

```

if EA = 1 then
    Addr ← (rA) & (rB)
else
    Addr ← (rAx) + (rBx)
if TLB_Miss(Addr) and MSR[VM] = 1 then
    ESR[EC] ← 10010; ESR[S] ← 1
    MSR[UMS] ← MSR[UM]; MSR[VMS] ← MSR[VM]; MSR[UM] ← 0; MSR[VM] ← 0
else if Access_Protected(Addr) and MSR[VM] = 1 then
    ESR[EC] ← 10000; ESR[S] ← 1; ESR[DIZ] ← No-access-allowed
    MSR[UMS] ← MSR[UM]; MSR[VMS] ← MSR[VM]; MSR[UM] ← 0; MSR[VM] ← 0
else
    Mem(Addr) ← (rD)[C_DATA_SIZE-8:C_DATA_SIZE-1]
    
```

Registers Altered

- MSR[UM], MSR[VM], MSR[UMS], MSR[VMS], if an exception is generated
- ESR[EC], ESR[S], if an exception is generated
- ESR[DIZ], if a data storage exception is generated

Latency

- 1 cycle with C_AREA_OPTIMIZED=0 or 2
- 2 cycles with C_AREA_OPTIMIZED=1

Notes

- The byte reversed instruction is only valid if MicroBlaze is configured to use reorder instructions (C_USE_REORDER_INSTR = 1).
- The extended address instruction is only valid if MicroBlaze is configured to use extended address (C_ADDR_SIZE > 32) and is using 32-bit mode (C_DATA_SIZE = 32).

sbi

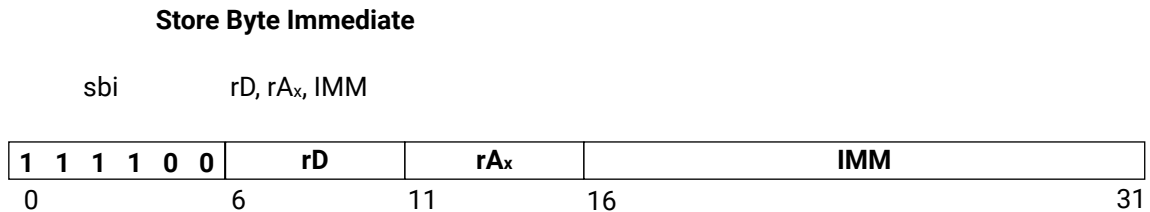
 Figure 128: **sbi**

Description

Stores the contents of the least significant byte of register rD, into the memory location that results from adding the contents of register rAx and the sign-extended IMM value.

A data TLB miss exception occurs if virtual protected mode is enabled, and a valid translation entry corresponding to the address is not found in the TLB.

A data storage exception occurs if virtual protected mode is enabled, and access is prevented by no-access-allowed or read-only zone protection. No-access-allowed can only occur in user mode.

Pseudocode

```

Addr ← (rAx) + sext(IMM)
if TLB_Miss(Addr) and MSR[VM] = 1 then
    ESR[EC] ← 10010; ESR[S] ← 1
    MSR[UMS] ← MSR[UM]; MSR[VMS] ← MSR[VM]; MSR[UM] ← 0; MSR[VM] ← 0
else if Access_Protected(Addr) and MSR[VM] = 1 then
    ESR[EC] ← 10000; ESR[S] ← 1; ESR[DIZ] ← No-access-allowed
    MSR[UMS] ← MSR[UM]; MSR[VMS] ← MSR[VM]; MSR[UM] ← 0; MSR[VM] ← 0
else
    Mem(Addr) ← (rD)[C_DATA_SIZE-8:C_DATA_SIZE-1]
    
```

Registers Altered

- MSR[UM], MSR[VM], MSR[UMS], MSR[VMS], if an exception is generated
- ESR[EC], ESR[S], if an exception is generated
- ESR[DIZ], if a data storage exception is generated

Latency

- 1 cycle with C_AREA_OPTIMIZED=0 or 2
- 2 cycles with C_AREA_OPTIMIZED=1

Notes

- By default, Type B store instructions will take the 16-bit IMM field value and sign extend it to use as the immediate operand. This behavior can be overridden by preceding the instruction with an `imm` or `imml` instruction. See the instructions [imm](#) and [imml](#) for details on using immediate values.

sext16

Figure 129: **sext16**

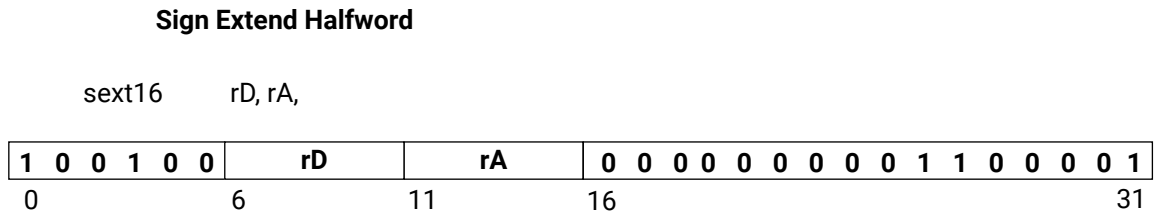

Description

This instruction sign-extends a halfword (16 bits) into a word (32 bits). Bit 16 in rA will be copied into bits 0-15 of rD. Bits 16-31 in rA will be copied into bits 16-31 of rD.

Pseudocode

```
(rD)[0:15] ← (rA)[16]
(rD)[16:31] ← (rA)[16:31]
```

Registers Altered

- rD

Latency

- 1 cycle

sext8

Figure 130: **sext8**

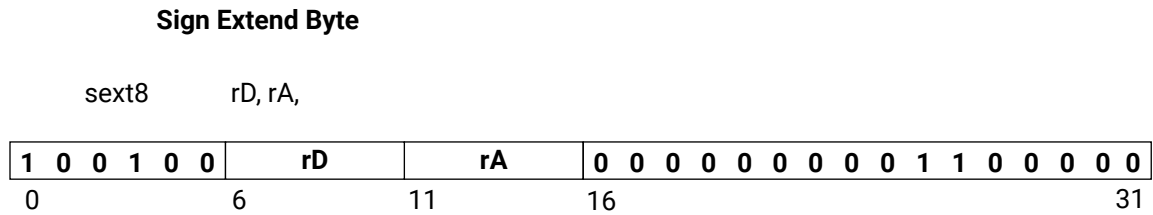

Description

This instruction sign-extends a byte (8 bits) into a word (32 bits). Bit 24 in rA will be copied into bits 0-23 of rD. Bits 24-31 in rA will be copied into bits 24-31 of rD.

Pseudocode

```
(rD)[0:23] ← (rA)[24]
(rD)[24:31] ← (rA)[24:31]
```

Registers Altered

- rD

Latency

- 1 cycle

sh

Figure 131: sh



Description

Stores the contents of the least significant halfword of register rD, into the halfword aligned memory location that results from adding the contents of registers rA_x and rB_x.

If the R bit is set, a halfword reversed memory location is used and the two bytes in the halfword are reversed, storing data with the opposite endianness of the endianness defined by the E bit (if virtual protected mode is enabled).

If the EA bit is set, an extended address is used, formed by concatenating rA and rB instead of adding them.

A data TLB miss exception occurs if virtual protected mode is enabled, and a valid translation entry corresponding to the address is not found in the TLB.

A data storage exception occurs if virtual protected mode is enabled, and access is prevented by no-access-allowed or read-only zone protection. No-access-allowed can only occur in user mode.

An unaligned data access exception occurs if the least significant bit in the address is not zero.

A privileged instruction error occurs if the EA bit is set, Physical Address Extension (PAE) is enabled, and the instruction is not explicitly allowed.

Pseudocode

```

if EA = 1 then
    Addr ← (rA) & (rB)
else
    Addr ← (rAX) + (rBX)
if TLB_Miss(Addr) and MSR[VM] = 1 then
    ESR[EC] ← 10010; ESR[S] ← 1
    MSR[UMS] ← MSR[UM]; MSR[VMS] ← MSR[VM]; MSR[UM] ← 0; MSR[VM] ← 0
else if Access_Protected(Addr) and MSR[VM] = 1 then
    ESR[EC] ← 10000; ESR[S] ← 1 ; ESR[DIZ] ← No-access-allowed
    MSR[UMS] ← MSR[UM]; MSR[VMS] ← MSR[VM]; MSR[UM] ← 0; MSR[VM] ← 0
else if Addr[31] ≠ 0 then
    ESR[EC] ← 00001; ESR[W] ← 0; ESR[S] ← 1; ESR[Rx] ← rD
else
    Mem(Addr) ← (rD)[C_DATA_SIZE-16:C_DATA_SIZE-1]

```

Registers Altered

- MSR[UM], MSR[VM], MSR[UMS], MSR[VMS], if a TLB miss exception or a data storage exception is generated
- ESR[EC], ESR[S], if an exception is generated
- ESR[DIZ], if a data storage exception is generated
- ESR[W], ESR[Rx], if an unaligned data access exception is generated

Latency

- 1 cycle with C_AREA_OPTIMIZED=0 or 2
- 2 cycles with C_AREA_OPTIMIZED=1

Notes

- The halfword reversed instruction is only valid if MicroBlaze is configured to use reorder instructions (C_USE_REORDER_INSTR = 1).
- The extended address instruction is only valid if MicroBlaze is configured to use extended address (C_ADDR_SIZE > 32) and is using 32-bit mode (C_DATA_SIZE = 32).

shi

Figure 132: shi

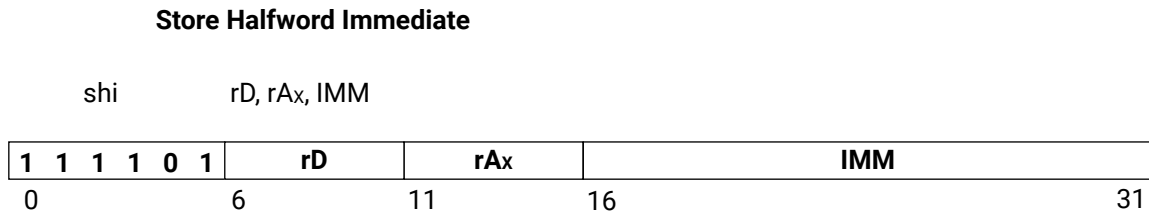

Description

Stores the contents of the least significant halfword of register rD, into the halfword aligned memory location that results from adding the contents of register rAx and the sign-extended IMM value.

A data TLB miss exception occurs if virtual protected mode is enabled, and a valid translation entry corresponding to the address is not found in the TLB. A data storage exception occurs if virtual protected mode is enabled, and access is prevented by no-access-allowed or read-only zone protection. No-access-allowed can only occur in user mode. An unaligned data access exception occurs if the least significant bit in the address is not zero.

Pseudocode

```

Addr ← (rAx) + sext(IMM)
if TLB_Miss(Addr) and MSR[VM] = 1 then
    ESR[EC] ← 10010; ESR[S] ← 1
    MSR[UMS] ← MSR[UM]; MSR[VMS] ← MSR[VM]; MSR[UM] ← 0; MSR[VM] ← 0
else if Access_Protected(Addr) and MSR[VM] = 1 then
    ESR[EC] ← 10000; ESR[S] ← 1 ; ESR[DIZ] ← No-access-allowed
    MSR[UMS] ← MSR[UM]; MSR[VMS] ← MSR[VM]; MSR[UM] ← 0; MSR[VM] ← 0
else if Addr[31] ≠ 0 then
    ESR[EC] ← 00001; ESR[W] ← 0; ESR[S] ← 1; ESR[Rx] ← rD
else
    Mem(Addr) ← (rD)[C_DATA_SIZE-16:C_DATA_SIZE-1]
    
```

Registers Altered

- MSR[UM], MSR[VM], MSR[UMS], MSR[VMS], if a TLB miss exception or a data storage exception is generated
- ESR[EC], ESR[S], if an exception is generated
- ESR[DIZ], if a data storage exception is generated
- ESR[W], ESR[Rx], if an unaligned data access exception is generated

Latency

- 1 cycle with `C_AREA_OPTIMIZED=0` or 2
- 2 cycles with `C_AREA_OPTIMIZED=1`

Notes

- By default, Type B store instructions will take the 16-bit IMM field value and sign extend it to use as the immediate operand. This behavior can be overridden by preceding the instruction with an `imm` or `imml` instruction. See the instructions [imm](#) and [imml](#) for details on using immediate values.

src

Figure 134: src

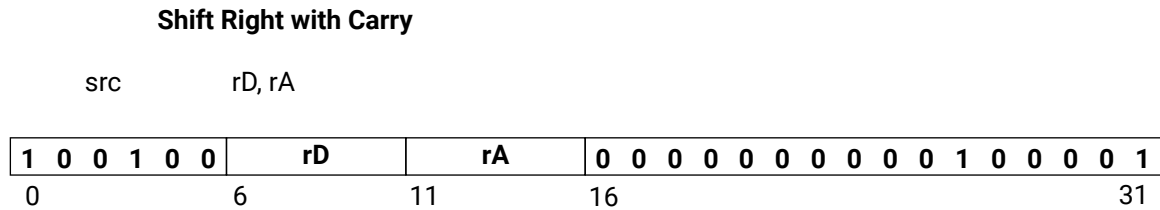

Description

Shifts the contents of register rA, one bit to the right, and places the result in rD. The Carry flag is shifted in the shift chain and placed in the most significant bit of rD. The least significant bit coming out of the shift chain is placed in the Carry flag.

Pseudocode

```
(rD)[0] ← MSR[C]
(rD)[1:31] ← (rA)[0:30]
MSR[C] ← (rA)[31]
```

Registers Altered

- rD
- MSR[C]

Latency

- 1 cycle

srl

Figure 135: srl

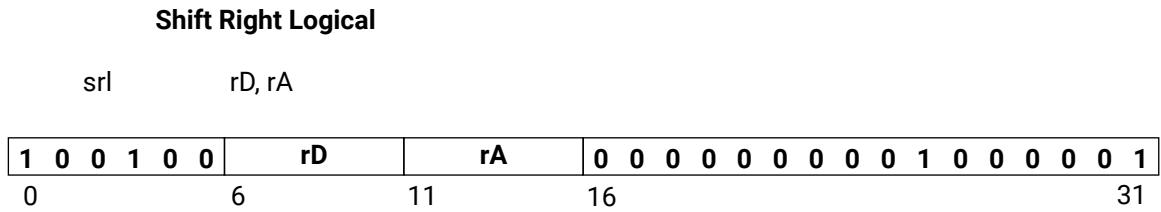

Description

Shifts logically the contents of register rA, one bit to the right, and places the result in rD. A zero is shifted in the shift chain and placed in the most significant bit of rD. The least significant bit coming out of the shift chain is placed in the Carry flag.

Pseudocode

```
(rD)[0] ← 0
(rD)[1:31] ← (rA)[0:30]
MSR[C] ← (rA)[31]
```

Registers Altered

- rD
- MSR[C]

Latency

- 1 cycle

SW

Figure 136: **sw**

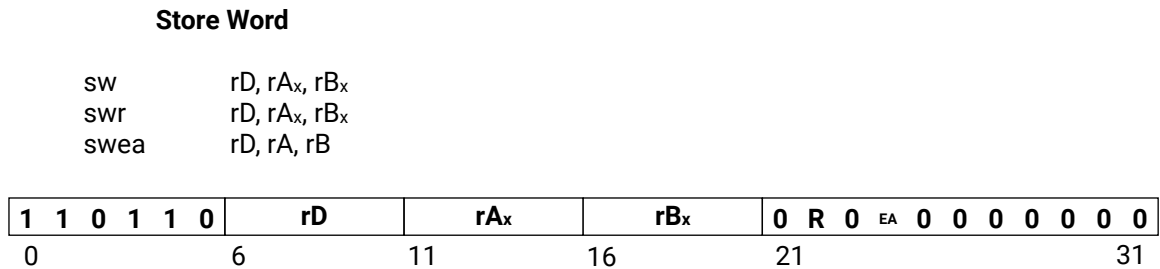

Description

Stores the contents of register rD, into the word aligned memory location that results from adding the contents of registers rA_x and rB_x.

If the R bit is set, the bytes in the stored word are reversed, storing data with the opposite endianness of the endianness defined by the E bit (if virtual protected mode is enabled).

If the EA bit is set, an extended address is used, formed by concatenating rA and rB instead of adding them.

A data TLB miss exception occurs if virtual protected mode is enabled, and a valid translation entry corresponding to the address is not found in the TLB.

A data storage exception occurs if virtual protected mode is enabled, and access is prevented by no-access-allowed or read-only zone protection. No-access-allowed can only occur in user mode.

An unaligned data access exception occurs if the two least significant bits in the address are not zero.

A privileged instruction error occurs if the EA bit is set, Physical Address Extension (PAE) is enabled, and the instruction is not explicitly allowed.

Pseudocode

```

if EA = 1 then
    Addr ← (rA) & (rB)
else
    Addr ← (rAX) + (rBX)
if TLB_Miss(Addr) and MSR[VM] = 1 then
    ESR[EC] ← 10010; ESR[S] ← 1
    MSR[UMS] ← MSR[UM]; MSR[VMS] ← MSR[VM]; MSR[UM] ← 0; MSR[VM] ← 0
else if Access_Protected(Addr) and MSR[VM] = 1 then
    ESR[EC] ← 10000; ESR[S] ← 1 ; ESR[DIZ] ← No-access-allowed
    MSR[UMS] ← MSR[UM]; MSR[VMS] ← MSR[VM]; MSR[UM] ← 0; MSR[VM] ← 0
else if Addr[30:31] ≠ 0 then
    ESR[EC] ← 00001; ESR[W] ← 1; ESR[S] ← 1; ESR[Rx] ← rD
else
    Mem(Addr) ← (rD)

```

Registers Altered

- MSR[UM], MSR[VM], MSR[UMS], MSR[VMS], if a TLB miss exception or a data storage exception is generated
- ESR[EC], ESR[S], if an exception is generated
- ESR[DIZ], if a data storage exception is generated
- ESR[W], ESR[R_x], if an unaligned data access exception is generated

Latency

- 1 cycle with C_AREA_OPTIMIZED=0 or 2
- 2 cycles with C_AREA_OPTIMIZED=1

Notes

- The word reversed instruction is only valid if MicroBlaze is configured to use reorder instructions (C_USE_REORDER_INSTR = 1).
- The extended address instruction is only valid if MicroBlaze is configured to use extended address (C_ADDR_SIZE > 32) and is using 32-bit mode (C_DATA_SIZE = 32).

swapb

Figure 137: **swapb**

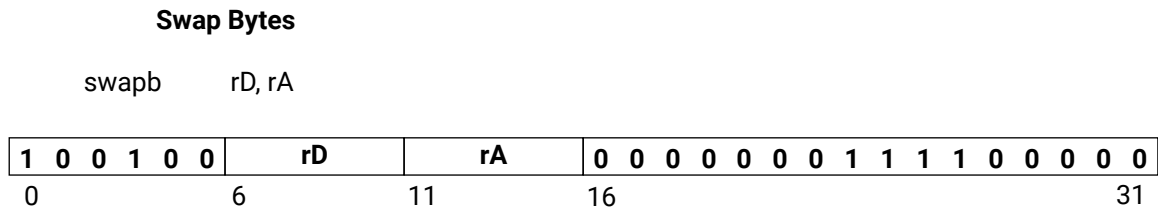

Description

Swaps the contents of register *rA* treated as four bytes, and places the result in *rD*. This effectively converts the byte sequence in the register between endianness formats, either from little-endian to big-endian or vice versa.

Pseudocode

```
(rD)[24:31] ← (rA)[0:7]
(rD)[16:23] ← (rA)[8:15]
(rD)[8:15]  ← (rA)[16:23]
(rD)[0:7]   ← (rA)[24:31]
```

Registers Altered

- rD

Latency

- 1 cycle

Note

- This instruction is only valid if MicroBlaze is configured to use reorder instructions (`C_USE_REORDER_INSTR = 1`).

swaph

Figure 138: swaph

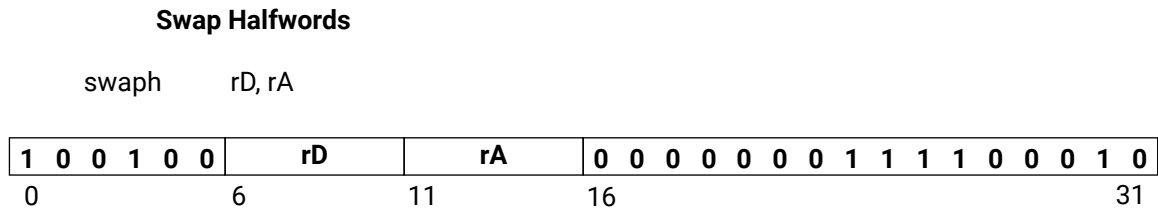

Description

Swaps the contents of register *rA* treated as two halfwords, and places the result in *rD*. This effectively converts the two halfwords in the register between endianness formats, either from little-endian to big-endian or vice versa.

Pseudocode

```
(rD)[0:15] ← (rA)[16:31]
(rD)[16:31] ← (rA)[0:15]
```

Registers Altered

- *rD*

Latency

- 1 cycle

Note

- This instruction is only valid if MicroBlaze is configured to use reorder instructions (`C_USE_REORDER_INSTR = 1`).

Latency

- 1 cycle with `C_AREA_OPTIMIZED=0` or 2
- 2 cycles with `C_AREA_OPTIMIZED=1`

Note

- By default, Type B store instructions will take the 16-bit IMM field value and sign extend it to use as the immediate operand. This behavior can be overridden by preceding the instruction with an `imm` or `imml` instruction. See the instructions [imm](#) and [imml](#) for details on using immediate values.

Pseudocode

```

Addr ← (rA) + (rB)
if Reservation = 0 then
  MSR[C] ← 1
else
  if TLB_Miss(Addr) and MSR[VM] = 1 then
    ESR[EC] ← 10010; ESR[S] ← 1
    MSR[UMS] ← MSR[UM]; MSR[VMS] ← MSR[VM]; MSR[UM] ← 0; MSR[VM] ← 0
  else if Access_Protected(Addr) and MSR[VM] = 1 then
    ESR[EC] ← 10000; ESR[S] ← 1 ; ESR[DIZ] ← No-access-allowed
    MSR[UMS] ← MSR[UM]; MSR[VMS] ← MSR[VM]; MSR[UM] ← 0; MSR[VM] ← 0
  else
    Reservation ← 0
    if AXI_Exclusive(Addr) and AXI_Response ≠ EXOKAY then
      MSR[C] ← 1
    else
      Mem(Addr) ← (rD)[0:31]
      MSR[C] ← 0

```

Registers Altered

- MSR[C], unless an exception is generated
- MSR[UM], MSR[VM], MSR[UMS], MSR[VMS], if a TLB miss exception or a data storage exception is generated
- ESR[EC], ESR[S], if an exception is generated
- ESR[DIZ], if a data storage exception is generated

Latency

- 1 cycle with C_AREA_OPTIMIZED=0 or 2
- 2 cycles with C_AREA_OPTIMIZED=1

Notes

- This instruction is used together with LWX to implement exclusive access, such as semaphores and spinlocks.
- The carry flag (MSR[C]) might not be set immediately (dependent on pipeline stall behavior). The SWX instruction should not be immediately followed by an MSRCLR, MSRSET, MTS, or SRC instruction, to ensure the correct value of the carry flag is obtained.

wdc

Figure 141: wdc

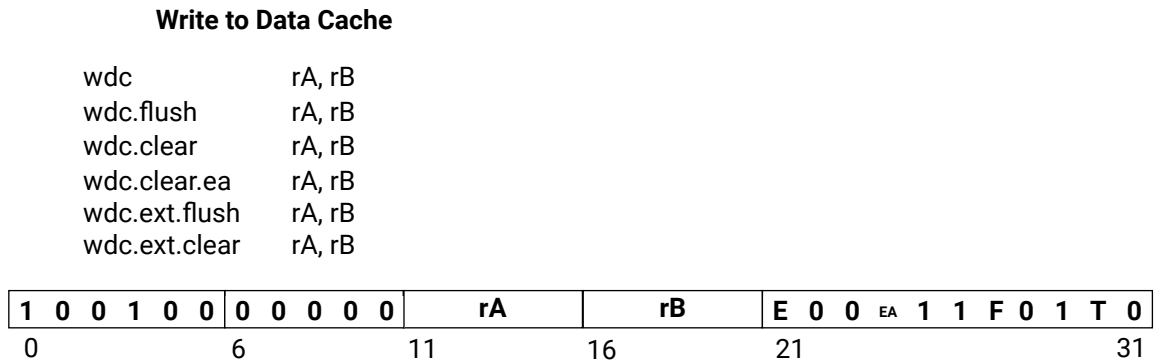

Description

Write into the data cache tag to invalidate or flush a cache line. The mnemonic wdc.flush is used to set the F bit, wdc.clear is used to set the T bit, wdc.clear.ea is used to set the T and EA bits, wdc.ext.flush is used to set the E, F, and T bits, and wdc.ext.clear is used to set the E and T bits.

When C_DCACHE_USE_WRITEBACK is set to 1:

- If the F bits is set, the instruction will flush and invalidate the cache line.
- Otherwise, the instruction will only invalidate the cache line and discard any data that has not been written to memory.
- If the T bit is set, only a cache line with a matching address is invalidated:
 - If the EA bit is set register rA concatenated with rB is the extended address of the affected cache line.
 - Otherwise, register rA added with rB is the address of the affected cache line.
 - The EA bit is only taken into account when the parameter C_ADDR_SIZE > 32.
- The E bit is not taken into account.
- The F and T bits cannot be used at the same time.

When C_DCACHE_USE_WRITEBACK is cleared to 0:

- If the E bit is not set, the instruction will invalidate the cache line. Register rA contains the address of the affected cache line, and the register rB value is not used.
- Otherwise, MicroBlaze will request that the matching address in an external cache should be invalidated or flushed, depending on the value of the F bit, and invalidate the internal affected cache line. Register rA added with rB is the address in the external cache, and of the affected cache line.

- The E bit is only taken into account when the parameter `C_INTERCONNECT` is set to 3 (ACE).

When MicroBlaze is configured to use an MMU (`C_USE_MMU >= 1`) the instruction is privileged. This means that if the instruction is attempted in User Mode (`MSR[UM] = 1`) a Privileged Instruction exception occurs.

Pseudocode

```

if MSR[UM] = 1 then
    ESR[EC] ← 00111
else
    if C_DCACHE_USE_WRITEBACK = 1 then
        if T = 1 and EA = 1 then
            address ← (rA) & (rB)
        else
            address ← (rA) + (rB)
    else if E = 0 then
        address ← (rA)
    else
        address ← (rA) + (rB)
    if C_DCACHE_LINE_LEN = 4 then
        cacheline_mask ← (1 << log2(C_DCACHE_BYTE_SIZE) - 4) - 1
        cacheline ← (DCache Line)[(address >> 4) ^ cacheline_mask]
        cacheline_addr ← address & 0xffffffff0
    if C_DCACHE_LINE_LEN = 8 then
        cacheline_mask ← (1 << log2(C_DCACHE_BYTE_SIZE) - 5) - 1
        cacheline ← (DCache Line)[(address >> 5) ^ cacheline_mask]
        cacheline_addr ← address & 0xffffffe0
    if C_DCACHE_LINE_LEN = 16 then
        cacheline_mask ← (1 << log2(C_DCACHE_BYTE_SIZE) - 6) - 1
        cacheline ← (DCache Line)[(address >> 6) ^ cacheline_mask]
        cacheline_addr ← address & 0xffffffc0
    if E = 0 and F = 1 and cacheline.Dirty then
        for i = 0 .. C_DCACHE_LINE_LEN - 1 loop
            if cacheline.Valid[i] then
                Mem(cacheline_addr + i * 4) ← cacheline.Data[i]
    if T = 0 or C_DCACHE_USE_WRITEBACK = 0 then
        cacheline.Tag ← 0
    else if cacheline.Address = cacheline_addr then
        cacheline.Tag ← 0
    if E = 1 then
        if F = 1 then
            request external cache flush with address
        else
            request external cache invalidate with address

```

Registers Altered

- ESR[EC], in case a privileged instruction exception is generated

Latency

- 2 cycles for `wdc.clear`
- 2 cycles for `wdc` with `C_AREA_OPTIMIZED=0` or 2
- 3 cycles for `wdc` with `C_AREA_OPTIMIZED=0`

- 2 + N cycles for wdc.flush, where N is the number of clock cycles required to flush the cache line to memory when necessary

Notes

- The wdc, wdc.flush, wdc.clear and wdc.clear.ea instructions are independent of data cache enable (MSR[DCE]), and can be used either with the data cache enabled or disabled.
- The wdc.clear and wdc.clear.ea instructions are intended to invalidate a specific area in memory, for example a buffer to be written by a Direct Memory Access device.
- Using this instruction ensures that other cache lines are not inadvertently invalidated, erroneously discarding data that has not yet been written to memory.
- The address of the affected cache line is always the physical address, independent of the parameter C_USE_MMU and whether the MMU is in virtual mode or real mode.
- When using wdc.flush in a loop to flush the entire cache, the loop can be optimized by using rA as the cache base address and rB as the loop counter:

```

addik      r5, r0, C_DCACHE_BASEADDR
addik      r6, r0, C_DCACHE_BYTE_SIZE - C_DCACHE_LINE_LEN * 4
loop: wdc.flush r5, r6
bgtid     r6, loop
addik     r6, r6, -C_DCACHE_LINE_LEN * 4

```

- When using wdc.clear in a loop to invalidate a memory area in the cache, the loop can be optimized by using rA as the memory area base address and rB as the loop counter:

```

addik      r5, r0, memory_area_base_address
addik      r6, r0, memory_area_byte_size - C_DCACHE_LINE_LEN * 4
loop: wdc.clear r5, r6
bgtid     r6, loop
addik     r6, r6, -C_DCACHE_LINE_LEN * 4

```

xori

Figure 144: xori

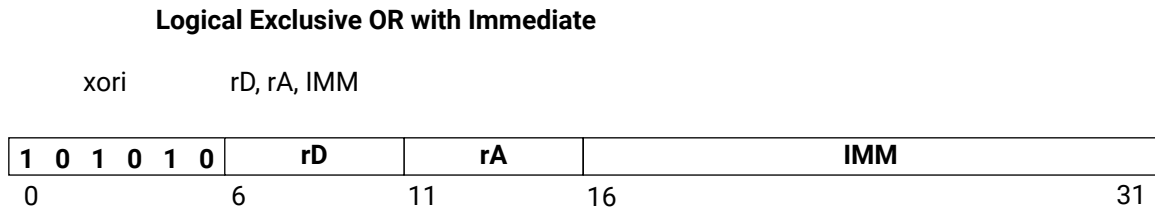

Description

The IMM field is extended to 32 bits by concatenating 16 0-bits on the left. The contents of register rA are XOR'ed with the extended IMM field; the result is placed into register rD.

Pseudocode

```
(rD) ← (rA) ⊕ sext(IMM)
```

Registers Altered

- rD

Latency

- 1 cycle

Notes

- By default, Type B Instructions will take the 16-bit IMM field value and sign extend it to 32 bits to use as the immediate operand. This behavior can be overridden by preceding the Type B instruction with an imm instruction. See the instruction [imm](#) for details on using 32-bit immediate values.
- When this instruction is used with rD set to r0, a program trace event is emitted with the 14 least significant bits of the result. Typically this is used to trace operating system events like context switches and system calls, but it can be used by any program to trace significant events. The functionality is enabled by setting `C_DEBUG_ENABLED = 2 (Extended)` and `C_DEBUG_TRACE_SIZE > 0`. See [Program and Event Trace](#) for further details.

MicroBlaze 64-bit Instructions

All additional instructions included in the instruction set for 64-bit MicroBlaze are defined in this section.

These instructions use the full 64-bit register size to provide long arithmetic and logical operations.

All Type B 64-bit arithmetic and logical instructions must be preceded by an `imml` instruction, to indicate that they are 64-bit instructions. See the instruction [imml](#) for details on using 64-bit immediate values.

The extended instruction set also defines double precision floating point instructions.

The 64-bit instruction set does not define a long multiplication instruction to multiply two 64-bit values with a 64-bit result.

addl

 Figure 145: **addl**

Arithmetic Add Long

addl	rD _L , rA _L , rB _L	Add Long
addlc	rD _L , rA _L , rB _L	Add Long with Carry
addlk	rD _L , rA _L , rB _L	Add Long and Keep Carry
addlkc	rD _L , rA _L , rB _L	Add Long with Carry and Keep Carry

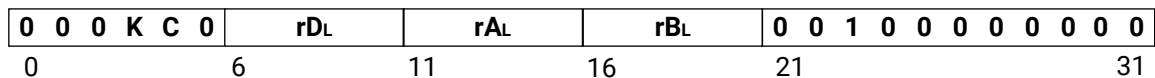

Description

The sum of the contents of registers rA_L and rB_L, is placed into register rD_L.

Bit 3 of the instruction (labeled as K in the figure) is set to one for the mnemonic addlk. Bit 4 of the instruction (labeled as C in the figure) is set to one for the mnemonic addlc. Both bits are set to one for the mnemonic addlkc.

When an add instruction has bit 3 set (addlk, addlkc), the carry flag will Keep its previous value regardless of the outcome of the execution of the instruction. If bit 3 is cleared (addl, addlc), then the carry flag will be affected by the execution of the instruction.

When bit 4 of the instruction is set to one (addlc, addlkc), the content of the carry flag (MSR[C]) affects the execution of the instruction. When bit 4 is cleared (addl, addlk), the content of the carry flag does not affect the execution of the instruction (providing a normal addition).

Pseudocode

```

if C = 0 then
    (rDL) ← (rAL) + (rBL)
else
    (rDL) ← (rAL) + (rBL) + MSR[C]
if K = 0 then
    MSR[C] ← CarryOut64
    
```

Registers Altered

- rD_L
- MSR[C]

Latency

- 1 cycle

Notes

- The C bit in the instruction opcode is not the same as the carry bit in the MSR.

addli

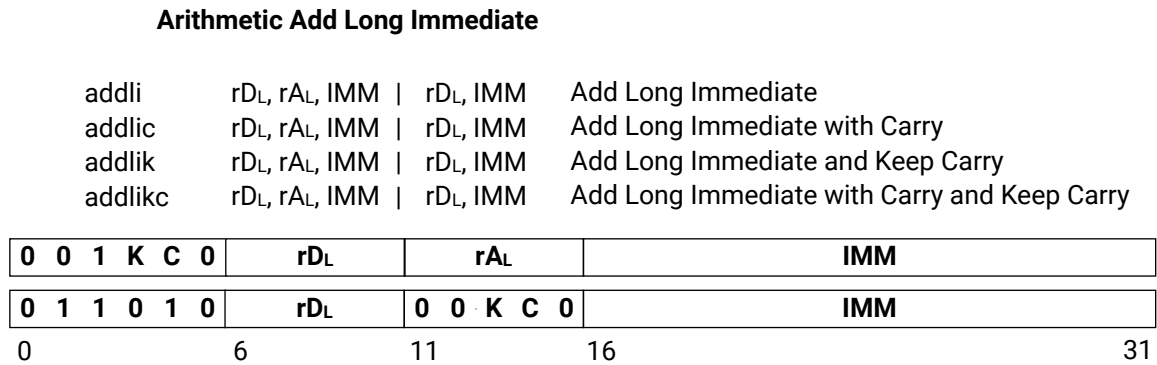
 Figure 146: **addli**

Description

The sum of the contents of registers rA_L or rD_L and the value in the IMM field extended with the immediate value from the preceding imml instructions, if any, is placed into register rD_L. Bit 3 or 13 of the instruction (labeled as K in the figure) is set to one for the mnemonic addlik. Bit 4 or 14 of the instruction (labeled as C in the figure) is set to one for the mnemonic addlic. Both bits are set to one for the mnemonic addlikc.

When an addli instruction has bit 3 or 13 set (addlik, addlikc), the carry flag will keep its previous value regardless of the outcome of the execution of the instruction. If bit 3 or 13 is cleared (addli, addlic), then the carry flag will be affected by the execution of the instruction.

When bit 4 or 14 of the instruction is set to one (addlic, addlikc), the content of the carry flag (MSR[C]) affects the execution of the instruction. When bit 4 or 14 is cleared (addli, addlik), the content of the carry flag does not affect the execution of the instruction (providing a normal addition).

Pseudocode

```

if C = 0 then
    (rDL) ← (rAL|rDL) + sext(IMM)
else
    (rDL) ← (rAL|rDL) + sext(IMM) + MSR[C]
if K = 0 then
    MSR[C] ← CarryOut64
    
```

Registers Altered

- rD_L
- MSR[C]

Latency

- 1 cycle

Notes

- The C bit in the instruction opcode is not the same as the carry bit in the MSR.
- Type B arithmetic long instructions with three operands must be preceded by an `imml` instruction. See the instruction [imml](#) for details on using long immediate values.

andl

Figure 147: andl



Description

The contents of register rA_L are ANDed with the contents of register rB_L; the result is placed into register rD_L.

Pseudocode

```
(rDL) ← (rAL) ∧ (rBL)
```

Registers Altered

- rD_L

Latency

- 1 cycle

andli

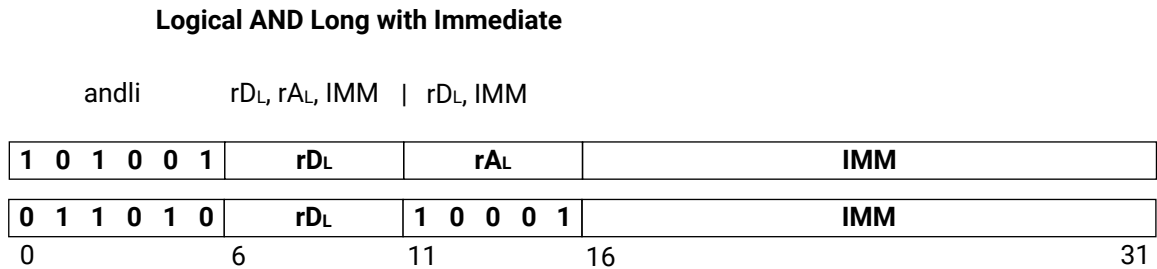
 Figure 148: **andli**

Description

The contents of register rA_L or rD_L are ANDed with the value of the IMM field extended with the immediate value from the preceding imml instructions; the result is placed into register rD_L.

Pseudocode

$$(rD_L) \leftarrow (rA_L | rD_L) \wedge \text{sext}(IMM)$$

Registers Altered

- rD_L

Latency

- 1 cycle

Note

- Type B logical long instructions with three operands must be preceded by an imml instruction. See the instruction [imml](#) for details on using long immediate values.

andnl

Figure 149: andnl



Description

The contents of register rA_L are ANDed with the logical complement of the contents of register rB_L; the result is placed into register rD_L.

Pseudocode

$$(rD_L) \leftarrow (rA_L) \wedge (\overline{rB_L})$$

Registers Altered

- rD_L

Latency

- 1 cycle

andnli

Figure 150: andnli

Logical AND NOT Long with Immediate

andnli rD_L, rA_L, IMM | rD_L, IMM

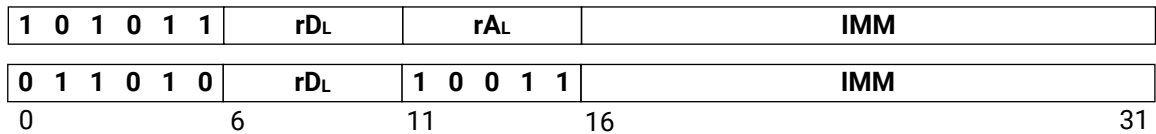

Description

The IMM field is sign-extended with the immediate value from the preceding immli instructions. The contents of register rA_L or rD_L are ANDed with the logical complement of the extended IMM field; the result is placed into register rD_L.

Pseudocode

$$(rD_L) \leftarrow (rA_L | rD_L) \wedge (\text{sext}(IMM))$$

Registers Altered

- rD_L

Latency

- 1 cycle

Note

- Type B logical long instructions with three operands must be preceded by an immli instruction. See the instruction [immli](#) for details on using long immediate values.

beaeq

Figure 151: beaeq

Branch Extended Address if Equal

beaeq	rA, rB _L	Branch Extended Address if Equal
bealeq	rA _L , rB _L	Branch Extended Address if Long Equal
beaeqd	rA, rB _L	Branch Extended Address if Equal with Delay
bealeqd	rA _L , rB _L	Branch Extended Address if Long Equal with Delay

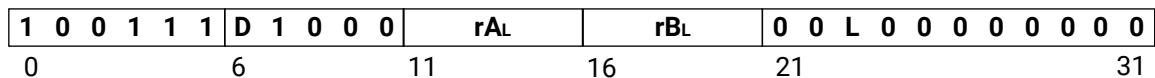

Description

Branch if rA or rA_L is equal to 0, to the instruction located in the offset value of rB_L. The target of the branch will be the instruction at address PC + rB_L.

The mnemonics bealeq and bealeqd set the L bit. If the L bit is set, a long comparison using rA_L is performed, otherwise a 32-bit comparison using rA is performed.

The mnemonics beaeqd and bealeqd set the D bit. The D bit determines whether there is a branch delay slot or not. If the D bit is set, it means that there is a delay slot and the instruction following the branch (that is, in the branch delay slot) is allowed to complete execution before executing the target instruction. If the D bit is not set, it means that there is no delay slot, so the instruction to be executed after the branch is the target instruction.

Pseudocode

```

if L = 1 and rAL = 0 then
    PC ← PC + rBL
else if rA = 0 then
    PC ← PC + rBL
else
    PC ← PC + 4
if D = 1 then
    allow following instruction to complete execution
    
```

Registers Altered

- PC

Latency

- 1 cycle (if branch is not taken)
- 2 cycles (if branch is taken and the D bit is set with C_AREA_OPTIMIZED≠2)

- 3 cycles (if branch is taken and the D bit is not set with `C_AREA_OPTIMIZED≠2`)
 - 6 cycles (if branch is taken and the D bit is set with `C_AREA_OPTIMIZED=2`)
 - 7 cycles (if branch is taken and the D bit is not set with `C_AREA_OPTIMIZED=2`)
- If `C_USE_MMU > 1` two additional cycles are added with `C_AREA_OPTIMIZED=2`.

Note

- A delay slot must not be used by the following: `imm`, `imml`, `branch`, or `break` instructions. Interrupts and external hardware breaks are deferred until after the delay slot branch has been completed.

beaeqi

Figure 152: **beaeqi**

Branch Extended Address Immediate if Equal

beaeqi rA, IMM Branch Extended Address immediate if Equal
 beaeqid rA, IMM Branch Extended Address Immediate if Equal with Delay

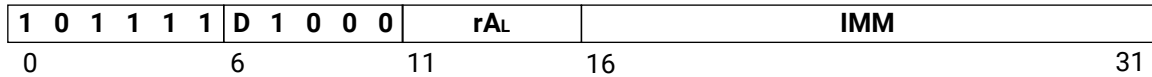

Description

Branch if rA or rA_L is equal to 0, to the instruction located in the offset value of IMM extended with the immediate value from the preceding imm or imml instructions. The target of the branch will be the instruction at address PC + IMM.

When preceded by an imml instruction, a long comparison using rA_L is performed, otherwise a 32-bit comparison using rA is performed.

The mnemonic beaeqid will set the D bit. The D bit determines whether there is a branch delay slot or not. If the D bit is set, it means that there is a delay slot and the instruction following the branch (that is, in the branch delay slot) is allowed to complete execution before executing the target instruction. If the D bit is not set, it means that there is no delay slot, so the instruction to be executed after the branch is the target instruction.

Pseudocode

```

If (preceded by imml) and rAL = 0 then
    PC ← PC + sext(IMM)
else if rA = 0 then
    PC ← PC + sext(IMM)
else
    PC ← PC + 4
if D = 1 then
    allow following instruction to complete execution
    
```

Registers Altered

- PC

Latency

- 1 cycle (if branch is not taken, or successful branch prediction occurs)
- 2 cycles (if branch is taken and the D bit is set with C_AREA_OPTIMIZED≠2)

- 3 cycles (if branch is taken and the D bit is not set with `C_AREA_OPTIMIZED≠2`, or a branch prediction mispredict occurs with `C_AREA_OPTIMIZED=0`)
- 6 cycles (if branch is taken and the D bit is set with `C_AREA_OPTIMIZED=2`)
- 7 cycles (if branch is taken and the D bit is not set, or if branch prediction mispredict occurs with `C_AREA_OPTIMIZED=2`)

If `C_USE_MMU > 1` two additional cycles are added with `C_AREA_OPTIMIZED=2`.

Notes

- By default, Type B Branch Long Instructions will take the 16-bit IMM field value and sign extend it to 64 bits to use as the immediate operand. This behavior can be overridden by preceding the Type B instruction with an `imm` or `imml` instruction. See the instructions [imm](#) and [imml](#) for details on using 64-bit immediate values.
- The assembler pseudo-instructions `bealeqi` and `bealeqid` are used to indicate a long comparison.

A delay slot must not be used by the following: `imm`, `imml`, branch, or break instructions. Interrupts and external hardware breaks are deferred until after the delay slot branch has been completed.

beage

Figure 153: **beage**

Branch Extended Address if Greater or Equal

beage	rA, rBL	Branch Extended Address if Greater or Equal
bealge	rAL, rBL	Branch Extended Address if Long Greater or Equal
beaged	rA, rBL	Branch Extended Address if Greater or Equal with Delay
bealged	rAL, rBL	Branch Extended Address if Long Greater or Equal with Delay

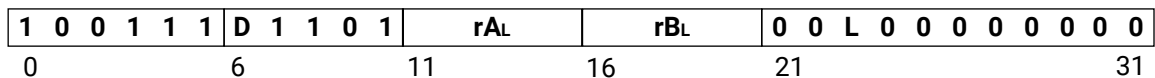

Description

Branch if rA or rAL is greater or equal to 0, to the instruction located in the offset value of rBL. The target of the branch will be the instruction at address PC + rBL.

The mnemonics bealge and bealged will set the L bit. If the L bit is set, a long comparison using rAL is performed, otherwise a 32-bit comparison using rA is performed.

The mnemonics beaged and bealged will set the D bit. The D bit determines whether there is a branch delay slot or not. If the D bit is set, it means that there is a delay slot and the instruction following the branch (that is, in the branch delay slot) is allowed to complete execution before executing the target instruction. If the D bit is not set, it means that there is no delay slot, so the instruction to be executed after the branch is the target instruction.

Pseudocode

```

if L = 1 and rAL >= 0 then
    PC ← PC + rBL
else if rA >= 0 then
    PC ← PC + rBL
else
    PC ← PC + 4
if D = 1 then
    allow following instruction to complete execution
    
```

Registers Altered

- PC

Latency

- 1 cycle (if branch is not taken)
- 2 cycles (if branch is taken and the D bit is set with C_AREA_OPTIMIZED≠2)

- 3 cycles (if branch is taken and the D bit is not set with `C_AREA_OPTIMIZED≠2`)
- 6 cycles (if branch is taken and the D bit is set with `C_AREA_OPTIMIZED=2`)
- 7 cycles (if branch is taken and the D bit is not set with `C_AREA_OPTIMIZED=2`)

If `C_USE_MMU > 1` two additional cycles are added with `C_AREA_OPTIMIZED=2`.

Notes

- A delay slot must not be used by the following: `imm`, `imml`, `branch`, or `break` instructions. Interrupts and external hardware breaks are deferred until after the delay slot branch has been completed.

beagei

Figure 154: **beagei**

Branch Extended Address Immediate if Greater or Equal

beagei rA, IMM Branch Extended Address Immediate if Greater or Equal
 beageid rA, IMM Branch Extended Address Immediate if Greater or Equal with Delay

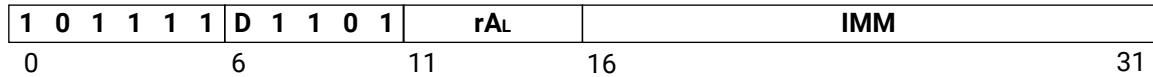

Description

Branch if rA or rA_L is greater or equal to 0, to the instruction located in the offset value of IMM extended with the immediate value from the preceding imm or imml instructions. The target of the branch will be the instruction at address PC + IMM.

When preceded by an imml instruction, a long comparison using rA_L is performed, otherwise a 32-bit comparison using rA is performed.

The mnemonic beageid will set the D bit. The D bit determines whether there is a branch delay slot or not. If the D bit is set, it means that there is a delay slot and the instruction following the branch (that is, in the branch delay slot) is allowed to complete execution before executing the target instruction. If the D bit is not set, it means that there is no delay slot, so the instruction to be executed after the branch is the target instruction.

Pseudocode

```

If (preceded by imml) and rAL = 0 then
    PC ← PC + sext(IMM)
else if rA >= 0 then
    PC ← PC + sext(IMM)
else
    PC ← PC + 4
if D = 1 then
    allow following instruction to complete execution
    
```

Registers Altered

- PC

Latency

- 1 cycle (if branch is not taken, or successful branch prediction occurs)
- 2 cycles (if branch is taken and the D bit is set with C_AREA_OPTIMIZED≠2)

- 3 cycles (if branch is taken and the D bit is not set with `C_AREA_OPTIMIZED≠2`, or a branch prediction mispredict occurs with `C_AREA_OPTIMIZED=0`)
- 6 cycles (if branch is taken and the D bit is set with `C_AREA_OPTIMIZED=2`)
- 7 cycles (if branch is taken and the D bit is not set, or if branch prediction mispredict occurs with `C_AREA_OPTIMIZED=2`)

If `C_USE_MMU > 1` two additional cycles are added with `C_AREA_OPTIMIZED=2`.

Notes

- By default, Type B Branch Long Instructions will take the 16-bit IMM field value and sign extend it to 64 bits to use as the immediate operand. This behavior can be overridden by preceding the Type B instruction with an `imm` or `imml` instruction. See the instructions [imm](#) and [imml](#) for details on using 64-bit immediate values.
- The assembler pseudo-instructions `bealgei` and `bealgeid` are used to indicate a long comparison.
- A delay slot must not be used by the following: `imm`, `imml`, `branch`, or `break` instructions. Interrupts and external hardware breaks are deferred until after the delay slot branch has been completed.

beagt

Figure 155: beagt

Branch Extended Address if Greater Than

beagt	rA, rBL	Branch Extended Address if Greater Than
bealgt	rAL, rBL	Branch Extended Address if Long Greater Than
beagtd	rA, rBL	Branch Extended Address if Greater Than with Delay
bealgtD	rAL, rBL	Branch Extended Address if Long Greater Than with Delay

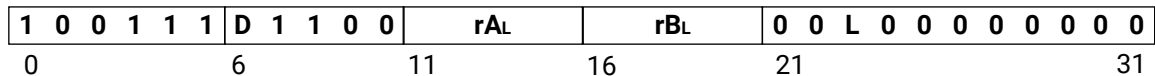

Description

Branch if rA or rAL is greater than 0, to the instruction located in the offset value of rBL. The target of the branch will be the instruction at address PC + rBL.

The mnemonics bealgt and bealgtD will set the L bit. If the L bit is set, a long comparison using rAL is performed, otherwise a 32-bit comparison using rA is performed.

The mnemonics beagtd and bealgtD will set the D bit. The D bit determines whether there is a branch delay slot or not. If the D bit is set, it means that there is a delay slot and the instruction following the branch (that is, in the branch delay slot) is allowed to complete execution before executing the target instruction. If the D bit is not set, it means that there is no delay slot, so the instruction to be executed after the branch is the target instruction.

Pseudocode

```

if L = 1 and rAL > 0 then
    PC ← PC + rBL
else if rA > 0 then
    PC ← PC + rBL
else
    PC ← PC + 4
if D = 1 then
    allow following instruction to complete execution
    
```

Registers Altered

- PC

Latency

- 1 cycle (if branch is not taken)
- 2 cycles (if branch is taken and the D bit is set with C_AREA_OPTIMIZED≠2)

- 3 cycles (if branch is taken and the D bit is not set with `C_AREA_OPTIMIZED≠2`)
- 6 cycles (if branch is taken and the D bit is set with `C_AREA_OPTIMIZED=2`)
- 7 cycles (if branch is taken and the D bit is not set with `C_AREA_OPTIMIZED=2`)

If `C_USE_MMU > 1` two additional cycles are added with `C_AREA_OPTIMIZED=2`.

Note

- A delay slot must not be used by the following: `imm`, `imml`, `branch`, or `break` instructions. Interrupts and external hardware breaks are deferred until after the delay slot branch has been completed.

beagti

Figure 156: **beagti**

Branch Extended Address Immediate if Greater Than

beagti	rA, IMM	Branch Extended Address Immediate if Greater Than
beagtid	rA, IMM	Branch Extended Address Immediate if Greater Than with Delay

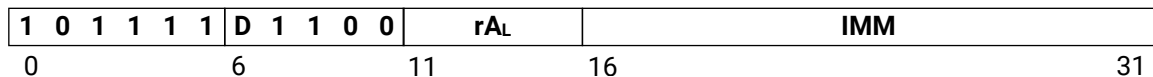

Description

Branch if rA or rA_L is greater than 0, to the instruction located in the offset value of IMM extended with the immediate value from the preceding imm or imm1 instructions. The target of the branch will be the instruction at address PC + IMM.

When preceded by an imm1 instruction, a long comparison using rA_L is performed, otherwise a 32-bit comparison using rA is performed.

The mnemonic beagtid will set the D bit. The D bit determines whether there is a branch delay slot or not. If the D bit is set, it means that there is a delay slot and the instruction following the branch (that is, in the branch delay slot) is allowed to complete execution before executing the target instruction. If the D bit is not set, it means that there is no delay slot, so the instruction to be executed after the branch is the target instruction.

Pseudocode

```

If (preceded by imm1) and rAL > 0 then
    PC ← PC + sext(IMM)
else if rA > 0 then
    PC ← PC + sext(IMM)
else
    PC ← PC + 4
if D = 1 then
    allow following instruction to complete execution
  
```

Registers Altered

- PC

Latency

- 1 cycle (if branch is not taken, or successful branch prediction occurs)
- 2 cycles (if branch is taken and the D bit is set with C_AREA_OPTIMIZED≠2)

- 3 cycles (if branch is taken and the D bit is not set with `C_AREA_OPTIMIZED≠2`, or a branch prediction mispredict occurs with `C_AREA_OPTIMIZED=0`)
- 6 cycles (if branch is taken and the D bit is set with `C_AREA_OPTIMIZED=2`)
- 7 cycles (if branch is taken and the D bit is not set, or if branch prediction mispredict occurs with `C_AREA_OPTIMIZED=2`)

If `C_USE_MMU > 1` two additional cycles are added with `C_AREA_OPTIMIZED=2`.

Notes

- By default, Type B Branch Long Instructions will take the 16-bit IMM field value and sign extend it to 64 bits to use as the immediate operand. This behavior can be overridden by preceding the Type B instruction with an `imm` or `imml` instruction. See the instructions [imm](#) and [imml](#) for details on using 64-bit immediate values.

The assembler pseudo-instructions `bealgti` and `bealgtid` are used to indicate a long comparison.

A delay slot must not be used by the following: `imm`, `imml`, `branch`, or `break` instructions. Interrupts and external hardware breaks are deferred until after the delay slot branch has been completed.

beale

Figure 157: beale

Branch Extended Address if Less or Equal

beale	rA, rBL	Branch Extended Address if Less or Equal
bealle	rAL, rBL	Branch Extended Address if Long Less or Equal
bealed	rA, rBL	Branch Extended Address if Less or Equal with Delay
bealled	rAL, rBL	Branch Extended Address if Long Less or Equal with Delay

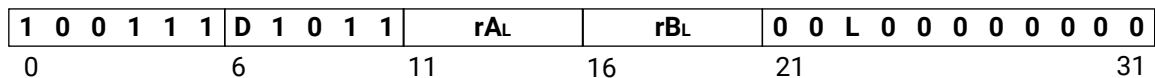

Description

Branch if rA or rAL is less or equal to 0, to the instruction located in the offset value of rBL. The target of the branch will be the instruction at address PC + rBL.

The mnemonics bealle and bealled will set the L bit. If the L bit is set, a long comparison using rAL is performed, otherwise a 32-bit comparison using rA is performed.

The mnemonics bealed and bealled will set the D bit. The D bit determines whether there is a branch delay slot or not. If the D bit is set, it means that there is a delay slot and the instruction following the branch (that is, in the branch delay slot) is allowed to complete execution before executing the target instruction. If the D bit is not set, it means that there is no delay slot, so the instruction to be executed after the branch is the target instruction.

Pseudocode

```

if L = 1 and rAL <= 0 then
    PC ← PC + rBL
else if rA <= 0 then
    PC ← PC + rBL
else
    PC ← PC + 4
if D = 1 then
    allow following instruction to complete execution
    
```

Registers Altered

- PC

Latency

- 1 cycle (if branch is not taken)
- 2 cycles (if branch is taken and the D bit is set with C_AREA_OPTIMIZED≠2)

- 3 cycles (if branch is taken and the D bit is not set with `C_AREA_OPTIMIZED≠2`)
- 6 cycles (if branch is taken and the D bit is set with `C_AREA_OPTIMIZED=2`)
- 7 cycles (if branch is taken and the D bit is not set with `C_AREA_OPTIMIZED=2`)

If `C_USE_MMU > 1` two additional cycles are added with `C_AREA_OPTIMIZED=2`.

Note

- A delay slot must not be used by the following: `imm`, `imml`, `branch`, or `break` instructions. Interrupts and external hardware breaks are deferred until after the delay slot branch has been completed.

bealei

Figure 158: **bealei**

Branch Extended Address Immediate if Less or Equal

bealei	rA, IMM	Branch Extended Address Immediate if Less or Equal
bealeid	rA, IMM	Branch Extended Address if Immediate if Less or Equal with Delay

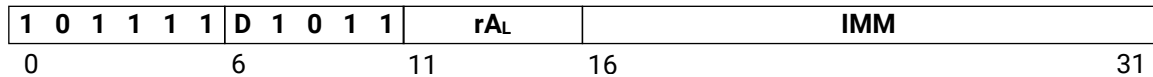

Description

Branch if rA or rA_L is less or equal to 0, to the instruction located in the offset value of IMM extended with the immediate value from the preceding imm or imm1 instructions. The target of the branch will be the instruction at address PC + IMM.

When preceded by an imm1 instruction, a long comparison using rA_L is performed, otherwise a 32-bit comparison using rA is performed.

The mnemonic bealeid will set the D bit. The D bit determines whether there is a branch delay slot or not. If the D bit is set, it means that there is a delay slot and the instruction following the branch (that is, in the branch delay slot) is allowed to complete execution before executing the target instruction. If the D bit is not set, it means that there is no delay slot, so the instruction to be executed after the branch is the target instruction.

Pseudocode

```

If (preceded by imm1) and rAL <= 0 then
    PC ← PC + sext(IMM)
else if rA <= 0 then
    PC ← PC + sext(IMM)
else
    PC ← PC + 4
if D = 1 then
    allow following instruction to complete execution
  
```

Registers Altered

- PC

Latency

- 1 cycle (if branch is not taken, or successful branch prediction occurs)
- 2 cycles (if branch is taken and the D bit is set with C_AREA_OPTIMIZED≠2)

- 3 cycles (if branch is taken and the D bit is not set with `C_AREA_OPTIMIZED≠2`, or a branch prediction mispredict occurs with `C_AREA_OPTIMIZED=0`)
- 6 cycles (if branch is taken and the D bit is set with `C_AREA_OPTIMIZED=2`)
- 7 cycles (if branch is taken and the D bit is not set, or if branch prediction mispredict occurs with `C_AREA_OPTIMIZED=2`)

If `C_USE_MMU > 1` two additional cycles are added with `C_AREA_OPTIMIZED=2`.

Notes

- By default, Type B Branch Long Instructions will take the 16-bit IMM field value and sign extend it to 64 bits to use as the immediate operand. This behavior can be overridden by preceding the Type B instruction with an `imm` or `imml` instruction. See the instructions [imm](#) and [imml](#) for details on using 64-bit immediate values.
- The assembler pseudo-instructions `beallei` and `bealleid` are used to indicate a long comparison.
- A delay slot must not be used by the following: `imm`, `imml`, `branch`, or `break` instructions. Interrupts and external hardware breaks are deferred until after the delay slot branch has been completed.

bealt

Figure 159: **bealt**

Branch Extended Address if Less Than

bealt	rA, rBL	Branch Extended Address if Less Than
beallt	rAL, rBL	Branch Extended Address if Long Less Than
bealtd	rA, rBL	Branch Extended Address if Less Than with Delay
bealtd	rAL, rBL	Branch Extended Address if Long Less Than with Delay

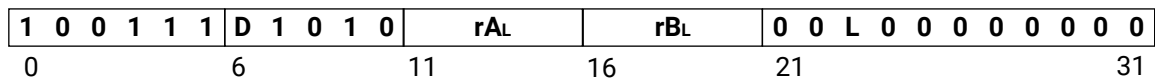

Description

Branch if rA or rA_L is less than 0, to the instruction located in the offset value of rB_L . The target of the branch will be the instruction at address $PC + rB_L$.

The mnemonics beallt and bealtd will set the L bit. If the L bit is set, a long comparison using rA_L is performed, otherwise a 32-bit comparison using rA is performed.

The mnemonics bealtd and bealtd will set the D bit. The D bit determines whether there is a branch delay slot or not. If the D bit is set, it means that there is a delay slot and the instruction following the branch (that is, in the branch delay slot) is allowed to complete execution before executing the target instruction. If the D bit is not set, it means that there is no delay slot, so the instruction to be executed after the branch is the target instruction.

Pseudocode

```

if L = 1 and  $rA_L < 0$  then
    PC ← PC +  $rB_L$ 
else if rA < 0 then
    PC ← PC +  $rB_L$ 
else
    PC ← PC + 4
if D = 1 then
    allow following instruction to complete execution
    
```

Registers Altered

- PC

Latency

- 1 cycle (if branch is not taken)
- 2 cycles (if branch is taken and the D bit is set with `C_AREA_OPTIMIZED#2`)

- 3 cycles (if branch is taken and the D bit is not set with `C_AREA_OPTIMIZED≠2`)
- 6 cycles (if branch is taken and the D bit is set with `C_AREA_OPTIMIZED=2`)
- 7 cycles (if branch is taken and the D bit is not set with `C_AREA_OPTIMIZED=2`)

If `C_USE_MMU > 1` two additional cycles are added with `C_AREA_OPTIMIZED=2`.

Notes

- A delay slot must not be used by the following: `imm`, `imml`, `branch`, or `break` instructions. Interrupts and external hardware breaks are deferred until after the delay slot branch has been completed.

bealti

Figure 160: **bealti**

Branch Extended Address Immediate if Less Than

bealti	rA, IMM	Branch Extended Address Immediate if Less Than
bealtid	rA, IMM	Branch Extended Address Immediate if Less Than with Delay

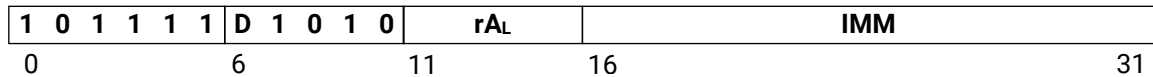

Description

Branch if rA or rA_L is less than 0, to the instruction located in the offset value of IMM extended with the immediate value from the preceding imm or imm1 instructions. The target of the branch will be the instruction at address PC + IMM.

When preceded by an imm1 instruction, a long comparison using rA_L is performed, otherwise a 32-bit comparison using rA is performed.

The mnemonic bealtid will set the D bit. The D bit determines whether there is a branch delay slot or not. If the D bit is set, it means that there is a delay slot and the instruction following the branch (that is, in the branch delay slot) is allowed to complete execution before executing the target instruction. If the D bit is not set, it means that there is no delay slot, so the instruction to be executed after the branch is the target instruction.

Pseudocode

```

If (preceded by imm1) and rAL < 0 then
    PC ← PC + sext(IMM)
else if rA < 0 then
    PC ← PC + sext(IMM)
else
    PC ← PC + 4
if D = 1 then
    allow following instruction to complete execution
  
```

Registers Altered

- PC

Latency

- 1 cycle (if branch is not taken, or successful branch prediction occurs)
- 2 cycles (if branch is taken and the D bit is set with C_AREA_OPTIMIZED≠2)

- 3 cycles (if branch is taken and the D bit is not set with `C_AREA_OPTIMIZED≠2`, or a branch prediction mispredict occurs with `C_AREA_OPTIMIZED=0`)
- 6 cycles (if branch is taken and the D bit is set with `C_AREA_OPTIMIZED=2`)
- 7 cycles (if branch is taken and the D bit is not set, or if branch prediction mispredict occurs with `C_AREA_OPTIMIZED=2`)

If `C_USE_MMU > 1` two additional cycles are added with `C_AREA_OPTIMIZED=2`.

Notes

- By default, Type B Branch Long Instructions will take the 16-bit IMM field value and sign extend it to 64 bits to use as the immediate operand. This behavior can be overridden by preceding the Type B instruction with an `imm` or `imml` instruction. See the instructions [imm](#) and [imml](#) for details on using 64-bit immediate values.
- The assembler pseudo-instructions `beallti` and `bealltid` are used to indicate a long comparison.
- A delay slot must not be used by the following: `imm`, `imml`, `branch`, or `break` instructions. Interrupts and external hardware breaks are deferred until after the delay slot branch has been completed.

beane

Figure 161: **beane**

Branch Extended Address if Not Equal

beane	rA, rB _L	Branch Extended Address if Not Equal
bealne	rA _L , rB _L	Branch Extended Address if Long Not Equal
beaned	rA, rB _L	Branch Extended Address if Not Equal with Delay
bealned	rA _L , rB _L	Branch Extended Address if Long Not Equal with Delay

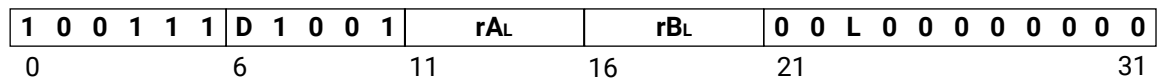

Description

Branch if rA or rA_L is not equal to 0, to the instruction located in the offset value of rB_L. The target of the branch will be the instruction at address PC + rB_L.

The mnemonics bealne and bealned will set the L bit. If the L bit is set, a long comparison using rA_L is performed, otherwise a 32-bit comparison using rA is performed.

The mnemonics beaned and bealned will set the D bit. The D bit determines whether there is a branch delay slot or not. If the D bit is set, it means that there is a delay slot and the instruction following the branch (that is, in the branch delay slot) is allowed to complete execution before executing the target instruction. If the D bit is not set, it means that there is no delay slot, so the instruction to be executed after the branch is the target instruction.

Pseudocode

```

if L = 1 and rAL ≠ 0 then
    PC ← PC + rBL
else if rA ≠ 0 then
    PC ← PC + rBL
else
    PC ← PC + 4
if D = 1 then
    allow following instruction to complete execution
    
```

Registers Altered

- PC

Latency

- 1 cycle (if branch is not taken)
- 2 cycles (if branch is taken and the D bit is set with C_AREA_OPTIMIZED≠2)

- 3 cycles (if branch is taken and the D bit is not set with `C_AREA_OPTIMIZED≠2`)
- 6 cycles (if branch is taken and the D bit is set with `C_AREA_OPTIMIZED=2`)
- 7 cycles (if branch is taken and the D bit is not set with `C_AREA_OPTIMIZED=2`)

If `C_USE_MMU > 1` two additional cycles are added with `C_AREA_OPTIMIZED=2`.

Notes

- A delay slot must not be used by the following: `imm`, `imml`, `branch`, or `break` instructions. Interrupts and external hardware breaks are deferred until after the delay slot branch has been completed.

beanei

Figure 162: **beanei**

Branch Extended Address Immediate if Not Equal

beanei	rA, IMM	Branch Extended Address Immediate if not Equal
beaneid	rA, IMM	Branch Extended Address Immediate if Not Equal with Delay

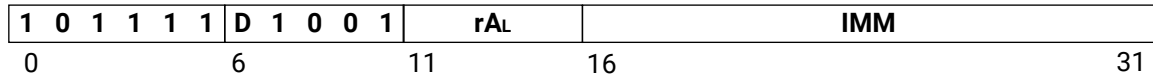

Description

Branch if rA or rA_L is not equal to 0, to the instruction located in the offset value of IMM extended with the immediate value from the preceding imm or imm1 instructions. The target of the branch will be the instruction at address PC + IMM.

When preceded by an imm1 instruction, a long comparison using rA_L is performed, otherwise a 32-bit comparison using rA is performed.

The mnemonic beaneid will set the D bit. The D bit determines whether there is a branch delay slot or not. If the D bit is set, it means that there is a delay slot and the instruction following the branch (that is, in the branch delay slot) is allowed to complete execution before executing the target instruction. If the D bit is not set, it means that there is no delay slot, so the instruction to be executed after the branch is the target instruction.

Pseudocode

```

If (preceded by imm1) and rAL ≠ 0 then
    PC ← PC + sext(IMM)
else if rA ≠ 0 then
    PC ← PC + sext(IMM)
else
    PC ← PC + 4
if D = 1 then
    allow following instruction to complete execution
    
```

Registers Altered

- PC

Latency

- 1 cycle (if branch is not taken, or successful branch prediction occurs)
- 2 cycles (if branch is taken and the D bit is set with C_AREA_OPTIMIZED≠2)

- 3 cycles (if branch is taken and the D bit is not set with `C_AREA_OPTIMIZED≠2`, or a branch prediction mispredict occurs with `C_AREA_OPTIMIZED=0`)
- 6 cycles (if branch is taken and the D bit is set with `C_AREA_OPTIMIZED=2`)
- 7 cycles (if branch is taken and the D bit is not set, or if branch prediction mispredict occurs with `C_AREA_OPTIMIZED=2`)

If `C_USE_MMU > 1` two additional cycles are added with `C_AREA_OPTIMIZED=2`.

Notes

- By default, Type B Branch Long Instructions will take the 16-bit IMM field value and sign extend it to 64 bits to use as the immediate operand. This behavior can be overridden by preceding the Type B instruction with an `imm` or `imml` instruction. See the instructions [imm](#) and [imml](#) for details on using 64-bit immediate values.

The assembler pseudo-instructions `bealnei` and `bealneid` are used to indicate a long comparison.

A delay slot must not be used by the following: `imm`, `imml`, `branch`, or `break` instructions. Interrupts and external hardware breaks are deferred until after the delay slot branch has been completed.

bre

Figure 163: bre

Unconditional Branch Extended Address

bre	rB _L	Branch Extended Address
bread	rB _L	Branch Extended Address with Delay
breald	rD _L , rB _L	Branch Extended Address and Link with Delay

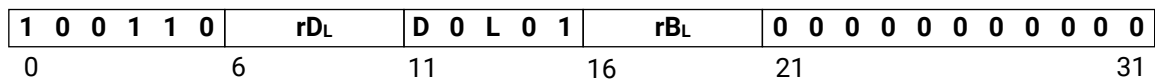

Description

Branch to the instruction located at address determined by PC + rB_L.

The mnemonic breald will set the L bit. If the L bit is set, linking will be performed. The current value of PC will be stored in rD_L.

The mnemonics bread and breald will set the D bit. The D bit determines whether there is a branch delay slot or not. If the D bit is set, it means that there is a delay slot and the instruction following the branch (that is, in the branch delay slot) is allowed to complete execution before executing the target instruction.

If the D bit is not set, it means that there is no delay slot, so the instruction to be executed after the branch is the target instruction.

Pseudocode

```

if L = 1 then
    (rDL) ← PC
PC ← PC + (rBL)
if D = 1 then
    allow following instruction to complete execution
    
```

Registers Altered

- rD_L
- PC

Latency

- 2 cycles (if the D bit is set with C_AREA_OPTIMIZED≠2)
- 3 cycles (if the D bit is not set with C_AREA_OPTIMIZED≠2)
- 6 cycles (if the D bit is set with C_AREA_OPTIMIZED=2)

- 7 cycles (if the D bit is not set with `C_AREA_OPTIMIZED=2`)

If `C_USE_MMU > 1` two additional cycles are added with `C_AREA_OPTIMIZED=2`.

Notes

- The instruction breal is not available.
- Absolute extended address branches can be performed with the instructions bra, brad, and brald.
- A delay slot must not be used by the following: imm, imml, branch, or break instructions. Interrupts and external hardware breaks are deferred until after the delay slot branch has been completed.

breai

Figure 164: **breai**

Unconditional Branch Extended Address Immediate

breai	IMM	Branch Extended Address Immediate
breaid	IMM	Branch Extended Address Immediate with Delay
brealid	rD _L , IMM	Branch Extended Address and Link Immediate with Delay

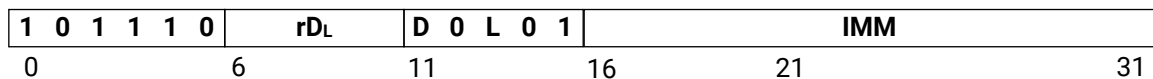

Description

Branch to the instruction located at address determined by PC + IMM, extended with the immediate value from the preceding IMM or imml instructions.

The mnemonic `brealid` will set the L bit. If the L bit is set, linking will be performed. The current value of PC will be stored in rD_L.

The mnemonics `breaid` and `brealid` will set the D bit. The D bit determines whether there is a branch delay slot or not. If the D bit is set, it means that there is a delay slot and the instruction following the branch (that is, in the branch delay slot) is allowed to complete execution before executing the target instruction. If the D bit is not set, it means that there is no delay slot, so the instruction to be executed after the branch is the target instruction.

Pseudocode

```

if L = 1 then
    (rDL) ← PC
PC ← PC + sext(IMM)
if D = 1 then
    allow following instruction to complete execution
    
```

Registers Altered

- rD_L
- PC

Latency

- 1 cycle (if successful branch prediction occurs)
- 2 cycles (if the D bit is set with C_AREA_OPTIMIZED≠2)
- 3 cycles (if the D bit is not set with C_AREA_OPTIMIZED≠2, or a branch prediction mispredict occurs with C_AREA_OPTIMIZED=0)

- 6 cycles (if the D bit is set with `C_AREA_OPTIMIZED=2`)
- 7 cycles (if the D bit is not set, or if branch prediction mispredict occurs with `C_AREA_OPTIMIZED=2`)

If `C_USE_MMU > 1` two additional cycles are added with `C_AREA_OPTIMIZED=2`.

Notes

- The instruction `breali` is not available.
- Absolute extended address branches can be performed with the instructions `brai`, `braid`, and `bralid`.
- By default, Type B Branch Long Instructions will take the 16-bit IMM field value and sign extend it to 64 bits to use as the immediate operand. This behavior can be overridden by preceding the Type B instruction with an `imm` or `imml` instruction. See the instructions [imm](#) and [imml](#) for details on using 64-bit immediate values.
- A delay slot must not be used by the following: `imm`, `imml`, `branch`, or `break` instructions. Interrupts and external hardware breaks are deferred until after the delay slot branch has been completed.

Notes

- These instructions are optional. To use them, MicroBlaze has to be configured to use barrel shift instructions (`C_USE_BARREL=1`).

bsli

Figure 166: bsli

Barrel Shift Long Immediate

bslrli	rD _L , rA _L , IMM	Barrel Shift Long Right Logical Immediate
bslrai	rD _L , rA _L , IMM	Barrel Shift Long Right Arithmetic Immediate
bsllli	rD _L , rA _L , IMM	Barrel Shift Long Left Logical Immediate
bslefi	rD _L , rA _L , IMM _W , IMM _S	Barrel Shift Long Extract Field Immediate
bslifi	rD _L , rA _L , Width ¹ , IMM _S	Barrel Shift Long Insert Field Immediate

1. Width = IMM_W - IMM_S + 1

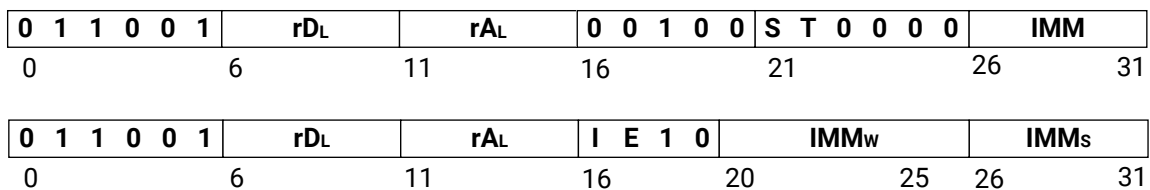

Description

The first three instructions shift the contents of register rA_L by the amount specified by IMM and put the result in register rD_L.

Barrel Shift Extract Field extracts a bit field from register rA_L and puts the result in register rD_L. The bit field width is specified by IMM_W and the shift amount is specified by IMM_S. The bit field width must be in the range 1 - 63, and the condition IMM_W + IMM_S ≤ 64 must apply.

Barrel Shift Insert Field inserts a bit field from register rA_L into register rD_L, modifying the existing value in register rD_L. The bit field width is defined by IMM_W - IMM_S + 1, and the shift amount is specified by IMM_S. The condition IMM_W ≥ IMM_S must apply.

The mnemonic bsllli sets the S bit (Side bit). If the S bit is set, the barrel shift is done to the left. The mnemonics bslrli and bslrai clear the S bit and the shift is done to the right.

The mnemonic bslrai sets the T bit (Type bit). If the T bit is set, the barrel shift performed is Arithmetical. The mnemonics bslrli and bsllli clear the T bit and the shift performed is Logical.

The mnemonic bslefi sets the E bit (Extract bit). In this case the S and T bits are not used.

The mnemonic bslifi sets the I bit (Insert bit). In this case the S and T bits are not used.

Pseudocode

```

if E = 1 then
    (rDL)[0:63-IMMW] ← 0
    (rDL)[64-IMMW:63] ← (rAL) >> IMMS
else if I = 1 then
    mask ← (0xffffffffffffffff << (IMMW + 1)) ⊕ (0xffffffffffffffff << IMMS)
    (rDL) ← ((rAL) << IMMS) ∧ mask ∨ ((rDL) ∧ mask)
else if S = 1 then
    (rDL) ← (rAL) << IMM
else if T = 1 then
    if IMM ≠ 0 then
        (rDL)[0:IMM-1] ← (rAL)[0]
        (rDL)[IMM:31] ← (rAL) >> IMM
    else
        (rDL) ← (rAL)
else
    (rDL) ← (rAL) >> IMM

```

Registers Altered

- rD_L

Latency

- 1 cycle with C_AREA_OPTIMIZED=0 or 2
- 2 cycles with C_AREA_OPTIMIZED=1

Notes

- These are not Type B Instructions. There is no effect from a preceding imm or immI instruction.
- These instructions are optional. To use them, MicroBlaze has to be configured to use barrel shift instructions (C_USE_BARREL=1).
- The assembler code “bslifi rD, rA, width, shift” denotes the actual bit field width, not the IMM_W field, which is computed by IMM_W = shift + width - 1.

cmpl

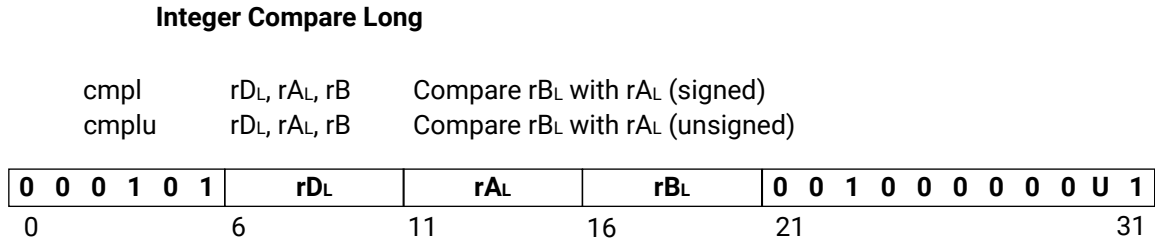
 Figure 167: **cmpl**

Description

The contents of register rA_L are subtracted from the contents of register rB_L and the result is placed into register rD_L.

The MSB bit of rD_L is adjusted to show true relation between rA_L and rB_L. If the U bit is set, rA_L and rB_L is considered unsigned values. If the U bit is clear, rA_L and rB_L is considered signed values.

Pseudocode

$$\begin{aligned}
 (rD_L) &\leftarrow (rB_L) + (\overline{rA_L}) + 1 \\
 (rD_L)(MSB) &\leftarrow (rA_L) > (rB_L)
 \end{aligned}$$

Registers Altered

- rD_L

Latency

- 1 cycle

dadd

Figure 168: dadd

Double Floating-Point Arithmetic Add

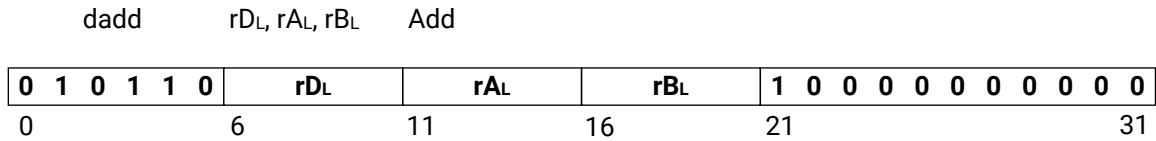

Description

The double precision floating-point sum of registers rA_L and rB_L, is placed into register rD_L.

Pseudocode

```

if isDnz(rAL) or isDnz(rBL) then
    (rDL) ← 0xFFF8000000000000
    FSR[DO] ← 1
    ESR[EC] ← 00110
else if isSigNaN(rAL) or isSigNaN(rBL) or
    (isPosInfinite(rAL) and isNegInfinite(rBL)) or
    (isNegInfinite(rAL) and isPosInfinite(rBL)) then
    (rDL) ← 0xFFF8000000000000
    FSR[IO] ← 1
    ESR[EC] ← 00110
else if isQuietNaN(rAL) or isQuietNaN(rBL) then
    (rDL) ← 0xFFF8000000000000
else if isDnz((rAL)+(rBL)) then
    (rDL) ← signZero((rAL)+(rBL))
    FSR[UF] ← 1
    ESR[EC] ← 00110
else if isNaN((rAL)+(rBL)) then
    (rDL) ← signInfinite((rAL)+(rBL))
    FSR[OF] ← 1
    ESR[EC] ← 00110
else
    (rDL) ← (rAL) + (rBL)
    
```

Registers Altered

- rD_L, unless an FP exception is generated, in which case the register is unchanged
- ESR[EC], if an FP exception is generated
- FSR[IO,UF,OF,DO]

Latency

- 4 cycles with C_AREA_OPTIMIZED=0
- 6 cycles with C_AREA_OPTIMIZED=1

- 1 cycle with `C_AREA_OPTIMIZED=2`

Notes

- This instruction is only available when the MicroBlaze parameter `C_USE_FPU` is greater than 0.

drsub

Figure 169: drsub

Double Reverse Floating-Point Arithmetic Subtraction

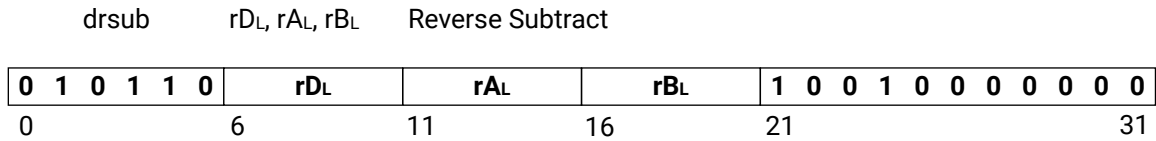

Description

The double precision floating-point value in rAL is subtracted from the double floating-point value in rBL and the result is placed into register rDL.

Pseudocode

```

if isDnz(rAL) or isDnz(rBL) then
    (rDL) ← 0xFFF8000000000000
    FSR[DO] ← 1
    ESR[EC] ← 00110
else if (isSigNaN(rAL) or isSigNaN(rBL) or
        (isPosInfinite(rAL) and isPosInfinite(rBL)) or
        (isNegInfinite(rAL) and isNegInfinite(rBL))) then
    (rDL) ← 0xFFF8000000000000
    FSR[IO] ← 1
    ESR[EC] ← 00110
else if isQuietNaN(rAL) or isQuietNaN(rBL) then
    (rDL) ← 0xFFF8000000000000
else if isDnz((rBL)-(rAL)) then
    (rDL) ← signZero((rBL)-(rAL))
    FSR[UF] ← 1
    ESR[EC] ← 00110
else if isNaN((rBL)-(rAL)) then
    (rDL) ← signInfinite((rBL)-(rAL))
    FSR[OF] ← 1
    ESR[EC] ← 00110
else
    (rDL) ← (rBL) - (rAL)
    
```

Registers Altered

- rDL, unless an FP exception is generated, in which case the register is unchanged
- ESR[EC], if an FP exception is generated
- FSR[IO,UF,OF,DO]

Latency

- 4 cycles with C_AREA_OPTIMIZED=0

- 6 cycles with `C_AREA_OPTIMIZED=1`
- 1 cycle with `C_AREA_OPTIMIZED=2`

Notes

- This instruction is only available when the MicroBlaze parameter `C_USE_FPU` is greater than 0.

dmul

Figure 170: dmul

Double Floating-Point Arithmetic Multiplication



Description

The double precision floating-point value in rA_L is multiplied with the double floating-point value in rB_L and the result is placed into register rD_L.

Pseudocode

```

if isDnz(rAL) or isDnz(rBL) then
    (rDL) ← 0xFFF8000000000000
    FSR[DO] ← 1
    ESR[EC] ← 00110
else
    if isSigNaN(rAL) or isSigNaN(rBL) or (isZero(rAL) and isInfinite(rBL)) or
        (isZero(rBL) and isInfinite(rAL)) then
        (rDL) ← 0xFFF8000000000000
        FSR[IO] ← 1
        ESR[EC] ← 00110
    else if isQuietNaN(rAL) or isQuietNaN(rBL) then
        (rDL) ← 0xFFF8000000000000
    else if isDnz((rBL)*(rAL)) then
        (rDL) ← signZero((rAL)*(rBL))
        FSR[UF] ← 1
        ESR[EC] ← 00110
    else if isNaN((rBL)*(rAL)) then
        (rDL) ← signInfinite((rBL)*(rAL))
        FSR[OF] ← 1
        ESR[EC] ← 00110
    else
        (rDL) ← (rBL) * (rAL)
    
```

Registers Altered

- rD_L, unless an FP exception is generated, in which case the register is unchanged
- ESR[EC], if an FP exception is generated
- FSR[IO,UF,OF,DO]

Latency

- 4 cycles with C_AREA_OPTIMIZED=0

- 6 cycles with `C_AREA_OPTIMIZED=1`
- 1 cycle with `C_AREA_OPTIMIZED=2`

Notes

- This instruction is only available when the MicroBlaze parameter `C_USE_FPU` is greater than 0.

Latency

- 28 cycles with `C_AREA_OPTIMIZED=0`
- 30 cycles with `C_AREA_OPTIMIZED=1`
- 24 cycles with `C_AREA_OPTIMIZED=2`

Notes

- This instruction is only available when the MicroBlaze parameter `C_USE_FPU` is greater than 0.

dcmp

Figure 172: dcmp

Double Floating-Point Number Comparison

dcmp.un	rD, rA _L , rB _L	Unordered double floating-point comparison
dcmp.lt	rD, rA _L , rB _L	Less than double floating-point comparison
dcmp.eq	rD, rA _L , rB _L	Equal double floating-point comparison
dcmp.le	rD, rA _L , rB _L	Less-or-Equal double floating-point comparison
dcmp.gt	rD, rA _L , rB _L	Greater than double floating-point comparison
dcmp.ne	rD, rA _L , rB _L	Not Equal double floating-point comparison
dcmp.ge	rD, rA _L , rB _L	Greater-or-Equal double floating-point comparison

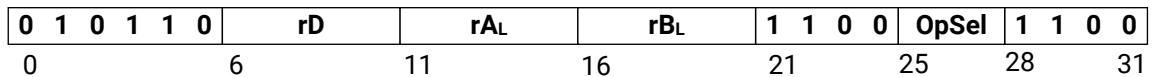

Description

The double precision floating-point value in rB_L is compared with the double precision floating-point value in rA_L and the comparison result is placed into register rD. The OpSel field in the instruction code determines the type of comparison performed.

Pseudocode

```

if isDnz(rAL) or isDnz(rBL) then
    (rD) ← 0
    FSR[DO] ← 1
    ESR[EC] ← 00110
else
    {read out behavior from Table: Table 103}
    
```

Registers Altered

- rD_L, unless an FP exception is generated, in which case the register is unchanged
- ESR[EC], if an FP exception is generated
- FSR[IO,DO]

Latency

- 1 cycle with C_AREA_OPTIMIZED=0 or 2
- 3 cycles with C_AREA_OPTIMIZED=1

Notes

- These instructions are only available when the MicroBlaze parameter C_USE_FPU is greater than 0.

Table 104: Double Floating-Point Comparison Operation

Comparison Type		Operand Relationship				
Description	OpSel	$(rB_L) > (rA_L)$	$(rB_L) < (rA_L)$	$(rB_L) = (rA_L)$	isSigNaN(rA_L) or isSigNaN(rB_L)	isQuietNaN(rA_L) or isQuietNaN(rB_L)
Unordered	000	$(rD) \leftarrow 0$	$(rD) \leftarrow 0$	$(rD) \leftarrow 0$	$(rD) \leftarrow 1$ FSR[IO] $\leftarrow 1$ ESR[EC] $\leftarrow 00110$	$(rD) \leftarrow 1$
Less-than	001	$(rD) \leftarrow 0$	$(rD) \leftarrow 1$	$(rD) \leftarrow 0$	$(rD) \leftarrow 0$ FSR[IO] $\leftarrow 1$ ESR[EC] $\leftarrow 00110$	$(rD) \leftarrow 0$ FSR[IO] $\leftarrow 1$ ESR[EC] $\leftarrow 00110$
Equal	010	$(rD) \leftarrow 0$	$(rD) \leftarrow 0$	$(rD) \leftarrow 1$	$(rD) \leftarrow 0$ FSR[IO] $\leftarrow 1$ ESR[EC] $\leftarrow 00110$	$(rD) \leftarrow 0$
Less-or-equal	011	$(rD) \leftarrow 0$	$(rD) \leftarrow 1$	$(rD) \leftarrow 1$	$(rD) \leftarrow 0$ FSR[IO] $\leftarrow 1$ ESR[EC] $\leftarrow 00110$	$(rD) \leftarrow 0$ FSR[IO] $\leftarrow 1$ ESR[EC] $\leftarrow 00110$
Greater-than	100	$(rD) \leftarrow 1$	$(rD) \leftarrow 0$	$(rD) \leftarrow 0$	$(rD) \leftarrow 0$ FSR[IO] $\leftarrow 1$ ESR[EC] $\leftarrow 00110$	$(rD) \leftarrow 0$ FSR[IO] $\leftarrow 1$ ESR[EC] $\leftarrow 00110$
Not-equal	101	$(rD) \leftarrow 1$	$(rD) \leftarrow 1$	$(rD) \leftarrow 0$	$(rD) \leftarrow 1$ FSR[IO] $\leftarrow 1$ ESR[EC] $\leftarrow 00110$	$(rD) \leftarrow 1$
Greater-or-equal	110	$(rD) \leftarrow 1$	$(rD) \leftarrow 0$	$(rD) \leftarrow 1$	$(rD) \leftarrow 0$ FSR[IO] $\leftarrow 1$ ESR[EC] $\leftarrow 00110$	$(rD) \leftarrow 0$ FSR[IO] $\leftarrow 1$ ESR[EC] $\leftarrow 00110$

dbl

Figure 173: **dbl**

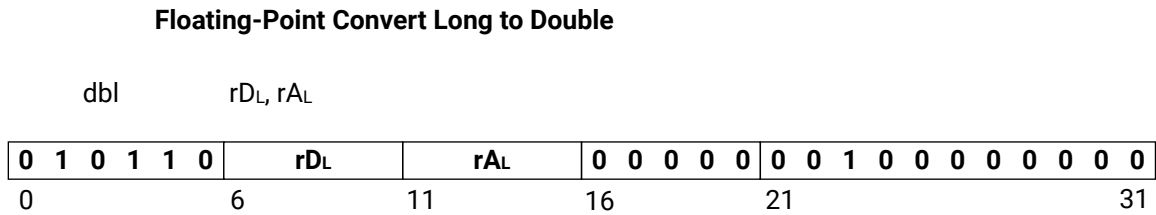

Description

Converts the signed long value in register rA_L to double precision floating-point and puts the result in register rD_L. This is a 64-bit rounding signed conversion that will produce a 64-bit floating-point result.

Pseudocode

```
(rDL) ← double ((rAL))
```

Registers Altered

- rD_L

Latency

- 5 cycles with C_AREA_OPTIMIZED=0
- 7 cycles with C_AREA_OPTIMIZED=1
- 2 cycles with C_AREA_OPTIMIZED=2

Notes

- This instruction is only available when the MicroBlaze parameter C_USE_FPU is set to 2 (Extended).

Notes

- This instruction is only available when the MicroBlaze parameter `C_USE_FPU` is set to 2 (Extended).

dsqrt

Figure 175: dsqrt

Double Floating-Point Arithmetic Square Root

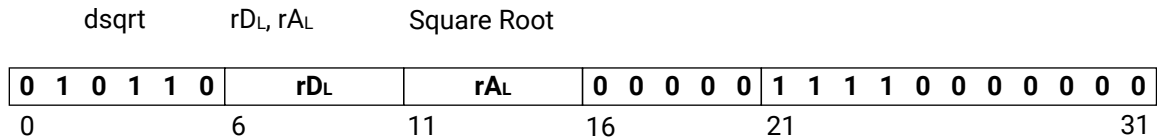

Description

Performs a double precision floating-point square root on the value in rA_L and puts the result in register rD_L.

Pseudocode

```

if isDnz(rAL) then
    (rDL) ← 0xFFF8000000000000
    FSR[DO] ← 1
    ESR[EC] ← 00110
else if isSigNaN(rAL) then
    (rDL) ← 0xFFF8000000000000
    FSR[IO] ← 1
    ESR[EC] ← 00110
else if isQuietNaN(rAL) then
    (rDL) ← 0xFFF8000000000000
else if (rAL) < 0 then
    (rDL) ← 0xFFF8000000000000
    FSR[IO] ← 1
    ESR[EC] ← 00110
else if (rAL) = -0 then
    (rDL) ← -0
else
    (rDL) ← sqrt ((rAL))
    
```

Registers Altered

- rD_L, unless an FP exception is generated, in which case the register is unchanged
- ESR[EC], if an FP exception is generated
- FSR[IO,DO]

Latency

- 27 cycles with C_AREA_OPTIMIZED=0
- 29 cycles with C_AREA_OPTIMIZED=1
- 23 cycles with C_AREA_OPTIMIZED=2

Notes

- This instruction is only available when the MicroBlaze parameter `C_USE_FPU` is set to 2 (Extended).

imml

Figure 176: imml

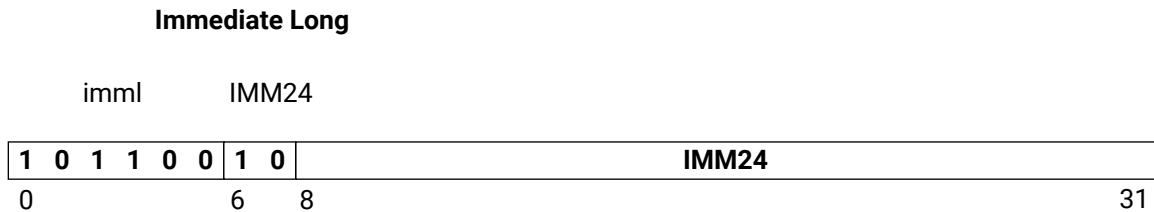

Description

The instruction `imml` loads the IMM24 value into a temporary register. It also locks this value so it can be used by the following instruction and form a 40-bit or 64-bit immediate value, and ensures that the following instruction is treated as a 64-bit Type B instruction.

The instruction `imml` is used with Type B 64-bit instructions.

Up to a 40-bit immediate value can be used for all 64-bit immediate long instructions in MicroBlaze with a single `imml` instruction. The `imml` instruction locks the 24-bit IMM24 value temporarily for the next instruction. A Type B instruction that immediately follows the `imml` instruction will then form a 40-bit immediate value from the 24-bit IMM24 value of the `imml` instruction (upper 24 bits) and its own 16-bit immediate value field (lower 16 bits). If no Type B instruction follows the `imml` instruction, the locked value gets unlocked and becomes useless.

A 64-bit immediate value can be used for all 64-bit immediate long instructions in MicroBlaze with dual `imml` instructions. Each `imml` instruction locks the 24-bit IMM24 value temporarily for the next instruction. A Type B instruction that immediately follows the two `imml` instructions will then form a 64-bit immediate value from the two 24-bit IMM24 values of the `imml` instructions (upper 48 bits) and its own 16-bit immediate value field (lower 16 bits). If no Type B instruction follows the two `imml` instructions, the locked value gets unlocked and becomes useless.

Latency

- 1 cycle

Notes

- The `imml` instruction and the Type B instruction following it are atomic; consequently, no interrupts are allowed between them.
- The assembler automatically detects the need for `imml` instructions.

- When a 40-bit IMM value is specified in a Type B instruction, the assembler converts the IMM value to a 16-bit one to assemble the instruction and inserts an `imml` instruction before it in the executable file. If the immediate value exceeds 40 bits, the assembler converts the IMM value to a 16-bit one to assemble the instruction and inserts two `imml` instructions before it in the executable file.

- ESR[DIZ], if a data storage exception is generated
- ESR[W], ESR[Rx], if an unaligned data access exception is generated

Latency

- 2 cycles with C_AREA_OPTIMIZED=0 or 2
- 3 cycles with C_AREA_OPTIMIZED=1

Notes

- The long reversed instruction is only valid if MicroBlaze is configured to use reorder instructions (C_USE_REORDER_INSTR = 1).

lli

Figure 178: lli

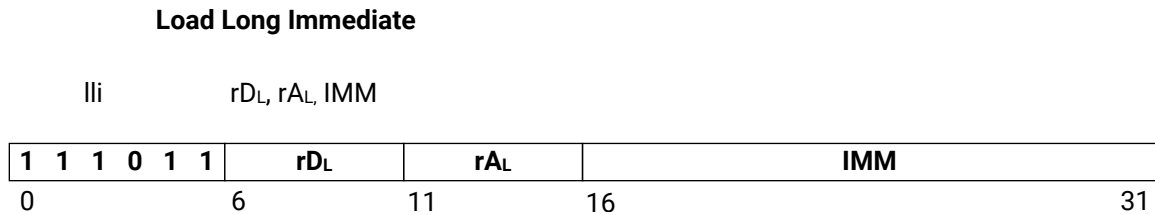

Description

Loads a long (64 bits) from the long aligned memory location that results from adding the contents of register rA_L and the sign-extended IMM value. The data is placed in register rD_L.

A data TLB miss exception occurs if virtual protected mode is enabled, and a valid translation entry corresponding to the address is not found in the TLB.

A data storage exception occurs if access is prevented by a no-access-allowed zone protection. This only applies to accesses with user mode and virtual protected mode enabled.

An unaligned data access exception occurs if the three least significant bits in the address are not zero

Pseudocode

```

Addr ← (rAL) + sext(IMM)
if TLB_Miss(Addr) and MSR[VM] = 1 then
    ESR[EC] ← 10010; ESR[S] ← 0
    MSR[UMS] ← MSR[UM]; MSR[VMS] ← MSR[VM]; MSR[UM] ← 0; MSR[VM] ← 0
else if Access_Protected(Addr) and MSR[UM] = 1 and MSR[VM] = 1 then
    ESR[EC] ← 10000; ESR[S] ← 0; ESR[DIZ] ← 1
    MSR[UMS] ← MSR[UM]; MSR[VMS] ← MSR[VM]; MSR[UM] ← 0; MSR[VM] ← 0
else if Addr[C_ADDR_SIZE-3:C_ADDR_SIZE-1] ≠ 0 then
    ESR[EC] ← 00001; ESR[W] ← 1; ESR[S] ← 0; ESR[Rx] ← rD
else
    (rDL) ← Mem(Addr)
    
```

Registers Altered

- rD_L, unless an exception is generated, in which case the register is unchanged
- MSR[UM], MSR[VM], MSR[UMS], MSR[VMS], if a TLB miss exception or a data storage exception is generated
- ESR[EC], ESR[S], if an exception is generated
- ESR[DIZ], if a data storage exception is generated
- ESR[W], ESR[Rx], if an unaligned data access exception is generated

Latency

- 2 cycles with `C_AREA_OPTIMIZED=0` or 2
- 3 cycles with `C_AREA_OPTIMIZED=1`

Notes

- By default, Type B load immediate instructions will take the 16-bit IMM field value and sign extend it to 64 bits to use as the immediate operand. This behavior can be overridden by preceding the Type B instruction with an `imm` or `imml` instruction. See the instructions [imm](#) and [imml](#) for details on using 64-bit immediate values.

orli

Figure 180: orli

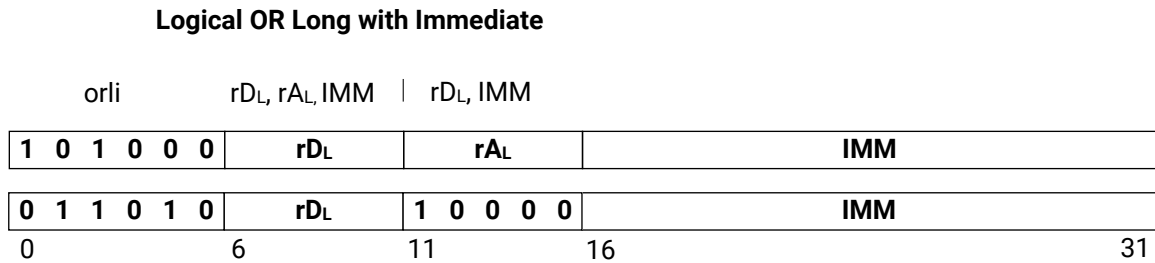

Description

The contents of register rA_L or rD_L are ORed with the IMM field, sign extended with the immediate value from the preceding imml instructions; the result is placed into register rD_L.

Pseudocode

```
(rDL) ← (rAL | rDL) ∨ sext(IMM)
```

Registers Altered

- rD_L

Latency

- 1 cycle

Notes

- Type B logical long instructions with three operands must be preceded by an imml instruction. See the instruction [imml](#) for details on using long immediate values.

pcmplbf

Figure 181: pcmplbf

Pattern Compare Long Byte Find

pcmplbf rD, rA_L, rB_L Bytewise comparison returning position of first match

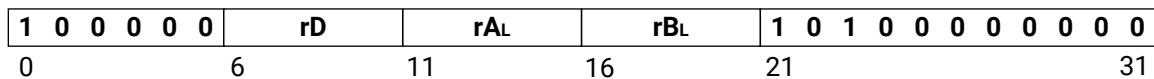

Description

The contents of register rA_L are bitwise compared with the contents in register rB_L.

- rD is loaded with the position of the first matching byte pair, starting with MSB as position 1, and comparing until LSB as position 8
- If none of the byte pairs match, rD is set to 0

Pseudocode

```

if rBL[0:7] = rAL[0:7] then
    (rD) ← 1
else if rBL[8:15] = rAL[8:15] then
    (rD) ← 2
else if rBL[16:23] = rAL[16:23] then
    (rD) ← 3
else if rBL[24:31] = rAL[24:31] then
    (rD) ← 4
else if rBL[32:39] = rAL[32:39] then
    (rD) ← 5
else if rBL[40:47] = rAL[40:47] then
    (rD) ← 6
else if rBL[48:55] = rAL[48:55] then
    (rD) ← 7
else if rBL[56:63] = rAL[56:63] then
    (rD) ← 8
else
    (rD) ← 0
    
```

Registers Altered

- rD

Latency

- 1 cycle

Notes

- This instruction is only available when the parameter C_USE_PCOMP_INSTR is set to 1.

pcmpleq

Figure 182: pcmpleq

Pattern Compare Long Equal

pcmpleq rD, rA_L, rB_L Equality comparison with a positive boolean result

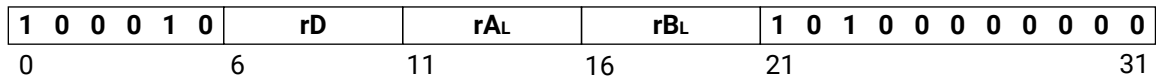

Description

The contents of register rA_L are compared with the contents in register rB_L.

- rD is loaded with 1 if they match, and 0 if not

Pseudocode

```

if (rBL) = (rAL) then
    (rD) ← 1
else
    (rD) ← 0
    
```

Registers Altered

- rD

Latency

- 1 cycle

Notes

- This instruction is only available when the parameter C_USE_PCMP_INSTR is set to 1.

pcmplne

Figure 183: **pcmplne**

Pattern Compare Long Not Equal

pcmplne rD, rA_L, rB_L Equality comparison with a negative boolean result

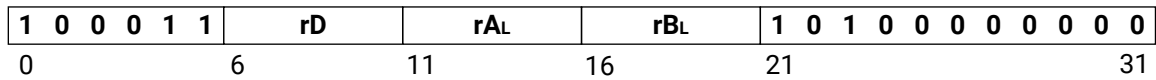

Description

The contents of register rA_L are compared with the contents in register rB_L.

- rD is loaded with 0 if they match, and 1 if not

Pseudocode

```

if (rBL) = (rAL) then
    (rD) ← 0
else
    (rD) ← 1
    
```

Registers Altered

- rD

Latency

- 1 cycle

Notes

- This instruction is only available when the parameter C_USE_PCMP_INSTR is set to 1.

Notes

- In subtractions, Carry = (Borrow). When the Carry is set by a subtraction, it means that there is no Borrow, and when the Carry is cleared, it means that there is a Borrow.

rsubli

Figure 185: rsubli

Arithmetic Reverse Subtract Long Immediate

rsubli	rD _L , rA _L , IMM		rD _L , IMM	Subtract Long Immediate
rsublic	rD _L , rA _L , IMM		rD _L , IMM	Subtract Long Immediate with Carry
rsublik	rD _L , rA _L , IMM		rD _L , IMM	Subtract Long Immediate and Keep Carry
rsublikc	rD _L , rA _L , IMM		rD _L , IMM	Subtract Long Immediate with Carry and Keep Carry

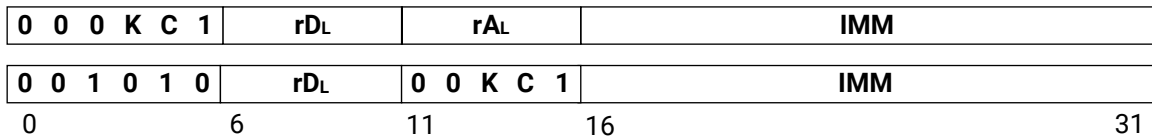

Description

The contents of register rA_L or rD_L are subtracted from the value of IMM, sign extended with the immediate value from the preceding imml instructions, and the result is placed into register rD_L. Bit 3 or 13 of the instruction (labeled as K in the figure) is set to one for the mnemonic rsublik. Bit 4 or 14 of the instruction (labeled as C in the figure) is set to one for the mnemonic rsublic. Both bits are set to one for the mnemonic rsublikc.

When an rsubli instruction has bit 3 or 13 set (rsublik, rsublikc), the carry flag will Keep its previous value regardless of the outcome of the execution of the instruction. If bit 3 or 13 is cleared (rsubli, rsublic), then the carry flag will be affected by the execution of the instruction.

When bit 4 or 14 of the instruction is set to one (rsublic, rsublikc), the content of the carry flag (MSR[C]) affects the execution of the instruction. When bit 4 or 14 is cleared (rsubli, rsublik), the content of the carry flag does not affect the execution of the instruction (providing a normal subtraction).

Pseudocode

```

if C = 0 then
    (rDL) ← sext(IMM) + (rAL | rDL) + 1
else
    (rDL) ← sext(IMM) + (rAL | rDL) + MSR[C]
if K = 0 then
    MSR[C] ← CarryOut64
    
```

Registers Altered

- rD_L
- MSR[C]

Latency

- 1 cycle

Notes

- In subtractions, Carry = (Borrow). When the Carry is set by a subtraction, it means that there is no Borrow, and when the Carry is cleared, it means that there is a Borrow.
- Type B arithmetic long instructions with three operands must be preceded by an `imml` instruction. See the instruction [imml](#) for details on using long immediate values.

sextl16

Figure 186: **sextl16**

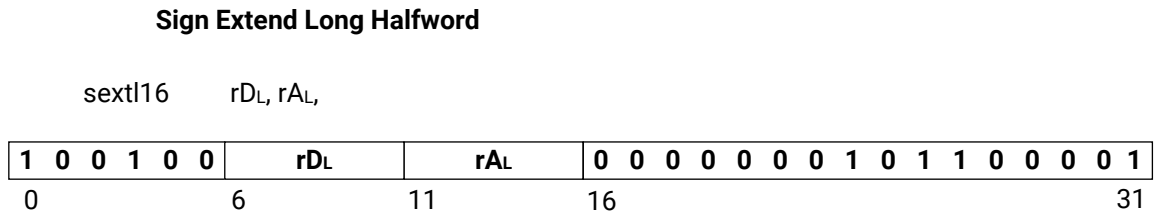

Description

This instruction sign-extends a halfword (16 bits) into a long (64 bits). Bit 48 in rA_L will be copied into bits 0-47 of rD_L. Bits 48-63 in rA_L will be copied into bits 48-63 of rD_L.

Pseudocode

```
rDL[0:47] ← (rAL)[48]
(rDL)[48:63] ← (rAL)[48:63]
```

Registers Altered

- rD_L

Latency

- 1 cycle

sextl32

Figure 187: **sextl32**

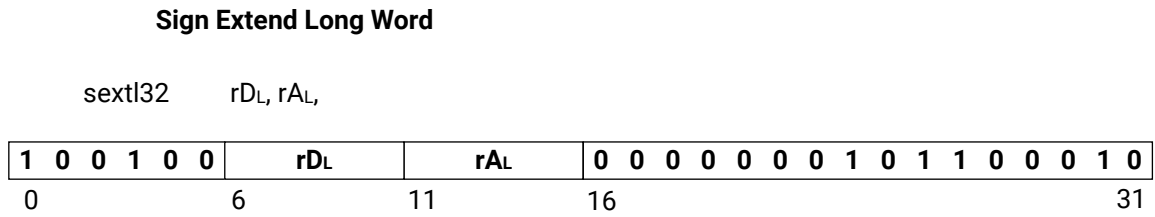

Description

This instruction sign-extends a word (32 bits) into a long (64 bits). Bit 32 in rA_L will be copied into bits 0-31 of rD_L. Bits 32-63 in rA_L will be copied into bits 32-63 of rD_L.

Pseudocode

```
(rDL)[0:31] ← (rAL)[32]
(rDL)[32:63] ← (rAL)[32:63]
```

Registers Altered

- rD_L

Latency

- 1 cycle

sextl8

Figure 188: sextl8

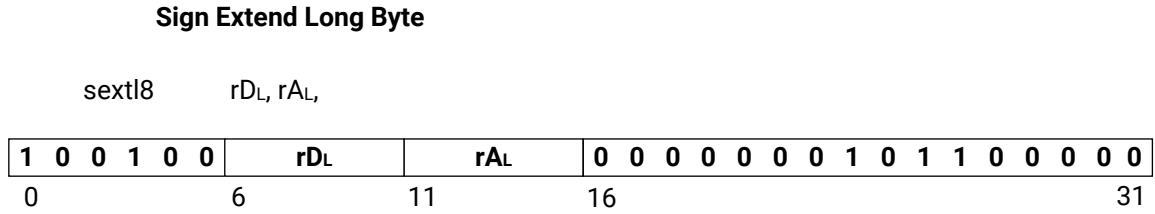

Description

This instruction sign-extends a byte (8 bits) into a long (64 bits). Bit 56 in rA_L will be copied into bits 0-55 of rD_L. Bits 56-63 in rA_L will be copied into bits 56-63 of rD_L.

Pseudocode

```
(rDL)[0:55] ← (rAL)[56]
(rDL)[56:63] ← (rAL)[56:63]
```

Registers Altered

- rD_L

Latency

- 1 cycle

srla

Figure 189: srla

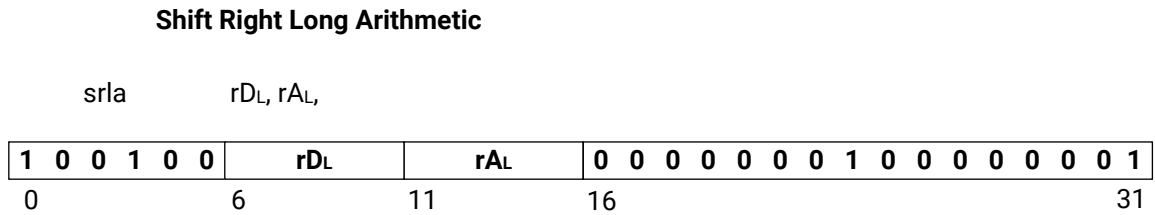

Description

Shifts arithmetically the contents of register rA_L, one bit to the right, and places the result in rD_L. The most significant bit of rA_L (that is, the sign bit) placed in the most significant bit of rD_L. The least significant bit coming out of the shift chain is placed in the Carry flag.

Pseudocode

```
(rDL)[0] ← (rAL)[0]
(rDL)[1:63] ← (rAL)[0:62]
MSR[C] ← (rAL)[63]
```

Registers Altered

- rD_L
- MSR[C]

Latency

- 1 cycle

srlc

Figure 190: srlc

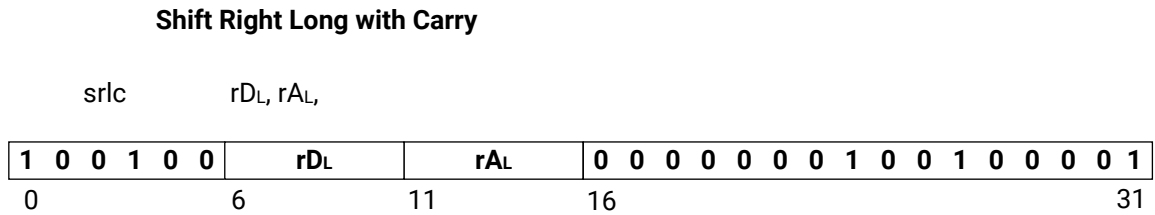

Description

Shifts the contents of register rA_L, one bit to the right, and places the result in rD_L. The Carry flag is shifted in the shift chain and placed in the most significant bit of rD_L. The least significant bit coming out of the shift chain is placed in the Carry flag.

Pseudocode

```
(rDL)[0] ← MSR[C]
(rDL)[1:63] ← (rAL)[0:62]
MSR[C] ← (rAL)[63]
```

Registers Altered

- rD_L
- MSR[C]

Latency

- 1 cycle

srl

Figure 191: srl

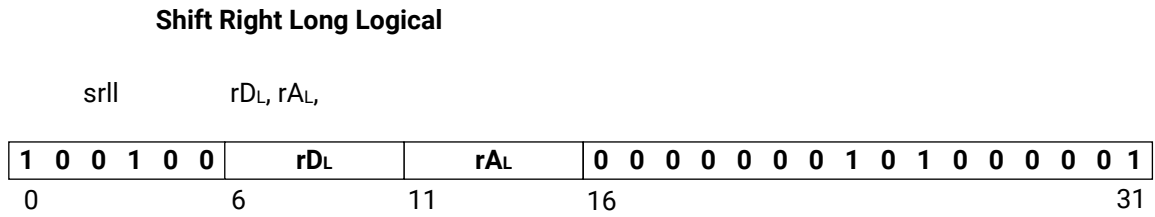

Description

Shifts logically the contents of register rA_L, one bit to the right, and places the result in rD_L. A zero is shifted in the shift chain and placed in the most significant bit of rD_L. The least significant bit coming out of the shift chain is placed in the Carry flag.

Pseudocode

```

rDL[0] ← 0
(rDL)[1:63] ← (rAL)[0:62]
MSR[C] ← (rAL)[63]
    
```

Registers Altered

- rD_L
- MSR[C]

Latency

- 1 cycle

sl

Figure 192: sl



Description

Stores the contents of register rD_L, into the long aligned memory location that results from adding the contents of registers rA_L and rB_L.

If the R bit is set, the bytes in the stored long are reversed, storing data with the opposite endianness of the endianness defined by the E bit (if virtual protected mode is enabled).

A data TLB miss exception occurs if virtual protected mode is enabled, and a valid translation entry corresponding to the address is not found in the TLB.

A data storage exception occurs if virtual protected mode is enabled, and access is prevented by no-access-allowed or read-only zone protection. No-access-allowed can only occur in user mode.

An unaligned data access exception occurs if the three least significant bits in the address are not zero.

Pseudocode

```

Addr ← (rAL) + (rBL)
if TLB_Miss(Addr) and MSR[VM] = 1 then
    ESR[EC] ← 10010; ESR[S] ← 1
    MSR[UMS] ← MSR[UM]; MSR[VMS] ← MSR[VM]; MSR[UM] ← 0; MSR[VM] ← 0
else if Access_Protected(Addr) and MSR[VM] = 1 then
    ESR[EC] ← 10000; ESR[S] ← 1 ; ESR[DIZ] ← No-access-allowed
    MSR[UMS] ← MSR[UM]; MSR[VMS] ← MSR[VM]; MSR[UM] ← 0; MSR[VM] ← 0
else if Addr[C_ADDR_SIZE-3:C_ADDR_SIZE-1] ≠ 0 then
    ESR[EC] ← 00001; ESR[W] ← 1; ESR[S] ← 1; ESR[Rx] ← rD
else
    Mem(Addr) ← (rDL)
    
```

Registers Altered

- MSR[UM], MSR[VM], MSR[UMS], MSR[VMS], if a TLB miss exception or a data storage exception is generated
- ESR[EC], ESR[S], if an exception is generated
- ESR[DIZ], if a data storage exception is generated

- ESR[W], ESR[Rx], if an unaligned data access exception is generated

Latency

- 2 cycles with C_AREA_OPTIMIZED=0 or 2
- 3 cycles with C_AREA_OPTIMIZED=1

Notes

- The long reversed instruction is only valid if MicroBlaze is configured to use reorder instructions (C_USE_REORDER_INSTR = 1).

sli

Figure 193: sli

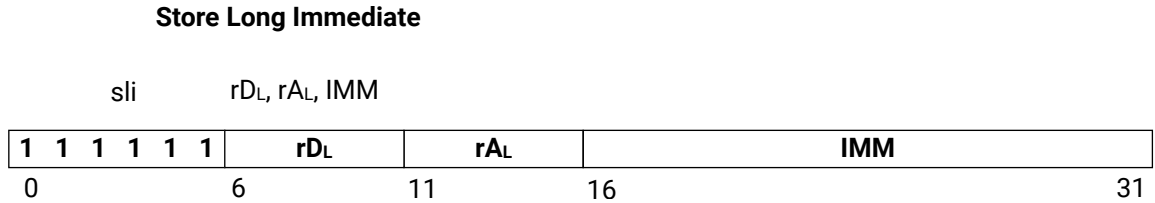

Description

Stores the contents of register rD_L, into the long aligned memory location that results from adding the contents of registers rA_L and the sign-extended IMM value.

A data TLB miss exception occurs if virtual protected mode is enabled, and a valid translation entry corresponding to the address is not found in the TLB.

A data storage exception occurs if virtual protected mode is enabled, and access is prevented by no-access-allowed or read-only zone protection. No-access-allowed can only occur in user mode.

An unaligned data access exception occurs if the three least significant bits in the address are not zero.

Pseudocode

```

Addr ← (rAL) + sext(IMM)
if TLB_Miss(Addr) and MSR[VM] = 1 then
    ESR[EC] ← 10010; ESR[S] ← 1
    MSR[UMS] ← MSR[UM]; MSR[VMS] ← MSR[VM]; MSR[UM] ← 0; MSR[VM] ← 0
else if Access_Protected(Addr) and MSR[VM] = 1 then
    ESR[EC] ← 10000; ESR[S] ← 1; ESR[DIZ] ← No-access-allowed
    MSR[UMS] ← MSR[UM]; MSR[VMS] ← MSR[VM]; MSR[UM] ← 0; MSR[VM] ← 0
else if Addr[C_ADDR_SIZE-3:C_ADDR_SIZE-1] ≠ 0 then
    ESR[EC] ← 00001; ESR[W] ← 1; ESR[S] ← 1; ESR[Rx] ← rD
else
    Mem(Addr) ← (rDL)
    
```

Registers Altered

- MSR[UM], MSR[VM], MSR[UMS], MSR[VMS], if a TLB miss exception or a data storage exception is generated
- ESR[EC], ESR[S], if an exception is generated
- ESR[DIZ], if a data storage exception is generated
- ESR[W], ESR[Rx], if an unaligned data access exception is generated

Latency

- 2 cycles with `C_AREA_OPTIMIZED=0` or 2
- 3 cycles with `C_AREA_OPTIMIZED=1`

Notes

- By default, Type B store immediate instructions will take the 16-bit IMM field value and sign extend it to 64 bits to use as the immediate operand. This behavior can be overridden by preceding the Type B instruction with an `imm` or `imml` instruction.

xorl

Figure 194: xorl

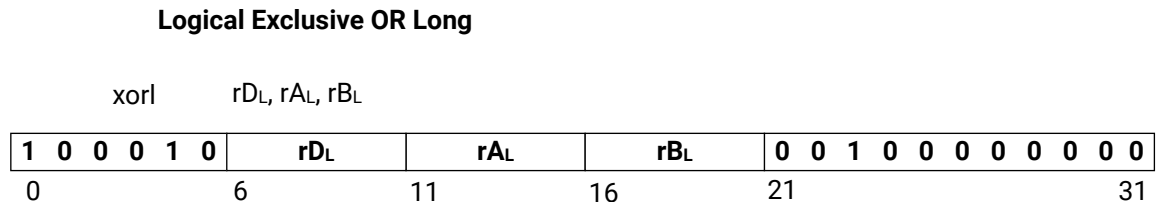

Description

The contents of register rA_L are XORed with the contents of register rB_L; the result is placed into register rD_L.

Pseudocode

$$(rD_L) \leftarrow (rA_L) \oplus (rB_L)$$

Registers Altered

- rD_L

Latency

- 1 cycle

xorli

Figure 195: xorli

Logical Exclusive OR Long with Immediate

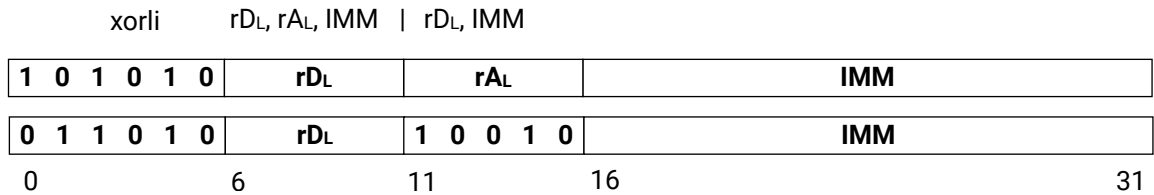

Description

The contents of register rA_L or rD_L are XOR'ed with the IMM field, sign extended with the immediate value from the preceding imml instructions; the result is placed into register rD_L.

Pseudocode

```
(rDL) ← (rAL | rDL) ⊕ sext(IMM24 & IMM)
```

Registers Altered

- rD_L

Latency

- 1 cycle

Notes

- Type B logical long instructions with three operands must be preceded by an imml instruction. See the instruction [imml](#) for details on using long immediate values.

Performance and Resource Utilization

Performance

Performance characterization of this core has been done using the margin system methodology. The details of the margin system characterization methodology is described in [IP Characterization and F_{MAX} Margin System Methodology](#) below.

For additional details about performance and resource utilization, visit [Performance and Resource Utilization](#).

Maximum Frequencies

The maximum frequencies for the MicroBlaze™ core are provided in the following table. The fastest speed grade of each family is used to generate the results in this table.

Table 105: Maximum Frequencies

Family	F _{max} (MHz)
AMD Virtex™ 7	382
AMD Kintex™ 7	398
AMD Artix™ 7	267
AMD Zynq™ 7000	265
AMD Spartan™ 7	234
Virtex UltraScale	460
Kintex UltraScale	463
AMD Virtex™ UltraScale+™	682
Kintex UltraScale+	650
Zynq UltraScale+	661
Spartan UltraScale+	432
AMD Versal™	456

Resource Utilization

The MicroBlaze core resource utilization for various parameter configurations are measured for the following devices:

- [Virtex 7 Devices](#)
- [Kintex 7 Devices](#)
- [Artix 7 Devices](#)
- [Zynq 7000 Devices](#)
- [Spartan 7 Devices](#)
- [Virtex UltraScale Devices](#)
- [Kintex UltraScale Devices](#)
- [Virtex UltraScale+ Devices](#)
- [Kintex UltraScale+ Devices](#)
- [Zynq UltraScale+ Devices](#)
- [Spartan UltraScale+ Devices](#)
- [Versal Devices](#)

The parameter values for each of the measured configurations are shown in [Table 118: Parameter Configurations](#). The configurations directly correspond to the predefined presets and templates in the MicroBlaze Configuration Wizard, defined for the 32-bit processor implementation.

The 32-bit processor implementation data uses the parameters `C_DATA_SIZE = 32` and `C_ADDR_SIZE = 32`, whereas the 64-bit processor implementation data uses the parameters `C_DATA_SIZE = 64` and `C_ADDR_SIZE = 48`.

Virtex 7 Devices

Table 106: Device Utilization - Virtex 7 FPGAs (XC7VX485T ffg1761-3)

Configuration	Device Resources							
	32-bit				64-bit			
	LUTs	FFs	BRAMs (36K)	F _{max} (MHz)	LUTs	FFs	BRAMs (36K)	F _{max} (MHz)
Microcontroller Preset	1173	811	0	308	2139	1262	0	286
Real-time Preset	2484	2121	6	245	3793	3150	6	241
Application Preset	4340	3807	19	212	6492	4919	19	165
Minimum Area	629	230	0	382	1133	400	0	329
Maximum Performance	4096	3210	19	218	6813	4778	20	172
Maximum Frequency	915	553	0	382	1815	858	0	329
Linux with MMU	3512	3126	11	213	5084	4496	16	198
Low-end Linux with MMU	2986	2511	7	233	4519	3726	10	207
Typical	2007	1680	6	253	3389	2498	8	251
Frequency Optimized	6011	5791	14	252	9398	8735	15	168

Kintex 7 Devices

Table 107: Device Utilization - Kintex 7 FPGAs (XC7K325T ffg900-3)

Configuration	Device Resources							
	32-bit				64-bit			
	LUTs	FFs	BRAMs (36K)	F _{max} (MHz)	LUTs	FFs	BRAMs (36K)	F _{max} (MHz)
Microcontroller Preset	1176	811	0	318	2129	1226	0	287
Real-time Preset	2477	2121	6	246	3792	3151	6	220
Application Preset	4368	3779	19	214	6479	4899	19	174
Minimum Area	637	234	0	398	1146	398	0	330
Maximum Performance	4129	3207	19	222	6816	4778	20	171
Maximum Frequency	908	553	0	398	1817	862	0	330
Linux with MMU	3507	3149	11	206	5088	4493	16	205
Low-end Linux with MMU	2986	2537	7	213	4521	3708	10	202
Typical	2017	1679	6	257	3404	2496	8	252
Frequency Optimized	6004	5874	14	263	9425	8765	15	172

Artix 7 Devices

Table 108: Device Utilization - Artix 7 FPGAs (XC7A200T fbg676-3)

Configuration	Device Resources							
	32-bit				64-bit			
	LUTs	FFs	BRAMs (36K)	F _{max} (MHz)	LUTs	FFs	BRAMs (36K)	F _{max} (MHz)
Microcontroller Preset	1174	811	0	218	2145	1226	0	187
Real-time Preset	2467	2121	6	177	3797	3153	6	178
Application Preset	4326	3747	19	149	6461	4891	19	136
Minimum Area	625	227	0	267	1141	397	0	221
Maximum Performance	4106	3208	19	153	6802	4799	20	142
Maximum Frequency	911	553	0	267	1815	858	0	221
Linux with MMU	3515	3122	11	150	5081	4492	16	139
Low-end Linux with MMU	2987	2506	7	151	4490	3711	10	136
Typical	2014	1682	6	187	3398	2500	8	190
Frequency Optimized	5956	5787	14	166	9366	8725	15	137

Zynq 7000 Devices

Table 109: Device Utilization - Zynq 7000 FPGAs (XC7Z020 clg484-3)

Configuration	Device Resources							
	32-bit				64-bit			
	LUTs	FFs	BRAMs (36K)	F _{max} (MHz)	LUTs	FFs	BRAMs (36K)	F _{max} (MHz)
Microcontroller Preset	1174	811	0	221	2148	1226	0	191
Real-time Preset	2465	2120	6	176	3785	3156	6	178
Application Preset	4345	3744	19	148	6496	4979	19	141
Minimum Area	626	226	0	265	1138	400	0	222
Maximum Performance	4105	3197	19	152	6791	4760	20	138
Maximum Frequency	908	553	0	265	1813	858	0	222
Linux with MMU	3507	3125	11	147	5086	4489	16	135
Low-end Linux with MMU	2988	2506	7	159	4489	3711	10	138
Typical	2021	1680	6	191	3416	2501	8	192
Frequency Optimized	5953	5785	14	176	9381	8724	15	134

Spartan 7 Devices

Table 110: Device Utilization - Spartan 7 FPGAs (XC7S25 csga225-2)

Configuration	Device Resources							
	32-bit				64-bit			
	LUTs	FFs	BRAMs (36K)	F _{max} (MHz)	LUTs	FFs	BRAMs (36K)	F _{max} (MHz)
Microcontroller Preset	1175	811	0	188	2134	1226	0	161
Real-time Preset	2461	2125	6	161	3810	3151	6	148
Application Preset	4342	3812	19	130	6465	4872	19	120
Minimum Area	625	225	0	234	1145	406	0	199
Maximum Performance	4085	3197	19	134	6779	4757	20	118
Maximum Frequency	909	553	0	234	1816	858	0	199
Linux with MMU	3505	3128	11	133	5077	4490	16	118
Low-end Linux with MMU	2980	2509	7	144	4466	3709	10	122
Typical	2020	1680	6	168	3406	2492	8	160
Frequency Optimized	5955	5783	14	154	9363	8724	15	119

Virtex UltraScale Devices

Table 111: Device Utilization - Virtex UltraScale FPGAs (XCVU095 ffd1924-3)

Configuration	Device Resources							
	32-bit				64-bit			
	LUTs	FFs	BRAMs (36K)	F _{max} (MHz)	LUTs	FFs	BRAMs (36K)	F _{max} (MHz)
Microcontroller Preset	1105	821	0	413	2090	1226	0	345
Real-time Preset	2520	2121	6	295	3822	3158	6	293
Application Preset	4355	3801	19	262	6617	4826	19	238
Minimum Area	567	231	0	460	991	415	0	374
Maximum Performance	4102	3208	19	286	6936	4776	20	244
Maximum Frequency	913	553	0	460	1817	860	0	374
Linux with MMU	3523	3221	11	258	5149	4511	16	239
Low-end Linux with MMU	3002	2518	7	271	4559	3728	10	234
Typical	2035	1680	6	316	3482	2497	8	307
Frequency Optimized	6150	5806	14	301	9579	8814	15	240

Kintex UltraScale Devices

Table 112: Device Utilization - Kintex UltraScale FPGAs (XCKU040 ffva1156-3)

Configuration	Device Resources							
	32-bit				64-bit			
	LUTs	FFs	BRAMs (36K)	F _{max} (MHz)	LUTs	FFs	BRAMs (36K)	F _{max} (MHz)
Microcontroller Preset	1106	811	0	417	2046	1261	0	352
Real-time Preset	2507	2119	6	300	3820	3155	6	302
Application Preset	4336	3760	19	255	6621	4961	19	233
Minimum Area	578	240	0	463	988	401	0	391
Maximum Performance	4117	3209	19	285	6943	4784	20	249
Maximum Frequency	913	556	0	463	1832	869	0	391
Linux with MMU	3502	3129	11	247	5142	4492	16	239
Low-end Linux with MMU	2997	2507	7	267	4560	3745	10	233
Typical	2033	1683	6	319	3471	2505	8	313
Frequency Optimized	6172	5837	14	307	9574	8777	15	243

Virtex UltraScale+ Devices

Table 113: Device Utilization - Virtex UltraScale+ FPGAs (XCVU3P ffvc1517-3)

Configuration	Device Resources							
	32-bit				64-bit			
	LUTs	FFs	BRAMs (36K)	F _{max} (MHz)	LUTs	FFs	BRAMs (36K)	F _{max} (MHz)
Microcontroller Preset	1107	823	0	573	2063	1226	0	462
Real-time Preset	2543	2122	6	399	3911	3156	6	389
Application Preset	4403	3745	19	360	6679	4872	19	333
Minimum Area	563	225	0	682	991	397	0	602
Maximum Performance	4207	3208	19	371	7044	4772	20	330
Maximum Frequency	910	553	0	682	1816	858	0	602
Linux with MMU	3553	3129	11	350	5213	4486	16	333
Low-end Linux with MMU	3020	2508	7	374	4595	3705	10	333
Typical	2064	1679	6	433	3492	2496	8	427
Frequency Optimized	6227	5789	14	416	9649	8773	15	344

Kintex UltraScale+ Devices

Table 114: Device Utilization - Kintex UltraScale+ FPGAs (XCKU15P ffva1156-3)

Configuration	Device Resources							
	32-bit				64-bit			
	LUTs	FFs	BRAMs (36K)	F _{max} (MHz)	LUTs	FFs	BRAMs (36K)	F _{max} (MHz)
Microcontroller Preset	1105	811	0	573	2049	1226	0	522
Real-time Preset	2449	2122	6	416	3914	3151	6	407
Application Preset	4404	3744	19	349	6693	4873	19	341
Minimum Area	566	225	0	650	996	397	0	602
Maximum Performance	4209	3237	19	371	7045	4778	20	340
Maximum Frequency	915	553	0	650	1814	858	0	602
Linux with MMU	3554	3190	11	351	5216	4491	16	323
Low-end Linux with MMU	3023	2507	7	365	4598	3712	10	344
Typical	2067	1681	6	441	3489	2493	8	421
Frequency Optimized	6223	5787	14	433	9652	8766	15	340

Zynq UltraScale+ Devices

Table 115: Device Utilization - Zynq UltraScale+ FPGAs (XCZU9EG ffvb1156-3)

Configuration	Device Resources							
	32-bit				64-bit			
	LUTs	FFs	BRAMs (36K)	F _{max} (MHz)	LUTs	FFs	BRAMs (36K)	F _{max} (MHz)
Microcontroller Preset	1112	822	0	561	2046	1226	0	476
Real-time Preset	2540	2120	6	409	3912	3150	6	388
Application Preset	4415	3743	19	346	6684	4888	19	336
Minimum Area	566	229	0	661	995	407	0	573
Maximum Performance	4212	3207	19	372	7027	4779	20	336
Maximum Frequency	908	553	0	661	1818	858	0	573
Linux with MMU	3552	3121	11	338	5227	4553	16	335
Low-end Linux with MMU	3018	2501	7	369	4597	3703	10	319
Typical	2068	1681	6	430	3490	2493	8	428
Frequency Optimized	6248	5819	14	413	9647	8781	15	348

Spartan UltraScale+ Devices

Table 116: Device Utilization - Spartan UltraScale+ FPGAs (xcsu35p-sbvb625-2-e)

Configuration	Device Resources							
	32-bit				64-bit			
	LUTs	FFs	BRAMs (36K)	F _{max} (MHz)	LUTs	FFs	BRAMs (36K)	F _{max} (MHz)
Microcontroller Preset	1741	498	0	350	2899	774	0	323
Real-time Preset	2069	1875	6	303	3644	3388	6	283
Application Preset	4019	3502	19	232	6196	4514	19	238
Minimum Area	576	223	0	432	1161	415	0	357
Maximum Performance	3771	2781	19	255	6573	4287	20	234
Maximum Frequency	830	481	0	411	1573	789	0	351
Linux with MMU	3213	2878	11	265	4932	4280	16	224
Low-end Linux with MMU	2706	2311	7	262	4209	3454	10	211
Typical	1804	1357	6	315	3004	2110	8	291
Frequency Optimized	5482	5459	14	293	8928	8251	15	244

Versal Devices

Table 117: Device Utilization - Versal FPGAs (XCVC1920 vsva2197-3HP)

Configuration	Device Resources							
	32-bit				64-bit			
	LUTs	FFs	BRAMs (36K)	F _{max} (MHz)	LUTs	FFs	BRAMs (36K)	F _{max} (MHz)
Microcontroller Preset	1841	1257	0	399	2480	1344	0	365
Real-time Preset	5561	5670	4	340	6951	6709	4	289
Application Preset	7543	7326	18	265	9885	8388	18	264
Minimum Area	650	263	0	456	1325	458	0	379
Maximum Performance	6708	6469	17	227	9711	8066	17	254
Maximum Frequency	971	519	0	456	1818	826	0	383
Linux with MMU	6610	6619	10	279	8512	8091	14	253
Low-end Linux with MMU	6008	6021	6	280	7575	7239	8	254
Typical	4071	4136	4	337	5450	5009	6	266
Frequency Optimized	8001	8387	12	286	11602	11173	12	267

Parameter Configurations

Table 118: Parameter Configurations

Parameter	Configuration Parameter Values									
	Microcontroller Preset	Real-time Preset	Application Preset	Minimum Area	Maximum Performance	Maximum Frequency	Linux with MMU	Low-end Linux with MMU	Typical	Frequency Optimized
C_ALLOW_DCACHE_WR	1	1	1	1	1	1	1	1	1	1
C_ALLOW_ICACHE_WR	1	1	1	1	1	1	1	1	1	1
C_AREA_OPTIMIZED	1	0	0	1	0	0	0	0	0	2
C_CACHE_BYTE_SIZE	4096	8192	32768	4096	32768	4096	16384	8192	8192	16384
C_DCACHE_BYTE_SIZE	4096	8192	32768	4096	32768	4096	16384	8192	8192	16384
C_DCACHE_LINE_LEN	4	4	4	4	8	4	4	4	4	4
C_DCACHE_USE_WRITEBACK	0	1	1	0	1	0	0	0	0	1
C_DEBUG_ENABLED	1	1	1	0	1	0	1	1	1	1
C_DIV_ZERO_EXCEPTION	0	1	1	0	0	0	1	0	0	1
C_M_AXI_D_BUS_EXCEPTION	0	1	1	0	0	0	1	1	1	1
C_FPU_EXCEPTION	0	0	1	0	0	0	0	0	0	1
C_FSL_EXCEPTION	0	0	0	0	0	0	0	0	0	0
C_FSL_LINKS	0	0	0	0	0	1	0	0	0	0
C_ICACHE_LINE_LEN	4	4	8	4	8	4	8	4	8	8
C_ILL_OPCODE_EXCEPTION	0	1	1	0	0	0	1	1	0	1
C_M_AXI_I_BUS_EXCEPTION	0	1	1	0	0	0	1	1	0	1
C_MMU_DTLB_SIZE	2	2	4	2	4	2	4	4	4	4
C_MMU_ITLB_SIZE	1	1	2	1	2	1	2	2	2	2
C_MMU_TLB_ACCESS	3	3	3	3	3	3	3	3	3	3
C_MMU_ZONES	2	2	2	2	2	2	2	2	2	2
C_NUMBER_OF_PC_BRK	1	2	2	0	1	1	1	1	2	1
C_NUMBER_OF_RD_ADDR_BRK	0	0	1	0	0	0	0	0	0	0
C_NUMBER_OF_WR_ADDR_BRK	0	0	1	0	0	0	0	0	0	0
C_OPCODE_0x0_ILLEGAL	0	1	1	0	0	0	1	1	0	1
C_PVR	0	0	2	0	0	0	2	0	0	2
C_UNALIGNED_EXCEPTIONS	0	1	1	0	0	0	1	1	0	1
C_USE_BARREL	1	1	1	0	1	0	1	1	1	1

Table 118: Parameter Configurations (cont'd)

Parameter	Configuration Parameter Values									
	Microcontroller Preset	Real-time Preset	Application Preset	Minimum Area	Maximum Performance	Maximum Frequency	Linux with MMU	Low-end Linux with MMU	Typical	Frequency Optimized
C_USE_DCACHE	0	1	1	0	1	0	1	1	1	1
C_USE_DIV	0	1	1	0	1	0	1	0	0	1
C_USE_EXTENDED_FSL_INSTR	0	0	0	0	0	0	0	0	0	0
C_USE_FPU	0	0	1	0	2	0	0	0	0	2
C_USE_HW_MUL	1	1	2	0	2	0	2	1	1	2
C_USE_ICACHE	0	1	1	0	1	0	1	1	1	1
C_USE_MMU	0	0	3	0	0	0	3	3	0	3
C_USE_MSR_INSTR	1	1	1	0	1	0	1	1	1	1
C_USE_PCMP_INSTR	1	1	1	0	1	0	1	1	1	1
C_USE_REORDER_INSTR	0	1	1	0	1	1	1	1	1	1
C_USE_BRANCH_TARGET_CACHE	0	0	0	0	1	0	0	0	0	1
C_BRANCH_TARGET_CACHE_SIZE	0	0	0	0	0	0	0	0	0	0
C_ICACHE_STREAMS	0	0	1	0	1	0	1	0	0	0
C_ICACHE_VICTIMS	0	0	8	0	8	0	8	0	0	0
C_DCACHE_VICTIMS	0	0	0	0	8	0	8	0	0	0
C_ICACHE_FORCE_TAG_LUTRAM	0	0	0	0	0	0	0	0	0	0
C_DCACHE_FORCE_TAG_LUTRAM	0	0	0	0	0	0	0	0	0	0
C_ICACHE_ALWAYS_USED	1	1	1	1	1	1	1	1	0	1
C_DCACHE_ALWAYS_USED	1	1	1	1	1	1	1	1	0	1
C_D_AXI	1	1	1	0	1	0	1	1	0	1
C_USE_INTERRUPT	1	1	1	0	0	0	1	1	0	1
C_USE_STACK_PROTECTION	0	1	0	0	0	0	0	0	0	0

IP Characterization and F_{MAX} Margin System Methodology

Introduction

This section describes the methods to determine the maximum frequency (F_{MAX}) of IP operation within a system design. The method enables realistic performance reporting for any FPGA architecture. The maximum frequency of a design is the maximum frequency at which the overall system can be implemented without encountering timing issues.

The F_{MAX} Margin System Methodology

It is important to determine the IP performance in the context of a user system. In the case of the MicroBlaze characterization, the system includes the following items:

- The IP under test (MicroBlaze Processor)
- Local Memory (LMB)
- One level of Interconnect (AXI4, AXI4-Lite, AXI4-Stream)
- Memory controller (EMC)
- On-chip BRAM controller
- Peripherals (UART, Timer, Interrupt Controller, MDM)

Determining the F_{MAX} of an Embedded IP with these components provides a more realistic performance target.

The system above has three types of AXI Interconnect. AXI4-Lite used for peripheral command and control, AXI4 used for memory accesses, and AXI4-Stream used for MicroBlaze streams.

For F_{MAX} Margin System Analysis, the clock frequency of the system is incremented up to the maximum frequency where the system breaks with timing violations (worst case negative slack). The reported frequency is the failing frequency subtracted with this worst case negative slack.

Tool Options and Other Factors

AMD tools offer a number of options and settings that provide a trade-off between design performance, resource usage, implementation runtime, and memory footprint. The settings that produce the best results for one design might not necessarily work for another design.

For the purpose of the F_{MAX} Margin System Analysis, the IP design is characterized with default settings without specific constraints (other than the clocking constraint). This analysis is done with all different FPGA architectures and the maximum speed grade.

Additional Resources and Legal Notices

Finding Additional Documentation

Technical Information Portal

The AMD Technical Information Portal is an online tool that provides robust search and navigation for documentation using your web browser. To access the Technical Information Portal, go to <https://docs.amd.com>.

Documentation Navigator

Documentation Navigator (DocNav) is an installed tool that provides access to AMD Adaptive Computing documents, videos, and support resources, which you can filter and search to find information. To open DocNav:

- From the AMD Vivado™ IDE, select **Help** → **Documentation and Tutorials**.
- On Windows, click the **Start** button and select **Xilinx Design Tools** → **DocNav**.
- At the Linux command prompt, enter `docnav`.

Note: For more information on DocNav, refer to the *Documentation Navigator User Guide* ([UG968](#)).

Design Hubs

AMD Design Hubs provide links to documentation organized by design tasks and other topics, which you can use to learn key concepts and address frequently asked questions. To access the Design Hubs:

- In DocNav, click the **Design Hubs View** tab.
- Go to the [Design Hubs](#) web page.

Support Resources

For support resources such as Answers, Documentation, Downloads, and Forums, see [Support](#).

References

These documents provide supplemental material useful with this guide:

1. *PowerPC Processor, Reference Guide* ([UG011](#))
2. *Soft Error Mitigation Controller LogiCORE IP Product Guide* ([PG036](#))
3. *LMB BRAM Interface Controller LogiCORE IP Product Guide* ([PG112](#))
4. *MicroBlaze Debug Module (MDM) LogiCORE IP Product Guide* ([PG115](#))
5. *MicroBlaze Microcontroller System LogiCORE IP Product Guide* ([PG116](#))
6. *System Cache LogiCORE IP Product Guide* ([PG118](#))
7. *Triple Modular Redundancy (TMR) LogiCORE IP Product Guide* ([PG268](#))
8. *Device Reliability Report* ([UG116](#))
9. *Hierarchical Design Methodology Guide* ([UG748](#))
10. *Vitis Unified Software Platform Documentation Landing Page* ([UG1416](#))
11. *Vivado Design Suite User Guide: Designing with IP* ([UG896](#))
12. *MicroBlaze Processor Embedded Design User Guide* ([UG1579](#))
13. *Vivado Design Suite User Guide: Designing IP Subsystems Using IP Integrator* ([UG994](#))
14. *Vitis Unified Software Platform Documentation: Embedded Software Development* ([UG1400](#))
15. *AMBA 4 AXI4-Stream Protocol Specification, Version 1.0* ([Arm IHI 0051A](#))
16. *AMBA AXI and ACE Protocol Specification* ([Arm IHI 0022E](#))
17. *UltraScale Architecture Soft Error Mitigation Controller LogiCORE IP Product Guide* ([PG187](#))

The following lists additional resources you can access directly using the provided URLs.

1. The entire set of GNU manuals: <https://www.gnu.org/manual>
2. IEEE 754-1985 standard https://en.wikipedia.org/wiki/IEEE_754-1985
3. Wiki: [MicroBlaze](#), [MicroBlaze Tagged Pages](#)
4. ELF: [Tool Interface Standard \(TIS\) Executable and Linking Format \(ELF\) Specification](#)

Training Resources

AMD provides a variety of QuickTake videos and training courses to help you learn more about the concepts presented in this document. Use these links to explore related training resources:

- [Designing FPGAs Using the Vivado Design Suite 1 Training Course](#)
- [Embedded Systems Design Training Course](#)
- [Embedded Systems Software Design Training Course](#)
- [Vivado Design Suite QuickTake Video Tutorials](#)

Revision History

The following table shows the revision history for this document.

Section	Revision Summary
05/29/2025 Version 2025.1	
General Updates	Updated for Vivado 2025.1 release <ul style="list-style-type: none"> • Corrected GET, GETD, PUT, and PUTD instruction descriptions • Added Spartan UltraScale+ Resource Utilization • Updated Vitis references
11/27/2024 Version 2024.2	
General Updates	Updated for Vivado 2024.2 release
05/30/2024 Version 2024.1	
General Updates	Updated for Vivado 2024.1 release <ul style="list-style-type: none"> • Corrected expanded form of MDM • Clarified that a long multiplication instruction is not defined by the 64-bit ISA • Explained the 8-stage pipeline branch penalty
06/05/2023 Version 2023.1	
General Updates	Updated for Vivado 2023.1 release <ul style="list-style-type: none"> • Editorial updates. • Corrected eight stage pipeline stalls. • Updated branch latency.
05/25/2022 Version 2022.1	
General Updates	Updated for Vivado 2022.1 release <ul style="list-style-type: none"> • Support 64-bit LMB and M_AXI_DP data width. • Added temporal lockstep description. • Replaced reference to UG898 with UG1579.
10/27/2021 Version 2021.2	
General Updates	Updated for Vivado 2021.2 release <ul style="list-style-type: none"> • Added AMD Artix™ AMD UltraScale+™ device

Section	Revision Summary
06/16/2021 Version 2021.1	
General Updates	Updated for Vivado 2021.1 release <ul style="list-style-type: none"> • Corrected MSRCLR and MSRSET in MicroBlaze Instruction Set Summary. • Corrected TNAPUTD and TNCAPUTD in MicroBlaze Instruction Set Summary. • Provided additional information on AXI and ACE interface parameters. • Added missing description of Dbg_Disable signal.
11/18/2020 Version 2020.2	
General Updates	Updated for Vivado 2020.2 release <ul style="list-style-type: none"> • Corrected parity bits in a data cache line. • Added Versal to supported families. • Clarified atomic stream instruction behavior. • Provided performance and resource utilization for Versal.
06/03/2020 Version 2020.1	
General Updates	Updated for Vivado 2020.1 release <ul style="list-style-type: none"> • Added ELF format description. • Describe Memory Protection feature in more detail. • Clarified Peripheral Data AXI write behavior. • Define FINT and DLONG instruction rounding behavior.
10/30/2019 Version 2019.2	
General Updates	Updated for Vivado 2019.2 release: <ul style="list-style-type: none"> • Updated description of 64-bit immediate instructions with added opcodes. • Clarified reset behavior. • Replaced SDK with Vitis. • Added Block-RAM count to resource utilization tables.
24/04/2019 Version 2019.1	
General Updates	Updated for Vivado 2019.1 release: <ul style="list-style-type: none"> • Added information about cache reset behavior. • Included calling convention for variable argument functions. • Corrected WDC pseudo code. • Provided link to MicroBlaze pages on the Xilinx Wiki.
11/14/2018 Version 2018.3	
General Updates	Updated for Vivado 2018.3 release: <ul style="list-style-type: none"> • Added description of MicroBlaze 64-bit implementation, new in version 11.0.

Section	Revision Summary
04/04/2018 Version 2018.1	
General Updates	Updated for Vivado 2018.1 release: <ul style="list-style-type: none"> • Included information about instruction pipeline hazards and forwarding. • Clarified that software break does not set the BIP bit in MSR. • Explained memory scrubbing behavior. • Added more detailed description of sleep and pause usage. • Clarified use of parallel debug clock and reset.
10/04/2017 Version 2017.3	
General Updates	Updated for Vivado 2017.3 release: <ul style="list-style-type: none"> • Added automotive UltraScale+, Zynq, and Spartan 7 devices. • Updated description of debug trace, to add event trace, new in version 10.0. • Added 4PB extended address size. • Clarified description of cache trace signals.
04/05/2017 Version 2017.1	
General Updates	Updated for Vivado 2017.1 release: <ul style="list-style-type: none"> • Added description of MMU Physical Address Extension (PAE), new in version 10.0. • Extended privileged instruction list, and updated instruction descriptions. • Updated information on debug program trace. • Added reference to the Triple Modular Redundancy (TMR) subsystem. • Corrected description of BSIFI instruction. • Updated MFSE instruction description with PAE information. • Added MTSE instruction used with PAE, new in version 10.0. • Updated WDC instruction for external cache invalidate and flush.
10/05/2016 Version 2016.3	
General Updates	Updated for Vivado 2016.3 release: <ul style="list-style-type: none"> • Added description of frequency optimized 8-stage pipeline, new in version 10.0. • Describe bit field instructions, new in version 10.0. • Include information on parallel debug interface, new in version 10.0. • Added version 10.0 to MicroBlaze release version code in PVR. • Included Spartan 7 target architecture in PVR. • Updated description of MSR reset value. • Updated Xilinx

Section	Revision Summary
04/06/2016 Version 2016.1	
General Updates	Updated for Vivado 2016.1 release: <ul style="list-style-type: none"> • Included description of address extension, new in version 9.6. • Included description of pipeline pause functionality, new in version 9.6 • Included description of non-secure AXI access support, new in version 9.6. • Included description of hibernate and suspend instructions, new in version 9.6. • Added version 9.6 to MicroBlaze release version code in PVR. • Corrected references to tables in Performance Counter Data Read Register • Replaced references to the deprecated Xilinx Microprocessor Debugger (XMD) with Xilinx System Debugger (XSDB). • Removed C code function attributes <code>svc_handler</code> and <code>svc_table_handler</code>.
04/15/2015 Version 2015.1	
General Updates	Updated for Vivado 2015.1 release: <ul style="list-style-type: none"> • Included description of 16 word cache line length, new in version 9.5. • Added version 9.5 to MicroBlaze release version code in PVR. • Corrected description of supported endianness and parameter <code>C_ENDIANNES</code>. • Corrected description of outstanding reads for instruction and data cache. • Updated FPGA configuration memory protection document reference <i>MicroBlaze Microcontroller System LogiCORE IP Product Guide (PG116)</i>. • Corrected Bus Index Range definitions for Lockstep Comparison in Lockstep Interface Description. • Clarified registers altered for IDIV instruction. • Corrected PVR assembler mnemonics for MFS instruction. • Updated performance and resource utilization for 2015.1. • Added references to training resources.
10/01/2014 Version 2014.3	
General Updates	Updated for Vivado 2014.3 release: <ul style="list-style-type: none"> • Corrected semantic description for PCMPEQ and PCMPNE in Table 2.1. • Added version 9.4 to MicroBlaze release version code in PVR. • Included description of external program trace, new in version 9.4

Section	Revision Summary
04/02/2014 Version 2014.1	
General Updates	Updated for Vivado 2014.1 release: <ul style="list-style-type: none"> • Added v9.3 to MicroBlaze release version code in PVR. • Clarified availability and behavior of stack protection registers. • Corrected description of LMB instruction and data bus exception. • Included description of extended debug features, new in version 9.3: performance monitoring, program trace and non-intrusive profiling. • Included definition of Reset Mode signals, new in version 9.3. • Clarified how the AXI4-Stream TLAST signal is handled. • Added UltraScale and updated performance and resource utilization for 2014.1.
12/18/2013 Version 2013.4	
General Updates	Updated for Vivado 2013.4 release.
10/02/2013 Version 2013.3	
General Updates	Updated for Vivado 2013.3 release.
06/19/2013 Version 2013.2	
General Updates	Updated for Vivado 2013.2 release.
03/20/2013 Version 2013.1	
General Updates	Initial Xilinx release. This User Guide is derived from UG081.

Please Read: Important Legal Notices

The information presented in this document is for informational purposes only and may contain technical inaccuracies, omissions, and typographical errors. The information contained herein is subject to change and may be rendered inaccurate for many reasons, including but not limited to product and roadmap changes, component and motherboard version changes, new model and/or product releases, product differences between differing manufacturers, software changes, BIOS flashes, firmware upgrades, or the like. Any computer system has risks of security vulnerabilities that cannot be completely prevented or mitigated. AMD assumes no obligation to update or otherwise correct or revise this information. However, AMD reserves the right to revise this information and to make changes from time to time to the content hereof without obligation of AMD to notify any person of such revisions or changes. THIS INFORMATION IS PROVIDED "AS IS." AMD MAKES NO REPRESENTATIONS OR WARRANTIES WITH RESPECT TO THE CONTENTS HEREOF AND ASSUMES NO RESPONSIBILITY FOR ANY INACCURACIES, ERRORS, OR OMISSIONS THAT MAY APPEAR IN THIS INFORMATION. AMD SPECIFICALLY

DISCLAIMS ANY IMPLIED WARRANTIES OF NON-INFRINGEMENT, MERCHANTABILITY, OR FITNESS FOR ANY PARTICULAR PURPOSE. IN NO EVENT WILL AMD BE LIABLE TO ANY PERSON FOR ANY RELIANCE, DIRECT, INDIRECT, SPECIAL, OR OTHER CONSEQUENTIAL DAMAGES ARISING FROM THE USE OF ANY INFORMATION CONTAINED HEREIN, EVEN IF AMD IS EXPRESSLY ADVISED OF THE POSSIBILITY OF SUCH DAMAGES.

AUTOMOTIVE APPLICATIONS DISCLAIMER

AUTOMOTIVE PRODUCTS (IDENTIFIED AS "XA" IN THE PART NUMBER) ARE NOT WARRANTED FOR USE IN THE DEPLOYMENT OF AIRBAGS OR FOR USE IN APPLICATIONS THAT AFFECT CONTROL OF A VEHICLE ("SAFETY APPLICATION") UNLESS THERE IS A SAFETY CONCEPT OR REDUNDANCY FEATURE CONSISTENT WITH THE ISO 26262 AUTOMOTIVE SAFETY STANDARD ("SAFETY DESIGN"). CUSTOMER SHALL, PRIOR TO USING OR DISTRIBUTING ANY SYSTEMS THAT INCORPORATE PRODUCTS, THOROUGHLY TEST SUCH SYSTEMS FOR SAFETY PURPOSES. USE OF PRODUCTS IN A SAFETY APPLICATION WITHOUT A SAFETY DESIGN IS FULLY AT THE RISK OF CUSTOMER, SUBJECT ONLY TO APPLICABLE LAWS AND REGULATIONS GOVERNING LIMITATIONS ON PRODUCT LIABILITY.

Copyright

© Copyright 2013-2025 Advanced Micro Devices, Inc. AMD, the AMD Arrow logo, Artix, Kintex, Spartan, Virtex, Vivado, Vitis, UltraScale, UltraScale+, Versal, Zynq, and combinations thereof are trademarks of Advanced Micro Devices, Inc. Other product names used in this publication are for identification purposes only and may be trademarks of their respective companies.